

# PERI Rental Criteria

## LICO Column Formwork



**Contact**

**PERI GmbH**  
**Formwork Scaffolding**  
**Engineering**

P.O. Box 1264  
 89264 Weißenhorn  
 Phone +49 (0) 7309.950-0  
 Fax +49 (0) 7309.951-0  
 rental-criteria@peri.de

Content	Page
Frame	2
Concreting platform	6
Railing post	9
Glossary	10

Change	Date   Initial	Page
New Version	11/2015   fw	

# PERI Rental Criteria

## LICO Column Formwork



Column element	No.	Description	Article number
----------------	-----	-------------	----------------

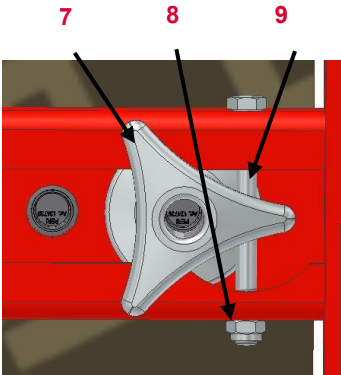
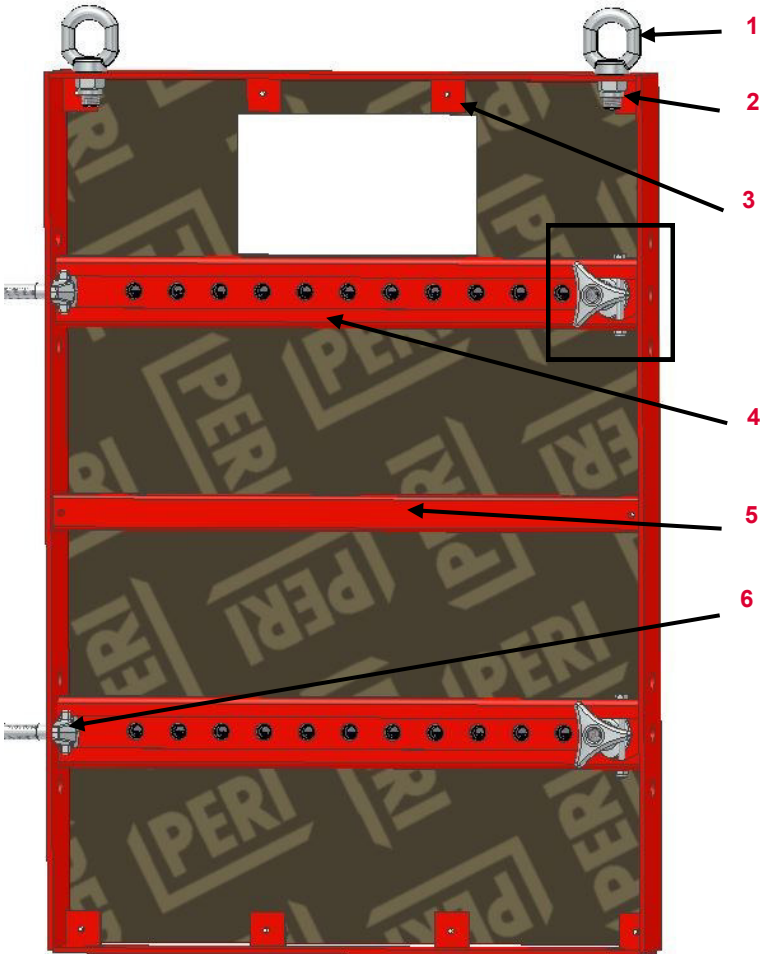













1	Loop Bolt M 20	710130
2	Hex nut	781053
3	„Lasche“	111672
4	„Lochstrebe“	111667
5	Push-pull prop brace	111666
6	Column Tie Bolt	111682
7	Column Tie Nut	111679
8	Hex nut	711071
9	Bolt	115530

Valid for	Article number
Column element LICO 700x 3000	111683
Column element LICO 700x 1000	111957
Column element LICO 700x 500	111964

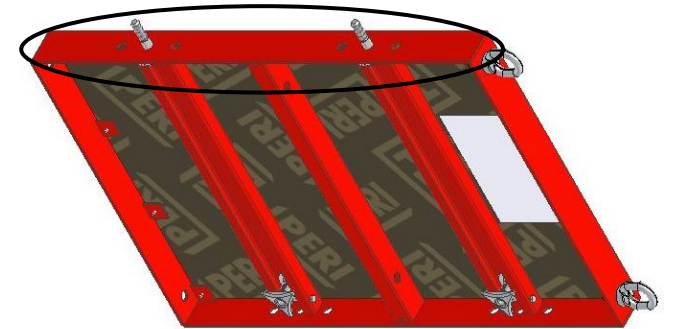
# PERI Rental Criteria

## LICO Column Formwork













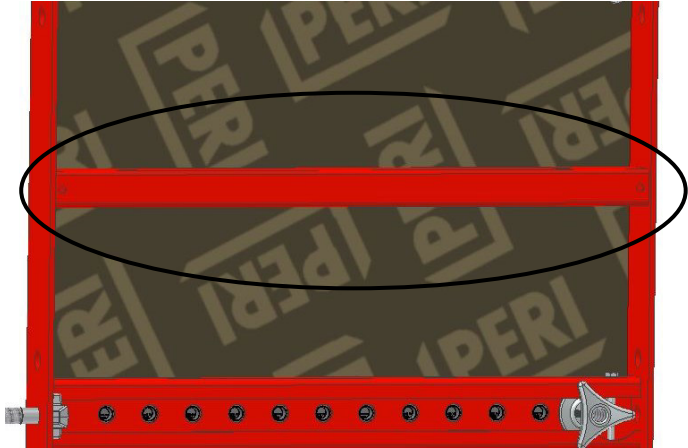

Frame	Description	Instruction	Billing Condition	Type
	<p><b>17.30.01 Front profile bent</b></p> <ul style="list-style-type: none"> <li>■ If possible</li> <li>■ Or if not possible</li> </ul>	<ul style="list-style-type: none"> <li>■ </li> <li>■ </li> </ul>	<p>088244</p> <ul style="list-style-type: none"> <li>■ </li> <li>■ </li> </ul>	<ul style="list-style-type: none"> <li>■ </li> <li>■ </li> </ul>
	<p><b>17.30.02 Length profile bent</b></p> <ul style="list-style-type: none"> <li>■ If possible</li> <li>■ Or if not possible</li> </ul>	<ul style="list-style-type: none"> <li>■ </li> <li>■ </li> </ul>	<p>088244</p> <ul style="list-style-type: none"> <li>■ </li> <li>■ </li> </ul>	<ul style="list-style-type: none"> <li>■ </li> <li>■ </li> </ul>

# PERI Rental Criteria

## LICO Column Formwork











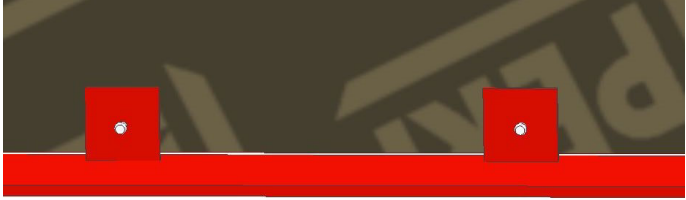

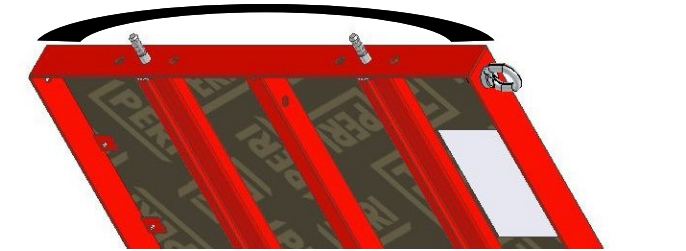

Frame	Description	Instruction	Billing Condition	Type
	<p><b>17.30.03 Bented holes brace</b></p> <ul style="list-style-type: none"> <li>■ If possible, column tie nut function</li> <li>■ Or if not possible</li> </ul>	<p>     </p>	<p>  088244              </p>	<p>     </p>
	<p><b>17.30.04 Bented brace</b></p> <ul style="list-style-type: none"> <li>■ If possible</li> <li>■ Or if not possible</li> </ul>	<p>     </p>	<p>  088244              </p>	<p>     </p>

# PERI Rental Criteria

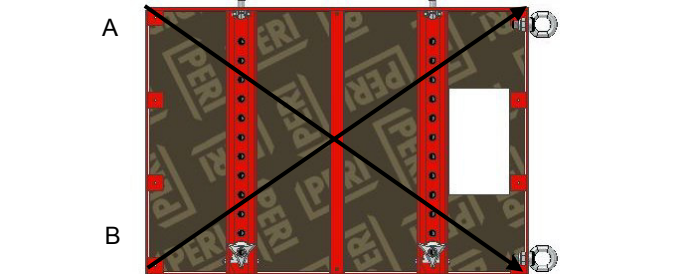
## LICO Column Formwork



Frame	Description	Instruction	Billing Condition	Type
	<p><b>17.30.05 “Lasche” bent, lost</b></p>			
	<p><b>17.30.06 Frame bent</b></p> <ul style="list-style-type: none"> <li>■ &gt; 5 mm</li> </ul>			
	<p><b>17.30.07 Frame bent diagonally</b></p> <ul style="list-style-type: none"> <li>■ Difference A to B &lt; 5 mm</li> </ul>			

# PERI Rental Criteria

## LICO Column Formwork



Concreting platform LICO (115894)	No.	Description	Article number
-----------------------------------	-----	-------------	----------------

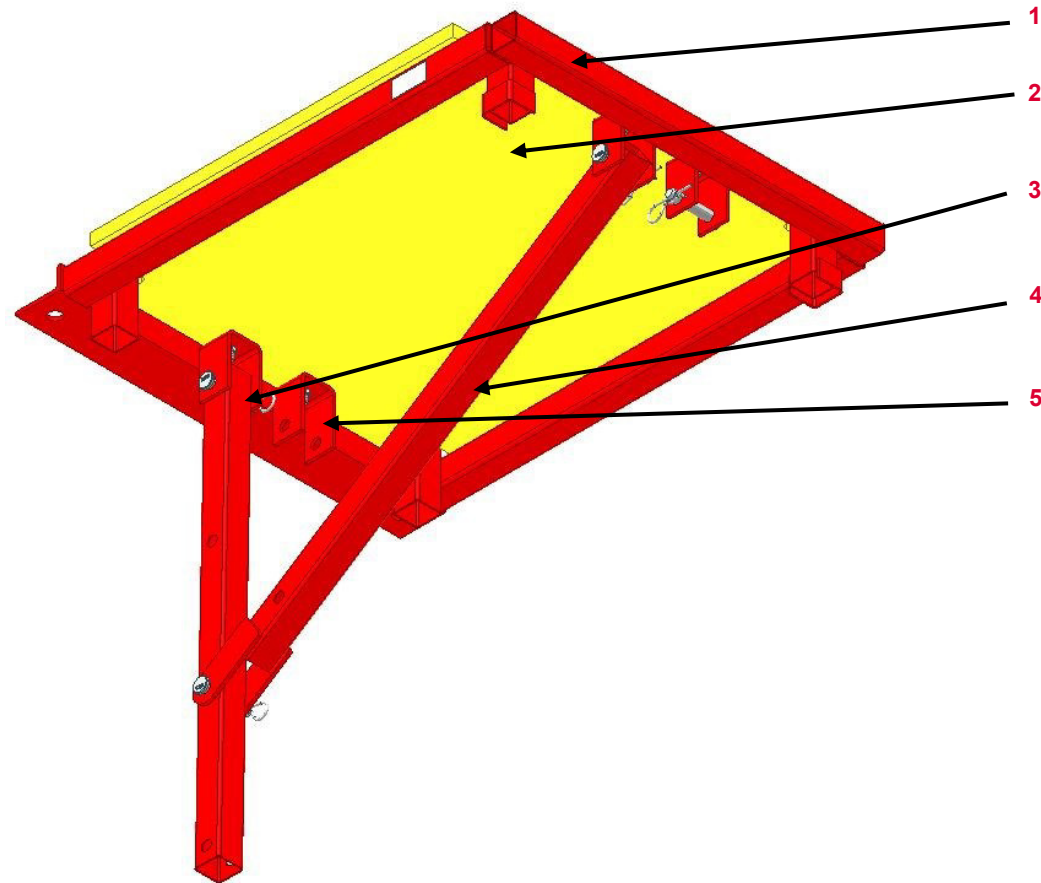













1	Concreting platform LICO frame	115895
2	Concreting platform LICO surface	115896
3	„Vertikalstrebe“	115907
4	„Diagonalstrebe“	115911
5	„Strebenaufnahme“	115904



# PERI Rental Criteria

## LICO Column Formwork









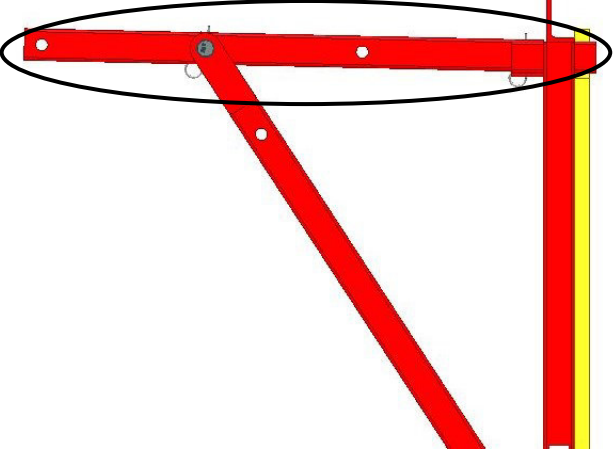

Concreting platform	Description	Instruction	Billing Condition	Type
	<b>17.30.08 Surface</b>	<ul style="list-style-type: none"> <li>■ Worn  Surface LICO (115896) Bolt (710295)</li> </ul>		
	<ul style="list-style-type: none"> <li>■ Or broken</li> </ul>	<ul style="list-style-type: none"> <li> Surface LICO (115896) Bolt (710295)</li> </ul>		
	<b>17.30.09 „Strebenaufnahme“ bent</b>	<ul style="list-style-type: none"> <li>■ If possible </li> </ul>		
	<ul style="list-style-type: none"> <li>■ Or if not possible</li> </ul>	<ul style="list-style-type: none"> <li></li> </ul>		

# PERI Rental Criteria

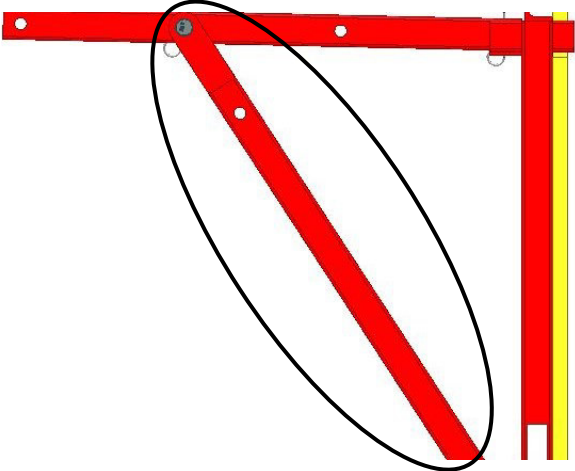
## LICO Column Formwork





Concreting platform	Description	Instruction	Billing Condition	Type
	<p><b>17.30.10 „Vertikalstrebe“ bent</b></p>	 <p>Vertikalstrebe (115907) Pin (106031) Cotter pin (018060)</p>		
	<p><b>17.30.11 „Diagonalstrebe“ bent</b></p>	 <p>Diagonalstrebe (115911) Pin (106031) Cotter pin (018060)</p>		



# PERI Rental Criteria

## LICO Column Formwork



















Railing post HSGP-2 (116292)	Description	Instruction	Billing Condition	Type
	<b>17.30.12 Slider deformed, lost</b>	 Slider (115673)	 088227	
	<b>17.30.13 Bracket broken</b>		 088226	
	<b>17.30.14 Bent, deformed</b> ■ > 5 mm			

# PERI Rental Criteria

## Glossar Icons



Icon	Significance	Icon	Significance	Icon	Significance
	Not OK—material is scrap		Billing necessary (customer)		Optical damage
	OK—material stays in rental park		No Billing necessary		Functional damage
	Scrap material—it's not permitted to hand out the material because of safety aspects		Shorten the material		Functional damage—it's <b>not</b> permitted to hand out the material
	Repair according the Instruction		Mark the material		Static damage—it's <b>not</b> permitted to hand out the material
	Fix material cold– Afterwards check weld seams and bordering components		Replace damaged material		
	Repair after local economic efficiency calculation		Replace missing material		
	Clean the material				