

PERI Rental Criteria

PERI UP Facade Scaffold Easy



Contact

PERI GmbH
Formwork Scaffolding
Engineering
 P.O. Box 1264
 89264 Weissenhorn, Germany
 Phone +49 (0) 7309.950-0
 Fax +49 (0) 7309.951-0
 rental-criteria@peri.de

Content	Page	Changes	Date Initial	Page
Steel Deck EDS	2	New Version	03/2017 fw	
Combi Deck EDW	6			
Frame parts	9			
Access Deck Ladder Access	12			
Diagonal	17			
Guardrail	19			
Accessories	23			
Glossary	27			

PERI Rental Criteria

PERI UP Facade Scaffold Easy



Steel Deck EDS	Nr.	Description	Article number
----------------	-----	-------------	----------------

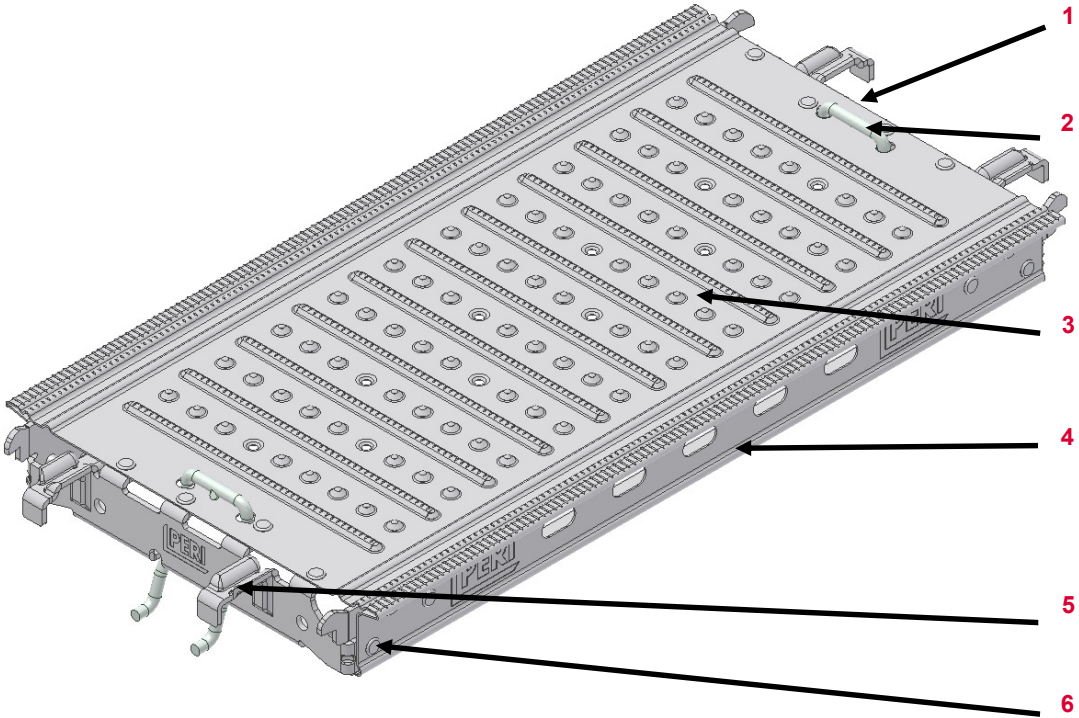

1	Hinge EDS	129808
2	Safety hook	108716
3	Deck	
4	Side profile	
5	Connection Bracket	
6	Niet 6,0x 10	723058

Valid for	Article number
Steel Deck EDS 33x67	130450
Steel Deck EDS 33x100	130448
Steel Deck EDS 33x150	130445
Steel Deck EDS 33x200	130441
Steel Deck EDS 33x250	130438
Steel Deck EDS 33x300	129272

PERI Rental Criteria

PERI UP Facade Scaffold Easy



Steel Deck EDS	Description	Instruction	Billing condition	Type
----------------	-------------	-------------	-------------------	------



33.25.01 Edge profile bent

- Insertion of decking possible and no damage to Tox- Connection



- Or insertion not possible



- Damage to Tox- Connection



33.25.02 Deck bent

- < permitted bent (L/250)



- Or > permitted bent (L/250)

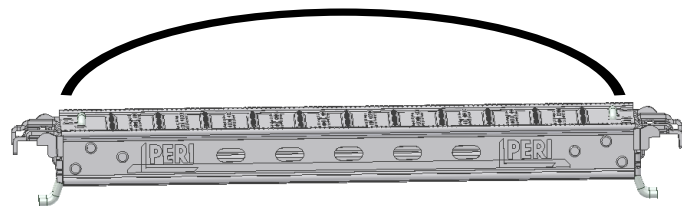











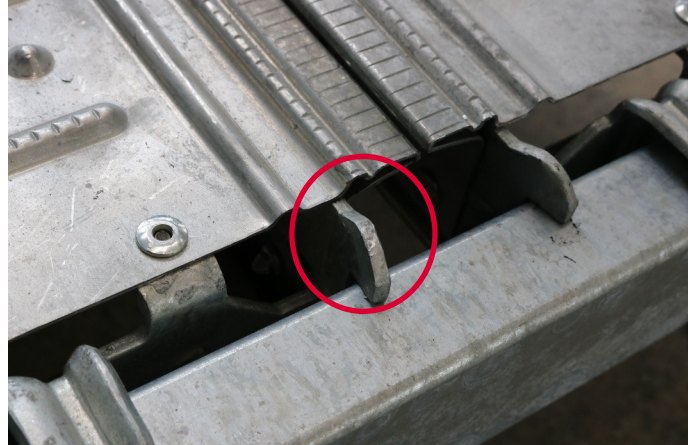

Article	Perm. bent
EDS 67 100	5 mm
EDS 150	6 mm
EDS 200	8 mm
EDS 250	10 mm
EDS 300	12 mm

PERI Rental Criteria

PERI UP Facade Scaffold Easy









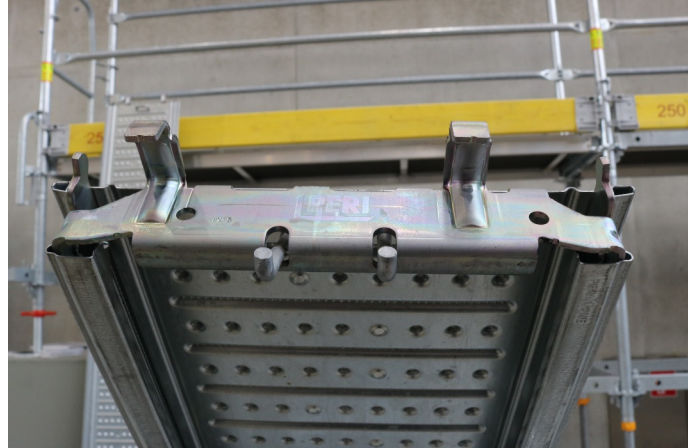

Steel Deck EDS	Description	Instruction	Billing condition	Type
	33.25.03 Claw bent			
	<ul style="list-style-type: none"> ■ ≤ 5 mm 			
	<ul style="list-style-type: none"> ■ Or with cracks in claw 			
	33.25.04 Hook at Hinge bent			
	<ul style="list-style-type: none"> ■ Without cracks in material 			
<ul style="list-style-type: none"> ■ Or with cracks in material 				

PERI Rental Criteria

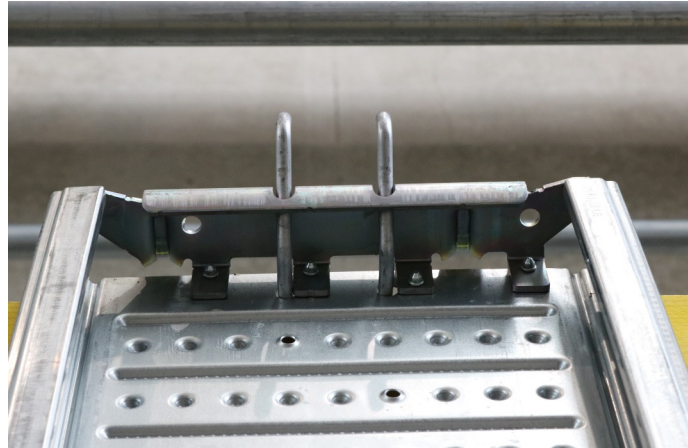
PERI UP Facade Scaffold Easy



Steel Deck EDS	Description	Instruction	Billing condition	Type
	<p>33.25.05 Complete hinge bent</p>			
	<p>33.25.06 Safety bracket bent unusable</p>			

PERI Rental Criteria

PERI UP Facade Scaffold Easy



Combi Deck EDW

Nr.	Description	Article number
-----	-------------	----------------

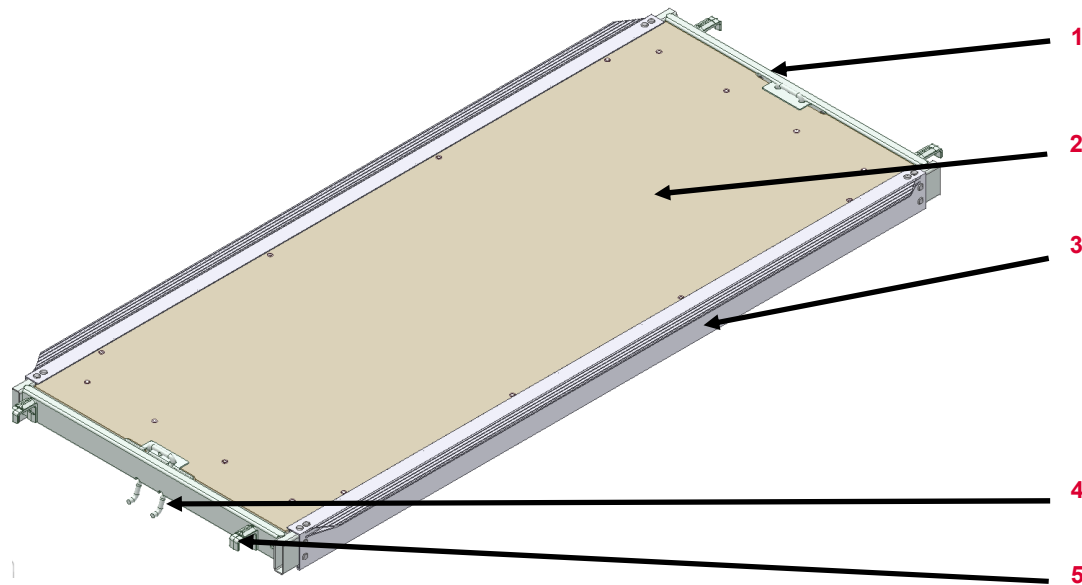



















1	Hinge EDW	130308
2	Deck	
3	Side profile	
4	Safety bracket	
5	Connection bracket	

Valid for	Article number
Combi Deck EDW 150	130321
Combi Deck EDW 200	130317
Combi Deck EDW 250	130313
Combi Deck EDW 300	130309

PERI Rental Criteria

PERI UP Facade Scaffold Easy























Combi Deck EDW	Description	Instruction	Billing condition	Type
	33.25.07 Edge profile bent	<ul style="list-style-type: none"> ■ Insertion of deck possible   		
	<ul style="list-style-type: none"> ■ Or if impossible 	 		
	<ul style="list-style-type: none"> ■ Or cracks in material 	 		
	33.25.08 Deck	<ul style="list-style-type: none"> ■ Worn  		
	<ul style="list-style-type: none"> ■ Broken through force 			

PERI Rental Criteria

PERI UP Facade Scaffold Easy



Combi Deck EDW	Description	Instruction	Billing condition	Type
	33.25.09 Claw bent <ul style="list-style-type: none"> ■ ≤ 5 mm and no cracks in claw 			
	<ul style="list-style-type: none"> ■ Or > 5 mm ■ Or cracks in claw 	 130308		
	33.25.10 Safety bracket <ul style="list-style-type: none"> ■ Bent 	 130308		
	<ul style="list-style-type: none"> ■ Or missing 	 130308		
	33.25.11 Welding broken at strut <ul style="list-style-type: none"> ■ With deformation of strut 			
	<ul style="list-style-type: none"> ■ Or without deformation 			

PERI Rental Criteria

PERI UP Facade Scaffold Easy



Head Frame EVH Easy Frame EVF Easy Frame EVB Tube EVR	Nr.	Description	Article number
---	-----	-------------	----------------

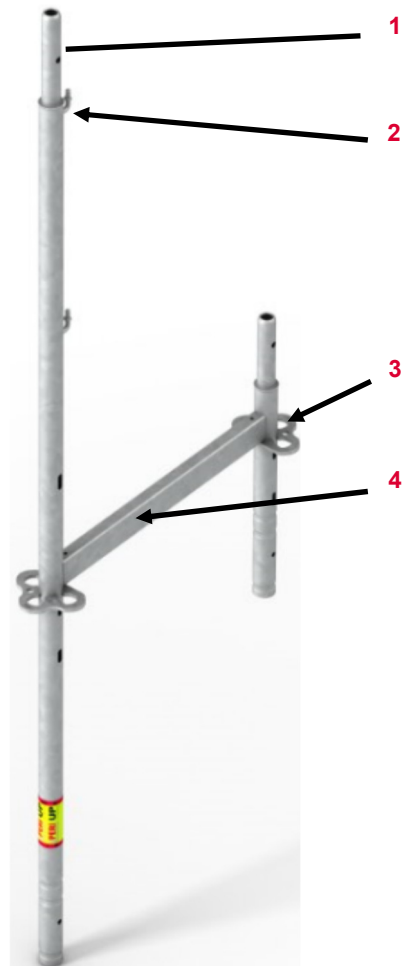













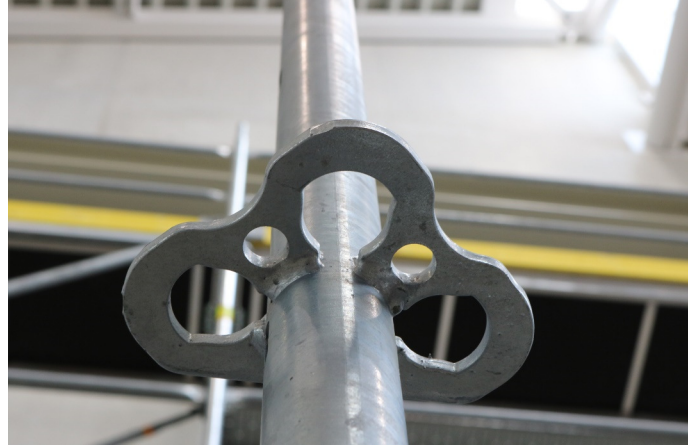

1	Spigot
2	Guardrail hook
3	3/4 Rosett
4	Horizontal tube

Valid for	Item number
Head Frame EVH 67	129314
Head Frame EVH 100	130804
Easy Frame EVF 67	130466
Easy Frame EVF 100	130860
Easy Frame EVB 67	130518
Easy Frame EVB 100	130858
Tube EVR 150	130481
Base Adjust EVA 64/50	130522
Base Adjust EVA 67/100	130526
Base Adjust EVA 100/50	130854
Base Adjust EVA 100/100	130856
Guardrail Post EVP	130512
Console Bracket ECM 33	130378
Console Bracket ECM 67	130372
Console Bracket ECM 100	130365
Easy Base Post EVS 124	130619
Easy Post EVM 200	130621

PERI Rental Criteria

PERI UP Facade Scaffold Easy



















Frame parts	Description	Instruction	Billing condition	Type
	<p>33.25.12 Spigot Junction bent</p> <ul style="list-style-type: none"> ■ All visible deformations 			
	<p>33.25.13 Rosett bent</p> <ul style="list-style-type: none"> ■ If possible ■ Or welding cracked ■ Or bent > 20 mm 	  	  	  

PERI Rental Criteria

PERI UP Facade Scaffold Easy



Frame parts	Description	Instruction	Billing condition	Type
	33.25.14 Guard rail bent			
	<ul style="list-style-type: none"> ■ If possible 			
	<ul style="list-style-type: none"> ■ Cracks in material welding 			
	33.25.15 Dent horizontal tube			
	<ul style="list-style-type: none"> ■ $\varnothing \leq 3 \text{ cm}$ 			
	<ul style="list-style-type: none"> ■ Or crack 			
	<ul style="list-style-type: none"> ■ Or edges of horizontal tube are affected 			

PERI Rental Criteria

PERI UP Facade Scaffold Easy



Ladder Access EAW Access Deck EAW		Nr.	Description	Article number
-------------------------------------	--	-----	-------------	----------------

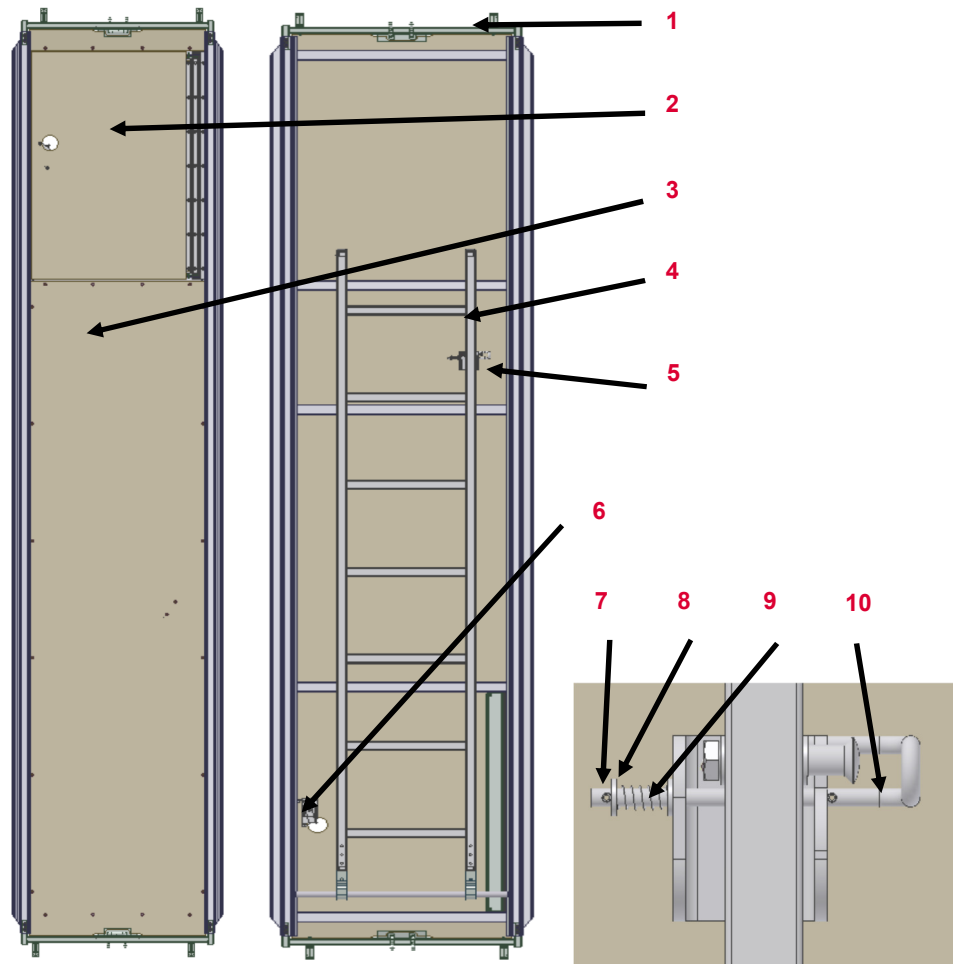

1	Hinge	130308
2	Access Hatch	130412
3	Deck	
4	Ladder EAL	130419
5	Ladder Connection Bracket	130423
6	Latch UAL	115566
7	Dowel Pin	130356
8	Disc	721633
9	Spring	130386
10	Safety hook	130422

Valid for	Article number
Ladder access EAW-L 250	130431
Ladder access EAW-L 300	130425
Access deck EAW 200	130426

PERI Rental Criteria

PERI UP Facade Scaffold Easy



Ladder Access EAW Access Deck EAW	Description	Instruction	Billing condition	Type
-------------------------------------	-------------	-------------	-------------------	------



33.25.16 Decking/Hatch

- Worn
- Or broken through force



130412 (Access Hatch)
130407 (Deck EAW 300)
130427 (Deck EAW 250)



130412 (Access Hatch)
130407 (Deck EAW 300)
130427 (Deck EAW 250)

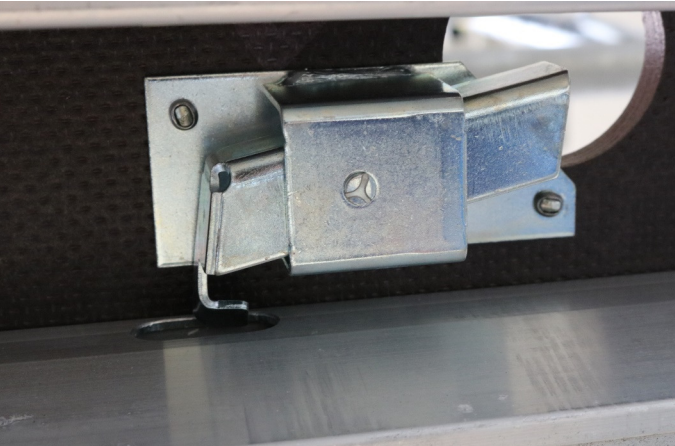

33.25.17 Latch not functional





















- Worn
- Or damaged due to force



PERI Rental Criteria

PERI UP Facade Scaffold Easy

















Ladder Access EAW Access Deck EAW	Description	Instruction	Billing condition	Type
	33.25.18 Ladder hinge			
	<ul style="list-style-type: none"> ■ Not functional because of weariness 			
	<ul style="list-style-type: none"> ■ Or not functional due to force 			
<ul style="list-style-type: none"> ■ Or parts missing 				
	33.25.19 Strut bent			
	<ul style="list-style-type: none"> ■ If possible 			
	<ul style="list-style-type: none"> ■ Or if welding cracked 			
<ul style="list-style-type: none"> ■ Or kink 				

PERI Rental Criteria

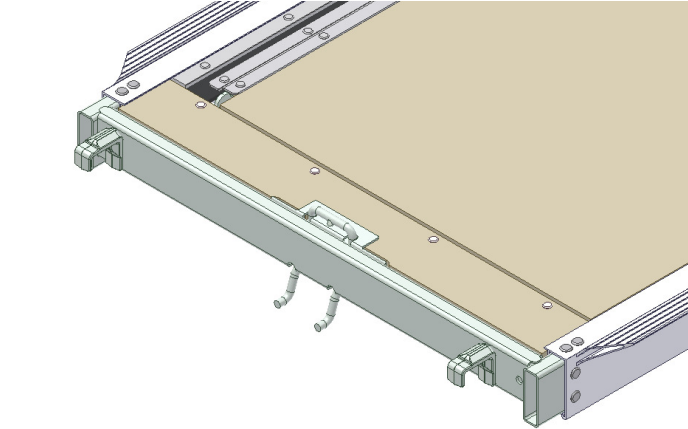
PERI UP Facade Scaffold Easy



Ladder Access EAW Access Deck EAW	Description	Instruction	Billing condition	Type
	33.25.20 Claw bent			
	<ul style="list-style-type: none"> ■ ≤ 5 mm 			
	<ul style="list-style-type: none"> ■ Or > 5 mm 			
<ul style="list-style-type: none"> ■ Or cracks in claw 				
	33.25.21 Hinge bent not usable			
		130308 (Hinge) 722318 (Rivet 6,0 x 10)		

PERI Rental Criteria

PERI UP Facade Scaffold Easy



Access Deck EAW	Description	Instruction	Billing condition	Type	
	33.25.22 Bracket of ladder bent	■ If possible			
	■ Or if not possible	130417 (Bracket Easy) 104280 (Rivet 6,0x12)			
	33.25.23 Ladder steps bent	■ No cracks in welding			
	■ Or with cracks				
	■ Or kink				

PERI Rental Criteria

PERI UP Facade Scaffold Easy



Face Brace EBF	Nr.	Description	Article number
----------------	-----	-------------	----------------

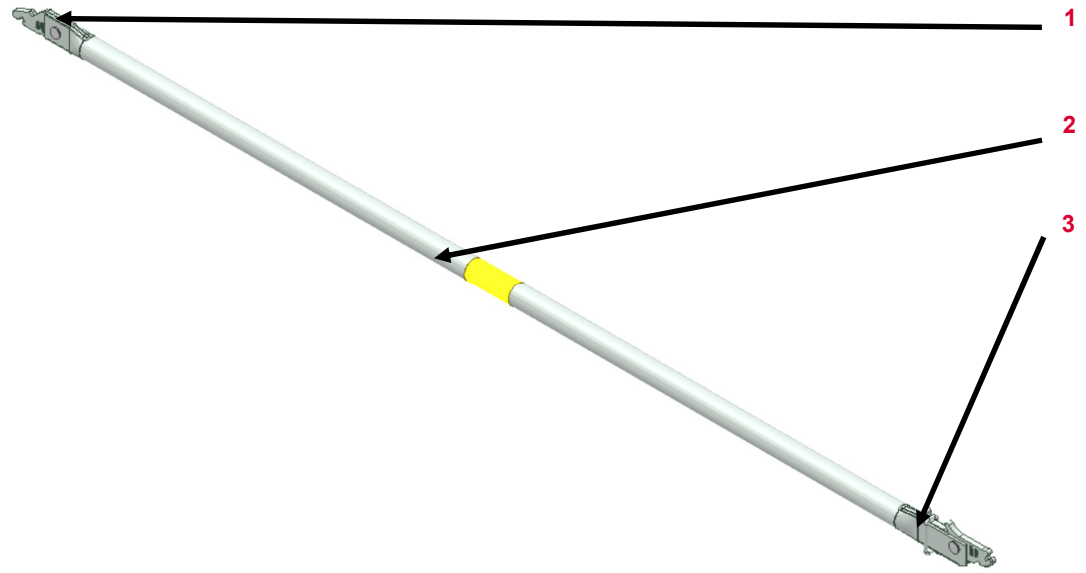

1	Diagonal head bottom
2	Tube
3	Diagonal head top

Valid for	Item number
Face Brace EBF 150/200	130162
Face Brace EBF 200/200	130171
Face Brace EBF 250/200	130180
Face Brace EBF 300/200	130189

PERI Rental Criteria

PERI UP Facade Scaffold Easy



Face Brace EBF	Description	Instruction	Billing condition	Type
----------------	-------------	-------------	-------------------	------



33.25.24 Diagonal head not usable

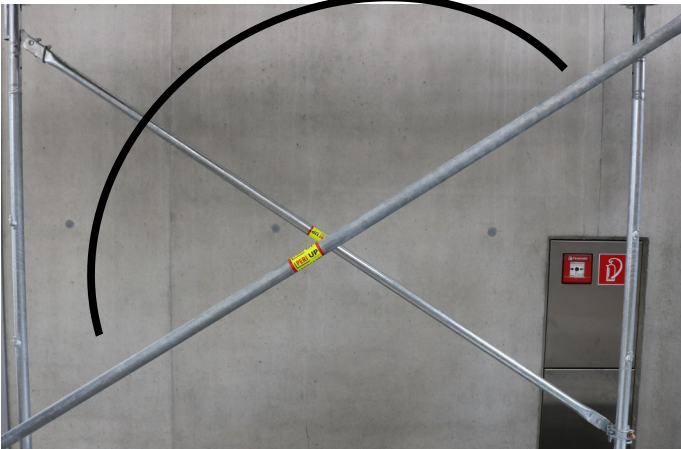

33.25.25 Diagonals bent

■ ≤ permitted bent (L/500)



■ Or > permitted bent (L/500)



Article	Perm. bent
Face Brace EBF 150/200	4 mm
Face Brace EBF 200/200	5 mm
Face Brace EBF 250/200	6 mm
Face Brace EBF 300/200	7 mm

PERI Rental Criteria

PERI UP Facade Scaffold Easy



Guardrails EPG	Nr.	Description	Article number
----------------	-----	-------------	----------------



- | | |
|---|-----------|
| 1 | Connector |
| 2 | Tube |

Gültig für	Artikelnummer
Guardrails EPG 67	130191
Guardrails EPG 100	130193
Guardrails EPG 150	130195
Guardrails EPG 200	130197
Guardrails EPG 250	130199
Guardrails EPG 300	130201

PERI Rental Criteria

PERI UP Facade Scaffold Easy



Guardrails EPG	Description	Instruction	Billing condition	Type
----------------	-------------	-------------	-------------------	------



33.25.26 Connector bent

■ If possible



■ If not possible



33.25.27 Guardrails bent

■ > permitted bent (L/250)



Article	Perm. bent
Guardrails EPG 67	3 mm
Guardrails EPG 100	4 mm
Guardrails EPG 150	6 mm
Guardrails EPG 200	8 mm
Guardrails EPG 250	10 mm
Guardrails EPG 300	12 mm

PERI Rental Criteria

PERI UP Facade Scaffold Easy



Stop- and Handrails EPF	Nr.	Description	Article number
-------------------------	-----	-------------	----------------

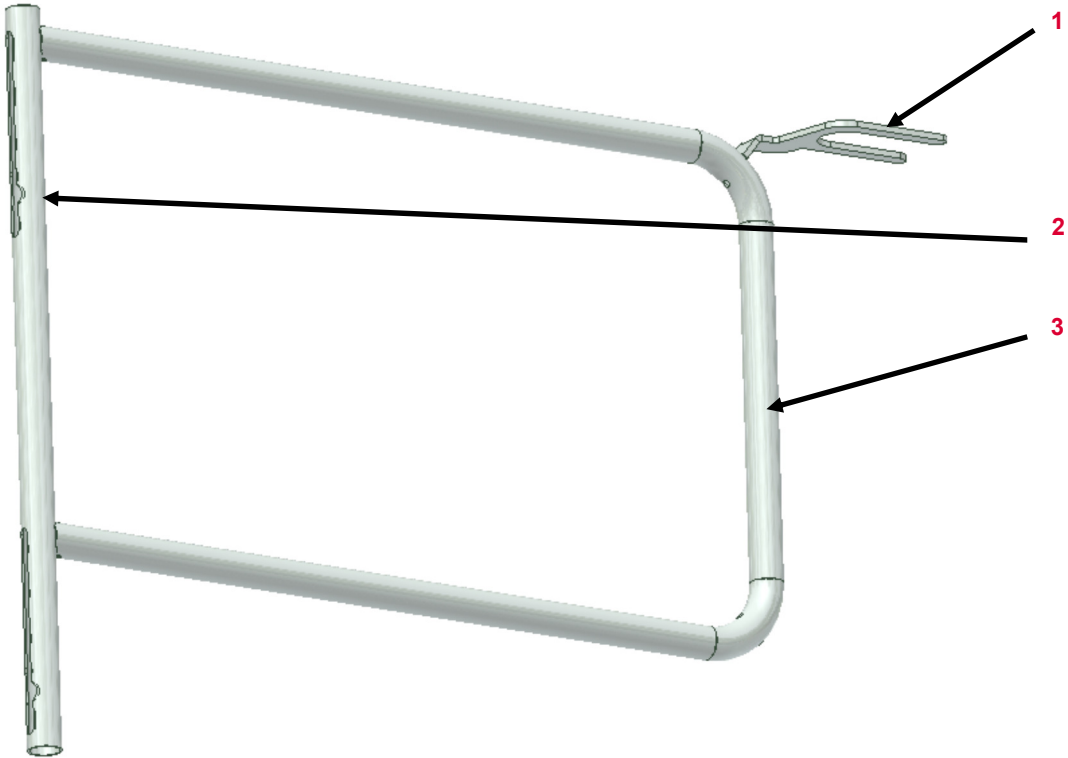

1	Fork
2	Tube
3	Frame

PERI Rental Criteria

PERI UP Facade Scaffold Easy



Stop- and Handrails EPF	Description	Instruction	Billing condition	Type
-------------------------	-------------	-------------	-------------------	------



33.25.28 Fork bent

- If possible
- Or if not possible



33.25.29 Tube squashed









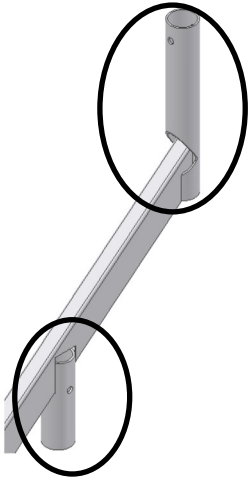

- Insertion possible
- Or no longer possible

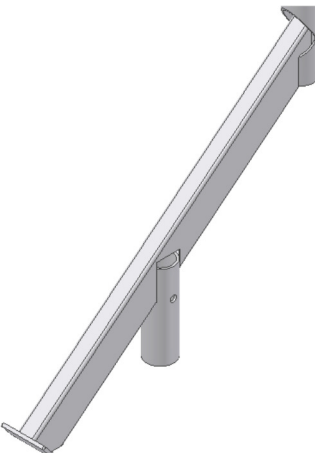

PERI Rental Criteria

PERI UP Facade Scaffold Easy





















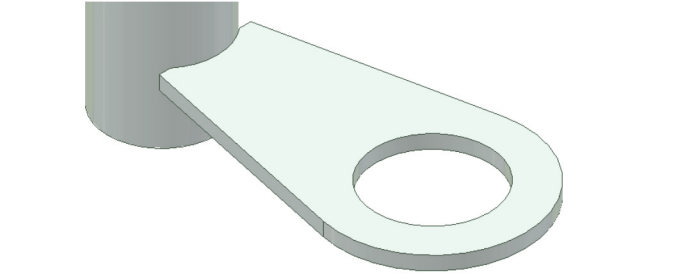

Connection Protect Panel EPC (130385)	Description	Instruction	Billing condition	Type
	<p>33.25.30 Connection tubes bent squashed</p> <ul style="list-style-type: none"> ■ Every visible deformation 			
	<p>33.25.31 Dent in tube</p> <ul style="list-style-type: none"> ■ $\varnothing > 3$ cm ■ Or edges affected 	 	 	 

PERI Rental Criteria

PERI UP Facade Scaffold Easy











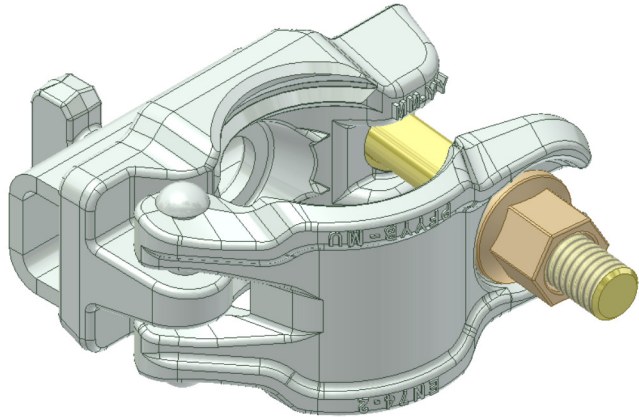

Protection Panel Post EPS (130532)	Description	Instruction	Billing condition	Type
	<p>33.25.32 Guardrail hook bent</p> <ul style="list-style-type: none"> ■ If possible ■ Or if not possible 	<ul style="list-style-type: none"> ■ If possible:  ■ Or if not possible:   	<ul style="list-style-type: none"> ■ If possible:  ■ Or if not possible:  	<ul style="list-style-type: none"> ■ If possible:  ■ Or if not possible: 
	<p>33.25.33 Spigot connection bent</p> <ul style="list-style-type: none"> ■ All visible deformations 	<ul style="list-style-type: none"> ■ All visible deformations:   	<ul style="list-style-type: none"> ■ All visible deformations:  	<ul style="list-style-type: none"> ■ All visible deformations: 
	<p>33.25.34 Junction sheet bent</p> <ul style="list-style-type: none"> ■ If possible ■ Or if not possible 	<ul style="list-style-type: none"> ■ If possible:  ■ Or if not possible:   	<ul style="list-style-type: none"> ■ If possible:  ■ Or if not possible:  	<ul style="list-style-type: none"> ■ If possible:  ■ Or if not possible: 

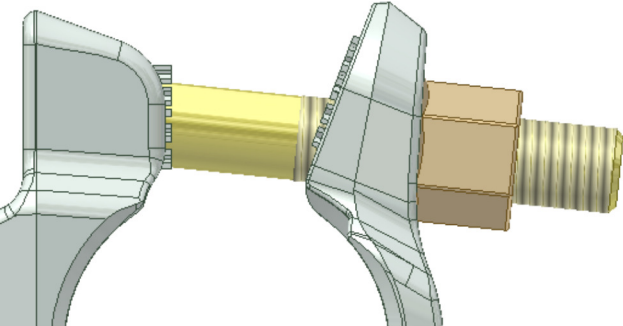
PERI Rental Criteria

PERI UP Facade Scaffold Easy

















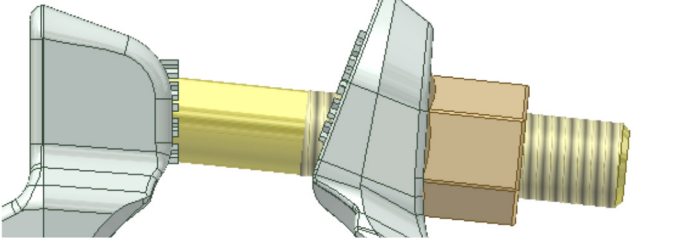

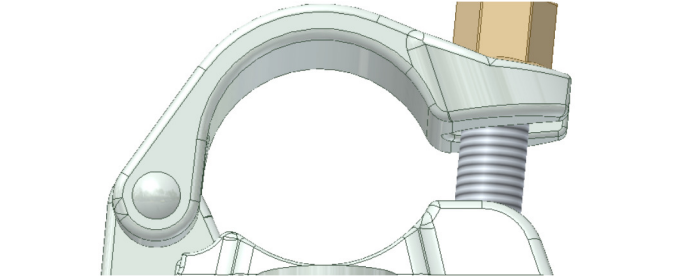

Wall Tie Holder EWC (130964)	Description	Instruction	Billing condition	Type
	33.25.35 Hinge not functional			
	<ul style="list-style-type: none"> ■ Worn 			
	33.25.36 Hammer head bolt Nut			
	<ul style="list-style-type: none"> ■ Missing 		<p>131316 (Hammer head bolt) 710340 (Nut)</p> 	
<ul style="list-style-type: none"> ■ Or damaged 		<p>131316 (Hammer head bolt) 710340 (Nut)</p> 		

PERI Rental Criteria

PERI UP Facade Scaffold Easy



















Guardrail Coupler EPR (130434)	Description	Instruction	Billing condition	Type
	33.25.37 Guardrail hook bent	<ul style="list-style-type: none"> ■ If possible 		
	<ul style="list-style-type: none"> ■ Or if not possible 			
	33.25.38 Hammer head bolt Nut	<ul style="list-style-type: none"> ■ Missing 		
	<ul style="list-style-type: none"> ■ Or are damaged 			
	33.25.39 Hinge not functional	<ul style="list-style-type: none"> ■ Worn 		
	<ul style="list-style-type: none"> ■ Or damaged due to force 			

PERI Mietkriterien

Glossar Icons



Icon	Significance	Icon	Significance	Icon	Significance
	Not Ok– material is scrap		Billing necessary (customer)		Optical damage
	OK– material stays in rental park		No Billing necessary		Functional damage
	Scrap material– it's not permitted to hand out the material because of safety aspects		Shorten the material		Functional damage— it's not permitted to hand out the material
	Repair according to instruction		Mark the material		Static damage— it's not permitted to hand out the material
	Fix material cold– Afterwards check weld seams and bordering components		Replace damaged material		
	Repair after local economic efficiency calculation		Replace missing material		
	Clean the material				