

PERI Rental Criteria

LGS Weather Protection Roof

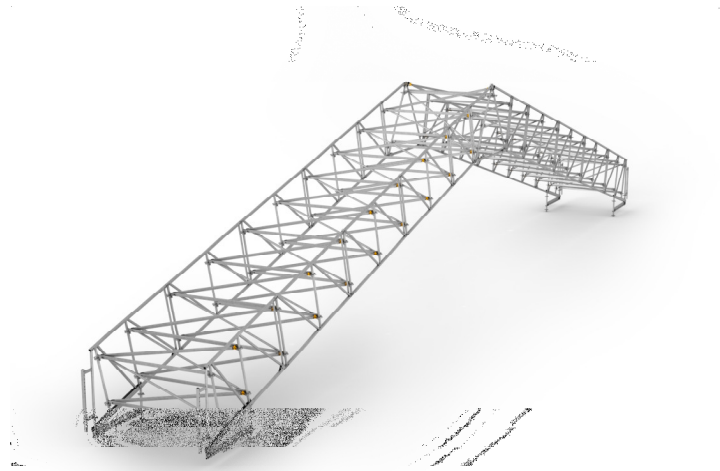

Contact

PERI GmbH
Formwork Scaffolding
Engineering
 P.O. Box 1264
 89264 Weissenhorn, Germany
 Phone +49 (0) 7309.950-0
 Fax +49 (0) 7309.951-0
 rental-criteria@peri.de

Content	Page
LGS Elements	2
Alu Rail URT Ledger	8
Supprt Roller UEW	15
Keder Rail Ridge Rail Eave Rail	16
Keder Connector URK URV	18
Tarpauling Reel URG	20
Reel Connector URG	21
Collar URP	22
Glossary	23

Changes	Date Initial	Page
New Version	06/2017 fw	

PERI Rental Criteria

LGS Weather Protection Roof



LGS Elements	Nr.	Description	Item number
--------------	-----	-------------	-------------

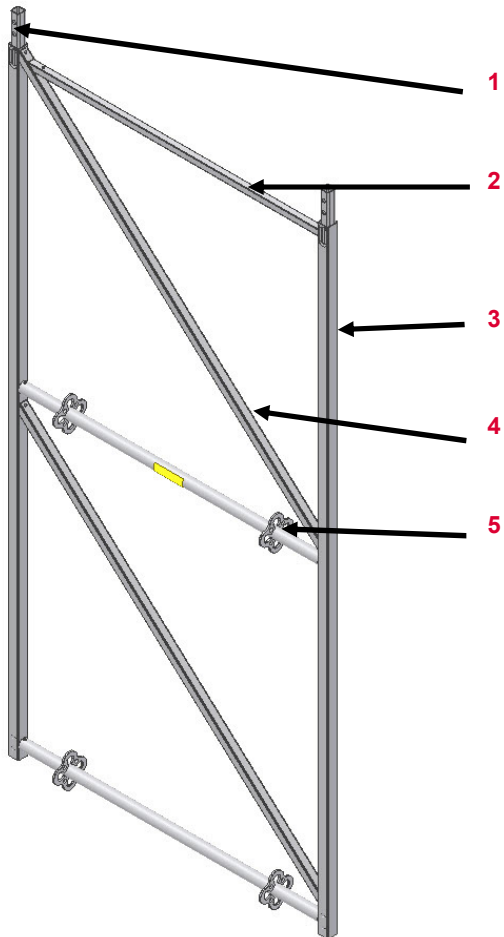



1	Connection
2	Vertical Pipe
3	Outer Pipe
4	Diagonal Pipe
5	Rosett

Gültig für	
LGS– Basic Element URB 300/150	104768
LGS– Eave Element URB 300/150	126483
LGS– Additional Element URB 150/150	104792
LGS– Middle Element URB 150/150	116122
LGS– Ridge Element URR 150	104769
LGS– End Element URB 150	105334

PERI Rental Criteria

LGS Weather Protection Roof











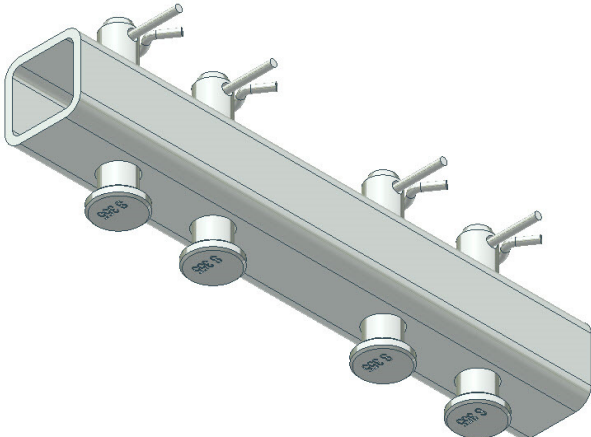





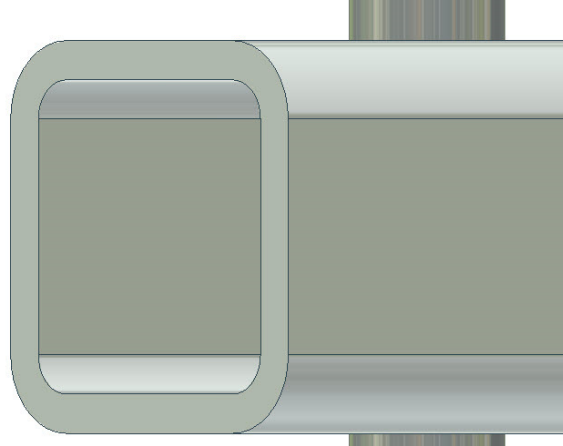

LGS Elements	Description	Instruction	Billing condition	Type
	33.50.01 Junctions bent			
	<ul style="list-style-type: none"> ■ If possible (Connection possible) and no cracks in zinc layer 			
	<ul style="list-style-type: none"> ■ Or no longer possible 			
	<ul style="list-style-type: none"> ■ Or cracks in zinc layer 			
	33.50.02 Rosetts bent			
	<ul style="list-style-type: none"> ■ ≤ 20 mm 			
	<ul style="list-style-type: none"> ■ Or > 20 mm 			
	<ul style="list-style-type: none"> ■ Or cracks in rosette 			

PERI Rental Criteria

LGS Weather Protection Roof



























LGS Connector URC (115978)	Description	Instruction	Billing condition	Type
	33.50.03 Bolt/ Cotter pin			
	<ul style="list-style-type: none"> Missing 	 106031 (Bolt) 018060 (Cotter pin)		
<ul style="list-style-type: none"> Unusable due to violence 	 106031 (Bolt) 018060 (Cotter pin)			
	33.50.04 Pipe bent/dented			
	<ul style="list-style-type: none"> Connection still possible 			
	<ul style="list-style-type: none"> Connection no longer possible 			
<ul style="list-style-type: none"> Cracks in zinc layer 				

PERI Rental Criteria

LGS Weather Protection Roof



Support URS (105399; 104771; 104770)	Description	Instruction	Billing condition	Type
	33.50.05 Rail bent	<ul style="list-style-type: none"> ■ If possible (Insertion of rail possible)  		
	<ul style="list-style-type: none"> ■ Or no longer possible 	 		
	<ul style="list-style-type: none"> ■ Or cracks in zinc layer 	 		
	33.50.06 Rosetts bent	<ul style="list-style-type: none"> ■ ≤ 20 mm  		
	<ul style="list-style-type: none"> ■ Or > 20 mm 	 		
	<ul style="list-style-type: none"> ■ Or cracks in roset 	 		

PERI Rental Criteria

LGS Weather Protection Roof



Ridge Bar UR (128334; 104778; 104981)	Description	Instruction	Billing condition	Type
---------------------------------------	-------------	-------------	-------------------	------

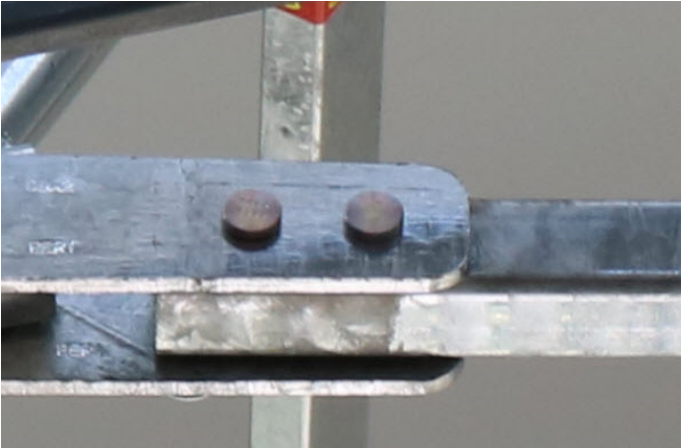

33.50.07 Bolt | Cotter pin | Screws | Nuts

- Missing



- Or unusable due to violence

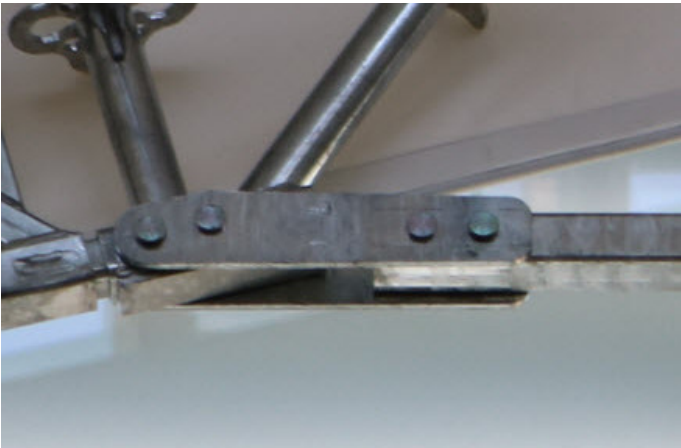

33.50.08 Brackets bent

- If possible















- Or if no longer possible

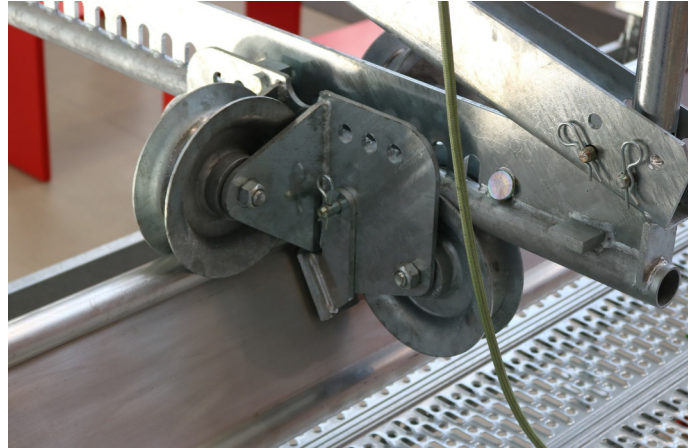

PERI Rental Criteria

LGS Weather Protection Roof



Wheel URW (104777)	Description	Instruction	Billing condition	Type
	<p>33.50.09 Roll bent</p> <ul style="list-style-type: none"> ■ Function not limited and function lifting protection not limited ■ Or function limited 	<ul style="list-style-type: none">   104776 (roll) 	<ul style="list-style-type: none">   	<ul style="list-style-type: none">  
	<p>33.50.10 Bolt Cotter pin</p> <ul style="list-style-type: none"> ■ Missing ■ Or unusable due to violence 	<ul style="list-style-type: none">   	<ul style="list-style-type: none">   	<ul style="list-style-type: none">  

PERI Rental Criteria

LGS Weather Protection Roof



Alu Rail URT	Nr.	Description	Item number
--------------	-----	-------------	-------------

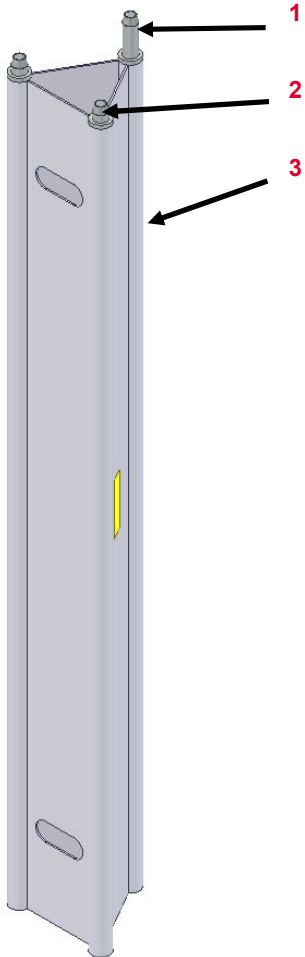















1	Connector long	104800
2	Connector short	104848
3	Guide rail	

Valid for	
Alu- Rail URT 150	104790
Alu- Rail URT 200	104791
Alu- Rail URT 250	104796
Alu- Rail URT 300	104797

PERI Rental Criteria

LGS Weather Protection Roof



Alu-Rail	Description	Instruction	Billing condition	Type
	33.50.11 Connector			
	<ul style="list-style-type: none"> ■ Missing 			
	<ul style="list-style-type: none"> ■ Or damaged due to violence 			
	33.50.12 Guide rail bent			
	<ul style="list-style-type: none"> ■ Roll movable 			
	<ul style="list-style-type: none"> ■ Or roll no longer movable 			

PERI Rental Criteria

LGS Weather Protection Roof



Ledger (105394; 115018; 105390; 105386)	Description	Instruction	Billing condition	Type
---	-------------	-------------	-------------------	------



33.50.13 Junctions bent/dented

- Insertion of vertical pipes still possible
- Or no longer possible

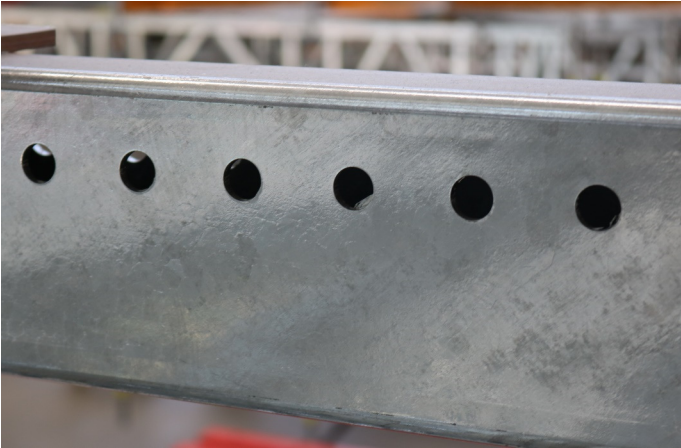

33.50.14 Hole diameter enlarged











- $\varnothing > 18 \text{ mm}$



PERI Rental Criteria

LGS Weather Protection Roof



Rail Support URF (104853)	Description	Instruction	Billing condition	Type
	<p>33.50.15 Junction bent</p> <ul style="list-style-type: none"> ■ If possible (Rails can be inserted) ■ Or if no longer possible 	<ul style="list-style-type: none">   	<ul style="list-style-type: none">   	<ul style="list-style-type: none">  
	<p>33.50.16 Cotter pin missing</p>	<ul style="list-style-type: none">  022230 (Cotter pin) 	<ul style="list-style-type: none">  	<ul style="list-style-type: none"> 

PERI Rental Criteria

LGS Weather Protection Roof



Stopper URA-2 (118022)	Description	Instruction	Billing condition	Type
------------------------	-------------	-------------	-------------------	------

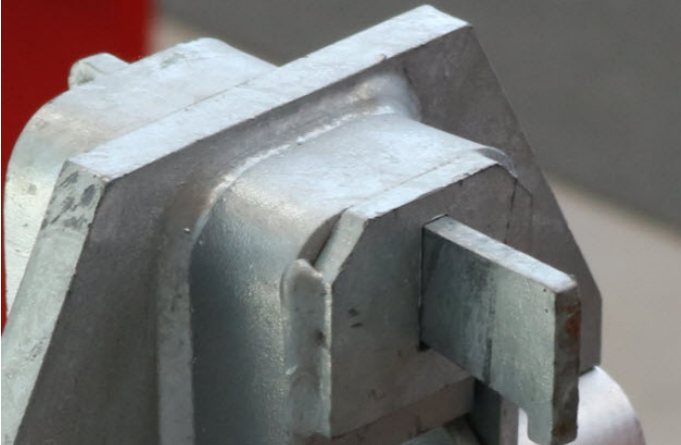

33.50.17 Bracket missing

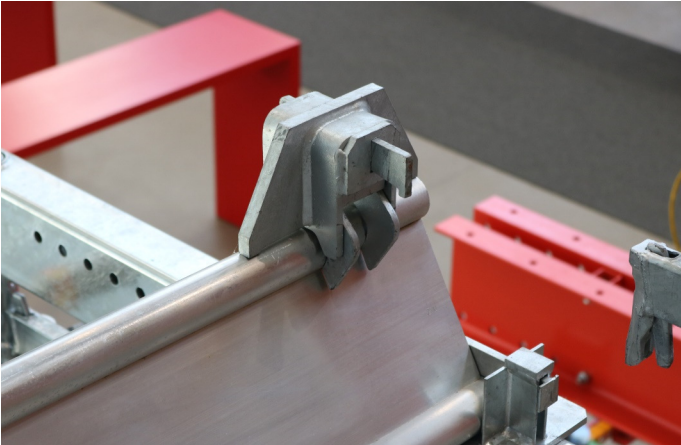

33.50.18 Parts bent

- If possible



Afterwards check the functionality























- Or ff no longer possible



PERI Rental Criteria

LGS Weather Protection Roof



Rail End Element URD (104852)	Description	Instruction	Billing condition	Type
	33.50.19 Plate bent			
	<ul style="list-style-type: none"> ■ If possible 			
	<ul style="list-style-type: none"> ■ Or if no longer possible 			
<ul style="list-style-type: none"> ■ Or cracks in welding 				
	33.50.20 Tubes bent dented			
	<ul style="list-style-type: none"> ■ If possible (Insertion of tubes possible) 			
	<ul style="list-style-type: none"> ■ Or if no longer possible 			
<ul style="list-style-type: none"> ■ Or cracks in zinc layer 				

PERI Rental Criteria

LGS Weather Protection Roof



LGS Bearer URS (105398)	Description	Instruction	Biling condition	Type
-------------------------	-------------	-------------	------------------	------



33.50.21 Bolt/Cotter pin

- Missing



106191 (Bolt 24)
 106194 (Bolt 16)
 022230 (Cotter pin 5/1)
 018060 (Cotter pin 4/1)



- Or no longer usable due to violence



106191 (Bolt 24)
 106194 (Bolt 16)
 022230 (Cotter pin 5/1)
 018060 (Cotter pin 4/1)

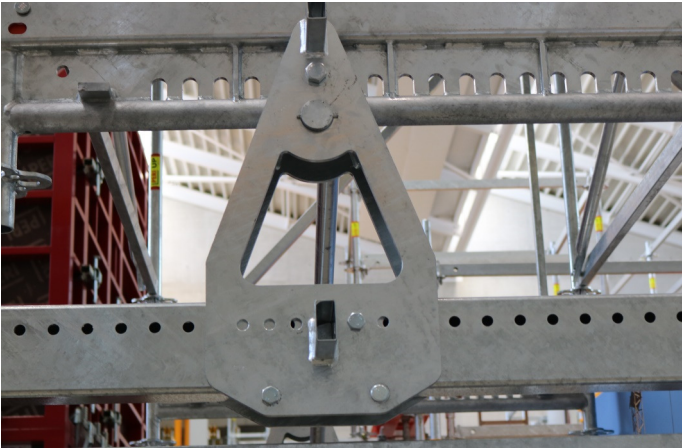

33.50.22 Bent/Dented

- If possible















- Or if no longer possible



PERI Rental Criteria

LGS Weather Protection Roof



Support Roller UEW (104854)	Description	Instruction	Billing condition	Type
	33.50.23 Roller guide dented <ul style="list-style-type: none"> ■ If possible (Roller movable) ■ Or if no longer possible 	 	 	 
	33.50.24 Roller <ul style="list-style-type: none"> ■ Worn ■ Damaged due to violence (functionality disturbed) 	 057164  057164	 	 

PERI Rental Criteria

LGS Weather Protection Roof



LGS Kederrail Ridge Rail Eave Rail	Nr.	Description	Item number
--	-----	-------------	-------------

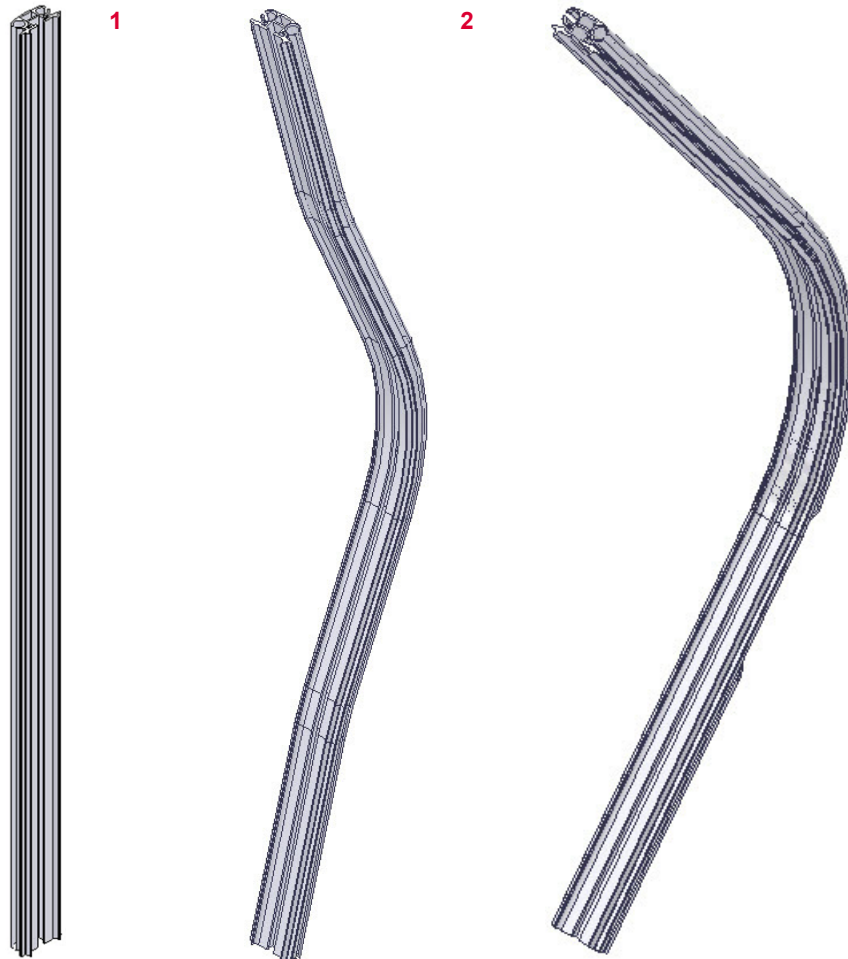

1	Kederrail	
2	Ridge Rail	
3	Eave Rail	

Valid for	
LGS Kederrail URK 150	127501
LGS Kederrail URK 300	127500
LGS Kederrail URK 600	126071
LGS Ridge Rail URK 150	126051
LGS Eave Rail URK	126491

PERI Rental Criteria

LGS Weather Protection Roof



LGS Kederrail Ridge Rail Eave Rail	Description	Instruction	Billing condition	Type
--	-------------	-------------	-------------------	------



33.50.25 Rail completely bent

- Inserting of Keder sheeting possible
- Or inserting of Keder sheeting no longer possible



33.50.26 Guide profile bent | dent

- Inserting of Keder sheeting possible
- Or inserting of Keder sheeting no longer possible



PERI Rental Criteria

LGS Weather Protection Roof



LGS Keder Connector URK (125166)	Description	Instruction	Billing condition	Type
----------------------------------	-------------	-------------	-------------------	------



33.50.27 Claw bent

- If clamping of rail possible
- Or if no longer possible



125165 (Claw with nut)
125162 (Claw without nut)



33.50.28 Screw

- Missing
- Or damaged due to violence



126001 (Bolt)
126001 (Bolt)



PERI Rental Criteria

LGS Weather Protection Roof



LGS Keder Connector URV (126009)	Description	Instruction	Billing condition	Type
----------------------------------	-------------	-------------	-------------------	------

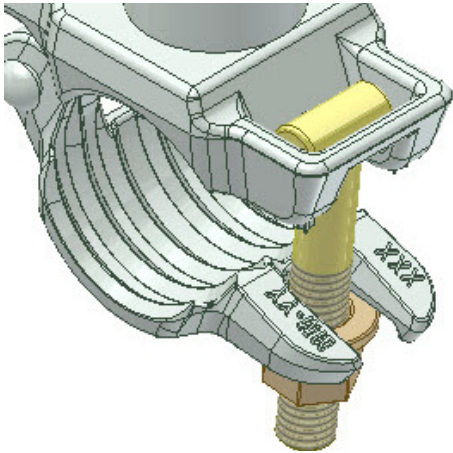

33.50.29 Hammer head bolt | Nut

- Missing
- Or damaged due to violence



131316 (Hammer head bolt)
710330 (Nut)



131316 (Hammer head bolt)
710330 (Nut)



33.50.30 Rail bent

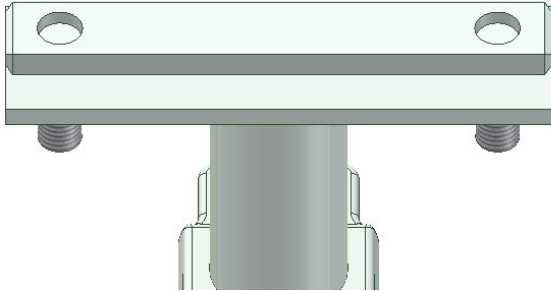

PERI Rental Criteria

LGS Weather Protection Roof



LGS Tarpauling Reel (126484; 126485)	Description	Instruction	Billing condition	Type
--------------------------------------	-------------	-------------	-------------------	------

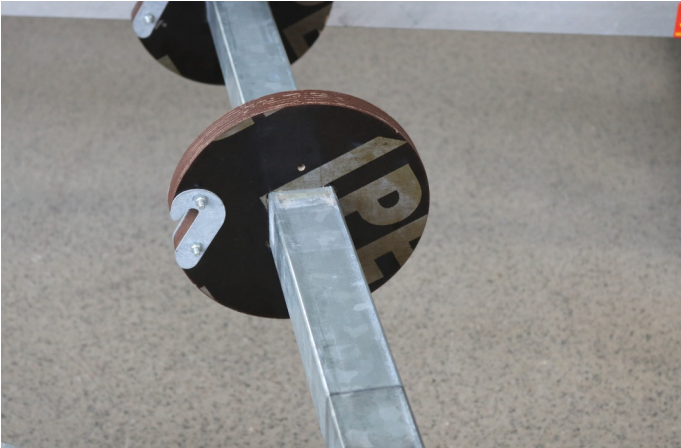

33.50.31 Disc not usable











126949



PERI Rental Criteria

LGS Weather Protection Roof



LGS Reel Connector URG (126486)	Description	Instruction	Billing condition	Type
	<p>33.50.32 Bolt Cotter pin Screw Nut missing</p>	 <p>106031 (Bolt) 018060 (Cotter pin) 126924 (Screw) 710330 (Nut)</p>		
	<p>33.50.33 Junction dented</p>			

PERI Rental Criteria

LGS Weather Protection Roof



LGS Collar URP (105366)	Description	Instruction	Billing condition	Type
-------------------------	-------------	-------------	-------------------	------



33.50.34 Rosetts bent

■ ≤ 20 mm



■ Or > 20 mm



■ Cracks in rosetts

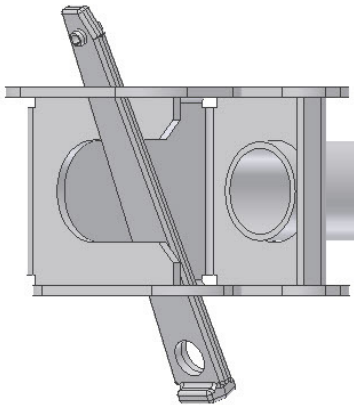

33.50.35 Wedge

■ Missing



024250 (Wedge)
105365 (Dowel pin)



■ No longer movable



















024250 (Wedge)
105365 (Dowel pin)



PERI Rental Criteria

Glossary Icons



Icon	Significance	Icon	Significance	Icon	Significance
	Not Ok– material is scrap		Billing necessary (customer)		Optical damage
	OK– material stays in rental park		No Billing necessary		Functional damage
	Scrap material– it's not permitted to hand out the material because of safety aspects		Shorten the material		Functional damage— it's not permitted to hand out the material
	Repair according to instruction		Mark the material		Static damage— it's not permitted to hand out the material
	Fix material cold– Afterwards check weld seams and bordering components		Replace damaged material		
	Repair after local economic efficiency calculation		Replace missing material		
	Clean the material				