

PERI Rental Criteria

SRS Circular Column Formwork

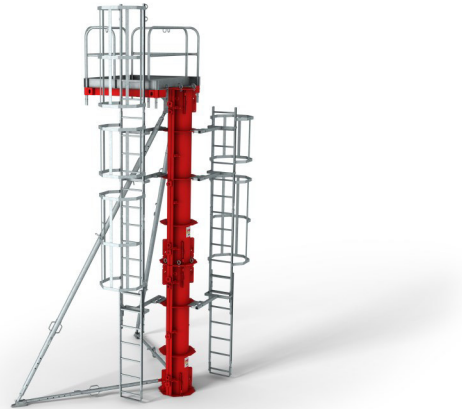

Contact

PERI GmbH
Formwork Scaffolding
Engineering

P. O. Box 1264
 89259 Weißenhorn
 Phone +49 (0) 7309.950-0
 Fax +49 (0) 7309.951-0
rental-criteria@peri.de

Content	Page
Circular column panel	2
Adapter strip	9
Circular column platform	10
Ladder 180/6	13
Ladder connection	14
Ladder safety	15
Glossary	16

Change	Date Initial	Page
New Version	10/2015 fw	

PERI Rental Criteria

SRS Circular Column Formwork



Circular column panel	No.	Description	Article number
-----------------------	-----	-------------	----------------

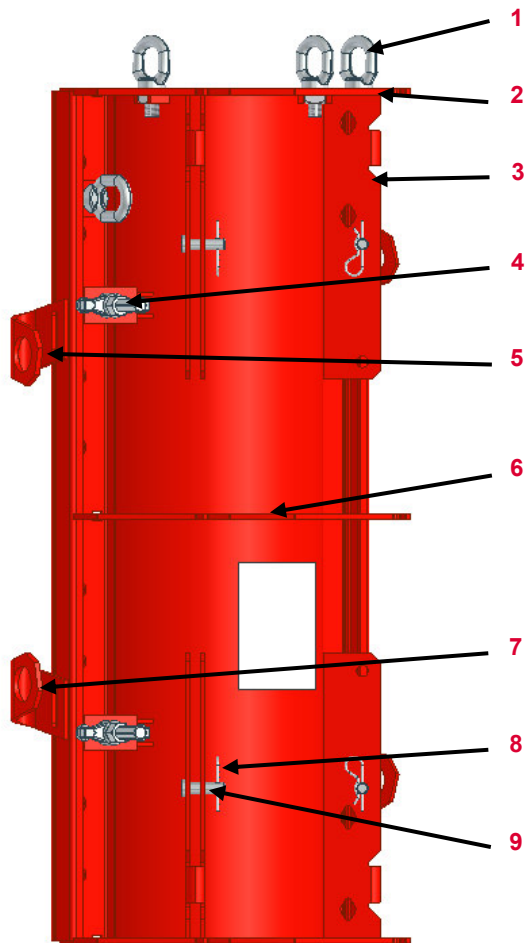

1	Loop bolt	710130
2	Cover plate	
3	Push-pull prop connector	
4	T- Bolt	710038
5	Suspension pipe right	725275
6	Bridge	
7	Suspension pipe left	725278
8	Cotter pin	018060
9	Pin D=16	027170

PERI Rental Criteria

SRS Circular Column Formwork















Article	Article number
Rundsäulenelement Ø 25 cm, h= 0,30 m	045010
Rundsäulenelement Ø 25 cm, h= 1,20 m	045011
Rundsäulenelement Ø 25 cm, h= 2,40 m	045012
Rundsäulenelement Ø 25 cm, h= 3,00 m	045013
Rundsäulenelement Ø 30 cm, h= 0,30 m	045020
Rundsäulenelement Ø 30 cm, h= 1,20 m	045021
Rundsäulenelement Ø 30 cm, h= 2,40 m	045022
Rundsäulenelement Ø 30 cm, h= 3,00 m	045023
Rundsäulenelement Ø 35 cm, h= 0,30 m	045030
Rundsäulenelement Ø 35 cm, h= 1,20 m	045031
Rundsäulenelement Ø 35 cm, h= 2,40 m	045032
Rundsäulenelement Ø 35 cm, h= 3,00 m	045033

Article	Article number
Rundsäulenelement Ø 40 cm, h= 0,30 m	045040
Rundsäulenelement Ø 40 cm, h= 1,20 m	045041
Rundsäulenelement Ø 40 cm, h= 2,40 m	045042
Rundsäulenelement Ø 40 cm, h= 3,00 m	045043
Rundsäulenelement Ø 45 cm, h= 0,30 m	045050
Rundsäulenelement Ø 45 cm, h= 1,20 m	045051
Rundsäulenelement Ø 45 cm, h= 2,40 m	045052
Rundsäulenelement Ø 45 cm, h= 3,00 m	045053
Rundsäulenelement Ø 50 cm, h= 0,30 m	045060
Rundsäulenelement Ø 50 cm, h= 1,20 m	045061
Rundsäulenelement Ø 50 cm, h= 2,40 m	045062
Rundsäulenelement Ø 50 cm, h= 3,00 m	045063

PERI Rental Criteria

SRS Circular Column Formwork











Circular column panel	Description	Instruction	Billing Condition	Type
	23.01 Suspension pipe bent, cut	<ul style="list-style-type: none"> <li data-bbox="875 603 987 635">■ ≤ 6 mm 	 088244	
	<ul style="list-style-type: none"> <li data-bbox="875 751 1021 783">■ Or > 6 mm 		 088592	
	<ul style="list-style-type: none"> <li data-bbox="875 852 976 884">■ Or cut 		 088592	
	23.02 Distance piece broken, cut			

PERI Rental Criteria

SRS Circular Column Formwork











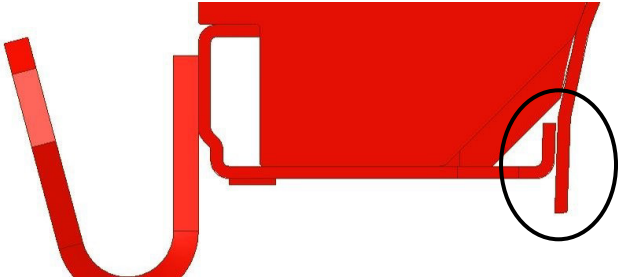





Circular column panel	Description	Instruction	Billing Condition	Type
	<p>23.03 Powder coating in round pillar slightly pillar</p>	<p> Edge of damage grind with sandpaper and spray with forming oil</p>	<p></p>	<p></p>
	<p>23.04 Powder coating badly damaged</p>	<p> Sandblasting and new powder-coated</p>	<p></p>	<p></p>

PERI Rental Criteria

SRS Circular Column Formwork

















Circular column panel	Description	Instruction	Billing Condition	Type
	<p>23.06 Formwork shell supernatant bent</p> <ul style="list-style-type: none"> ■ Without material lost ■ Or with material lost 	 	 088244 	 
	<p>23.07 Cover plate or brigde bent</p> <ul style="list-style-type: none"> ■ > 4 mm 		 088244	
	<p>23.08 Dent in formwork shell</p> <ul style="list-style-type: none"> ■ > 3 mm 		 088244	

PERI Rental Criteria

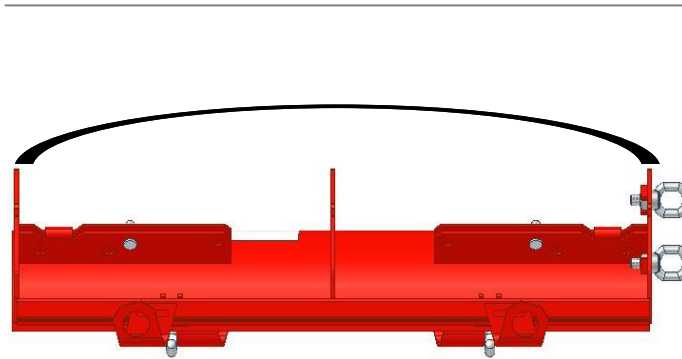
SRS Circular Column Formwork



Circular column panel	Description	Instruction	Billing Condition	Type
	<p>23.08 Holes in formwork shell</p> <ul style="list-style-type: none"> ■ ≤ Ø 10 mm (max. 2 pieces/m) ■ Or > 10 mm ■ Or > 3 pieces./m 	<ul style="list-style-type: none">    	<ul style="list-style-type: none">    	<ul style="list-style-type: none">   
	<p>23.09 Element bent</p> <ul style="list-style-type: none"> ■ > 5 mm 	<ul style="list-style-type: none">   	<ul style="list-style-type: none">  	<ul style="list-style-type: none"> 

PERI Rental Criteria

SRS Circular Column Formwork









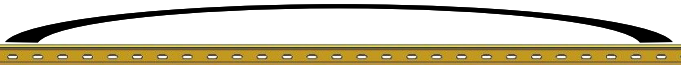

Circular column panel	Description	Instruction	Billing Condition	Type
	<p>23.10 Stacking aid bent</p>		 088244	
	<p>23.11 Push-pull prop connector bent</p>		 088244	

PERI Rental Criteria

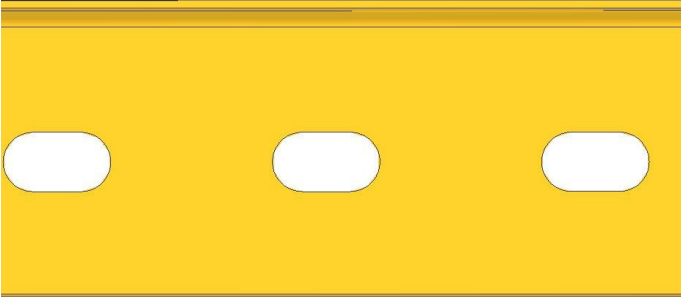
SRS Circular Column Formwork



Adapter strip (045200)	Description	Instruction	Billing Condition	Type
	<p>23.12 Adapter strip bent</p> <ul style="list-style-type: none"> ■ > 5 mm 			
	<p>23.13 Holes rooted up</p>			

PERI Rental Criteria

SRS Circular Column Formwork



Circular column platform 25– 70, (045210)

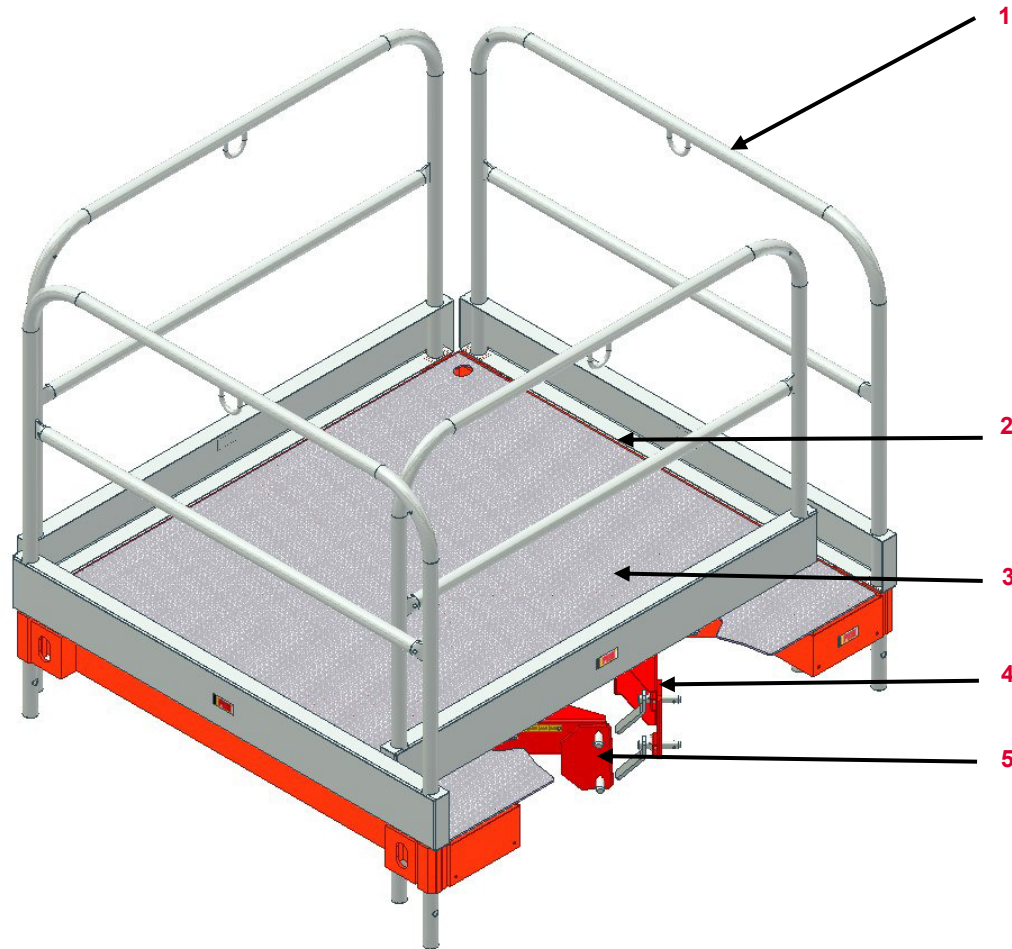



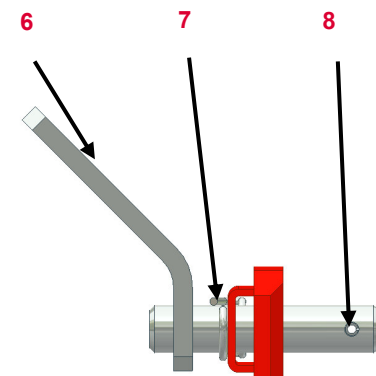







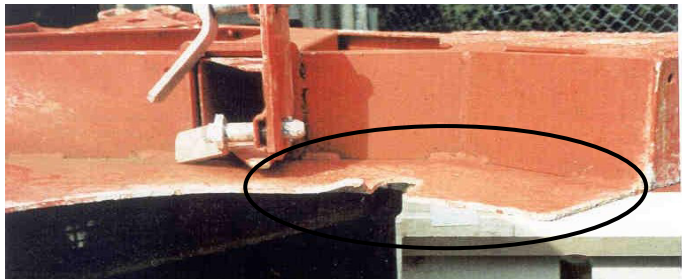

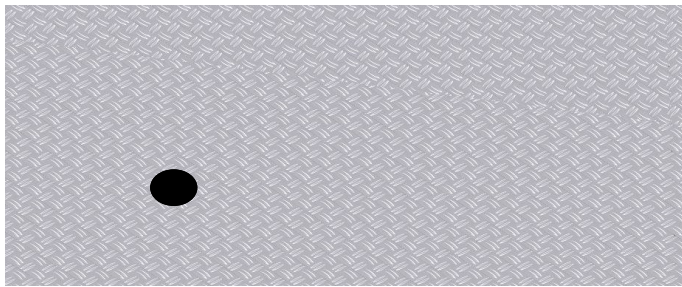

No.	Description	Article number
1	Handrail 134	037430
2	Circular column landing 25– 70	045211
3	Tread plate	
4	Telescopic tube left	785229
5	Telescopic tube right	785227
6	Pin	785232
7	Locking spring	115507
8	Sleeve	710417

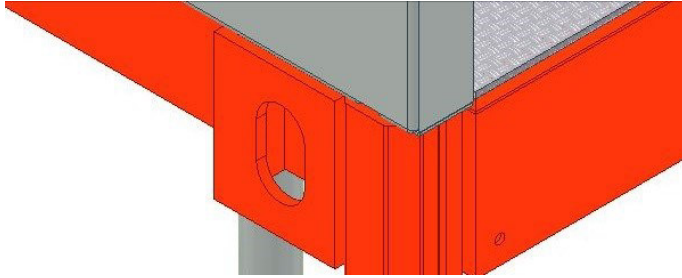

PERI Rental Criteria

SRS Circular Column Formwork





















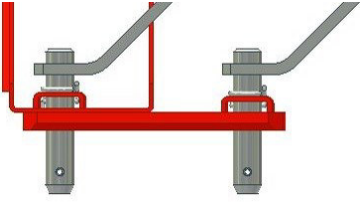



Circular column landing	Description	Instruction	Billing Condition	Type
	<p>23.14 Tread plate bent</p>		 088244	
	<p>23.15 Holes in tread plate</p> <ul style="list-style-type: none"> ■ ≤ 10 mm ■ Or > 10 mm 	<p>   </p>	<p>   </p>	<p>   </p>
	<p>23.16 System for platform handrail bent, rooted up</p>			

PERI Rental Criteria

SRS Circular Column Formwork



Telescopic tube	Description	Instruction	Billing Condition	Type
	23.17 Admission bent	 Telescopic tube left(785229)  Telescopic tube right (785227)	 088595	
	23.18 Holes rooted up	 Telescopic left (785229)  Telescopic right (785227)	 088595	
	23.19 Pins unusable	 Pins(785232)  Sleeve(710417)  Locking spring (115507)	 088789	
	23.20 Tape unreadable, lost	 Tape right (780318)  Tape left (780317)  Rivet (780304)		

PERI Rental Criteria

SRS Circular Column Formwork



Ladder 180/6 (051410)	Description	Instruction	Billing Condition	Type
	<p>23.21 Tread bent</p> <ul style="list-style-type: none"> ■ > 3 mm 			
	<p>23.22 Weld torn</p> <ul style="list-style-type: none"> ■ Without deformation of basic material ■ Or with deformation 			

PERI Rental Criteria

SRS Circular Column Formwork



Ladder connection SRS (103374)	No.	Description	Article number
--------------------------------	-----	-------------	----------------

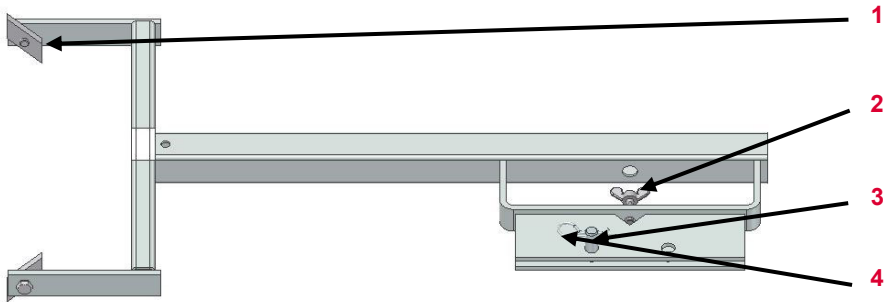

1	Fixing plate	701763
2	Bolt	106955
3	Pin	027171
4	Cotter pin	018060

Damage	Description	Instruction	Billing Condition	Type
--------	-------------	-------------	-------------------	------

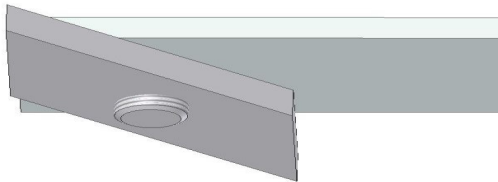

23.23 Fixing plate broken, lost

 Fixing plate (701763)
Bolt (710266)

 088295

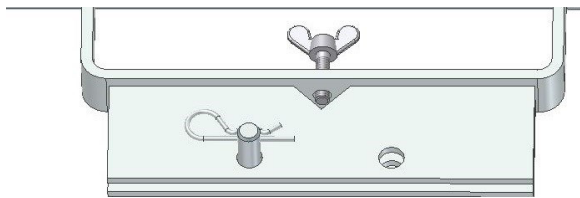

23.24 Bracket, plates bent, unusable



PERI Rental Criteria

SRS Circular Column Formwork



Ladder safety (104132; 051450)	Description	Instruction	Billing Condition	Type
--------------------------------	-------------	-------------	-------------------	------

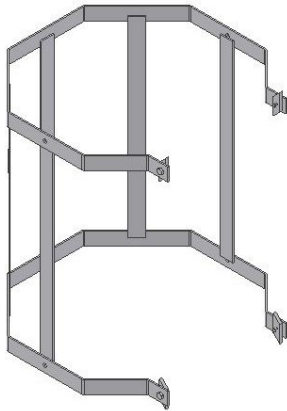

23.25 Bent

■ > 5 mm

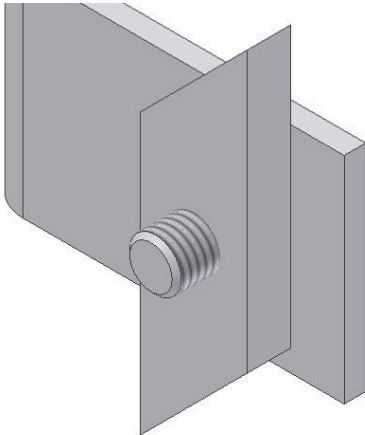

23.26 Fixing plate broken, lost



Fixing plate (701763)
Bolt (710266)



















088295



PERI Rental Criteria

SRS Circular column panel



Icon	Significance	Icon	Significance	Icon	Significance
	Not OK – material is scrap		Billing necessary (customer)		Optical damage
	OK—material stays in rental park		No Billing necessary		Functional damage
	Scrap material—it's not permitted to hand out the material because of safety aspects		Shorten the material		Functional damage –it's not permitted to hand out the material
	Repair according to Instruction		Mark the material		Static damage—it's not permitted to hand out the material
	Fix material cold		Replace damaged material		
	Repair after local economic efficiency calculation		Replace missing material		
	Clean the material				