

# PERI Rental Criteria

## PERI UP Basic Components



### Contact

**PERI GmbH**  
**Formwork Scaffolding**  
**Engineering**  
P.O. Box 1264  
89264 Weissenhorn, Germany  
Phone +49 (0) 7309.950-0  
Fax +49 (0) 7309.951-0  
[rental-criteria@peri.de](mailto:rental-criteria@peri.de)

Content	Page
Steel Deck UDI UDG	2
Access Deck UAL	9
Ledger UH	12
Standards	19
Spindles	23
Diagonals	28
Accessories	37
Access Deck UAA and UAW	49
Couplings	60

Changes made	Date   Initial	Page
New version	02/17   fw	
Access Deck UAA and UAW added	01/19   fw	45
No original profile at UBL added	12/20   fw	26
Flex-2 articles added	06/21   fw	
Couplings added	08/21   fw	60
Changes at Couplings	03/22   fw	60+ 63
Scaffolding Tubes added	03/22   fw	64-65
Wall Tie UWT 70 added	08/22   fw	47

# PERI Rental Criteria

## PERI UP Basic Components



Industrial Deck UDI   UDG   UDG-2	Nr.	Description	Article number
-----------------------------------	-----	-------------	----------------

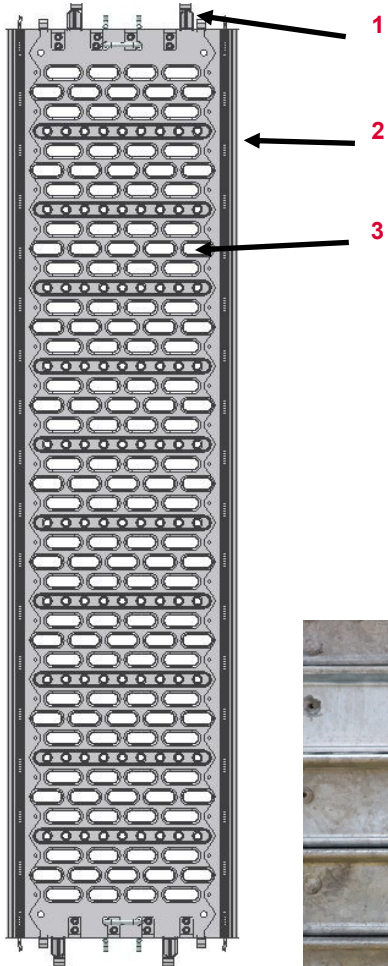

1	Hinge	
2	Side-profile	
3	Decking	

Side profile UDG with holes



Side profile UDI without holes



# PERI Rental Criteria

## PERI UP Basic Components



Article	Article number
UDI 37,5x50	111685
UDI 37,5x75	111687
UDI 37,5x100	111686
UDI 37,5x125	111860
UDI 37,5x150	111863
UDI 37,5x200	111864
UDI 37,5x250	111865
UDI 37,5x300	111969
UDI 25x50	104029
UDI 25x75	105925
UDI 25x100	106092
UDI 25x125	106880
UDI 25x150	107002

Article	Article number
UDI 25x200	108380
UDI 25x250	108540
UDI 25x300	108689
Steel Deck UDG 25 x 50	124124
Steel Deck UDG 25 x 75	124121
Steel Deck UDG 25 x 100	124118
Steel Deck UDG 25 x 125	124115
Steel Deck UDG 25 x 150	124112
Steel Deck UDG 25 x 200	124109
Steel Deck UDG 25 x 250	123771
Steel Deck UDG 25 x 300	124915

# PERI Rental Criteria

## PERI UP Basic Components



Article	Article number
Steel Deck UDG-2 25 x 50	132479
Steel Deck UDG-2 25 x 67	132483
Steel Deck UDG-2 25 x 75	132488
Steel Deck UDG-2 25 x 100	132492
Steel Deck UDG-2 25 x 125	132502
Steel Deck UDG-2 25 x 150	132505
Steel Deck UDG-2 25 x 200	132508
Steel Deck UDG-2 25 x 250	132511
Steel Deck UDG-2 25 x 300	132515



# PERI Rental Criteria

## PERI UP Basic Components



UDI   UDG	Description	Instruction	Billing Condition	Type
-----------	-------------	-------------	-------------------	------

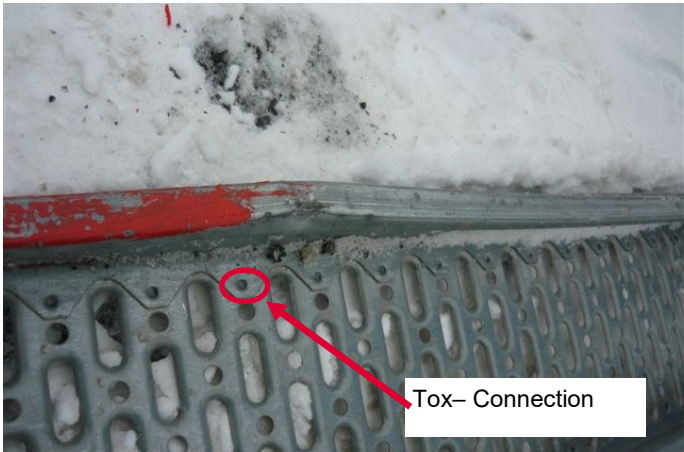

### Side profile bent

- Inserting of Deck possible and Tox- Connection not damaged
- Or inserting not possible
- Or Tox- Connection damaged



### Deck bent

- > l/100
- Or > 15 mm

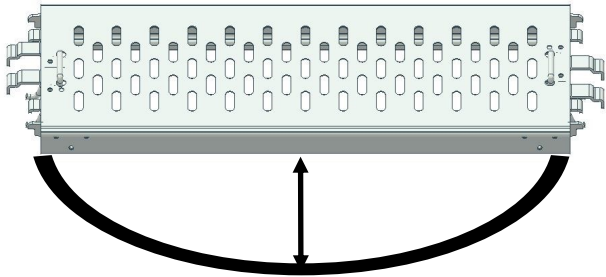

Length	Perm. bent
50	5,0 mm
75	7,5 mm
100	10 mm
125	12,5 mm
150; 200; 250; 300	15,0 mm

# PERI Rental Criteria

## PERI UP Basic Components



UDI   UDG	Description	Instruction	Billing Condition	Type
-----------	-------------	-------------	-------------------	------



Cuts in profile

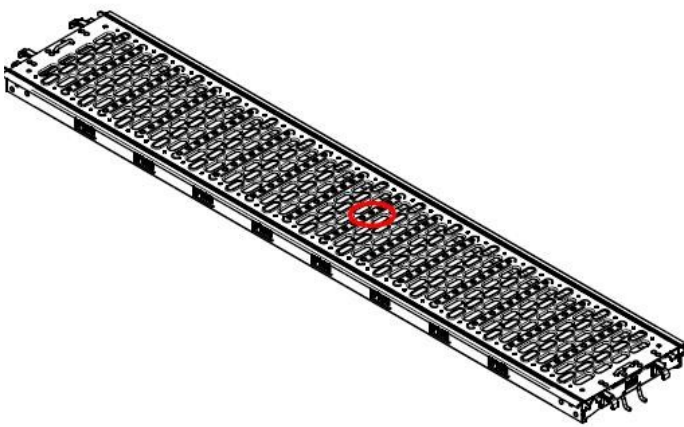

Hole in deck





















■ > Ø 25 mm



# PERI Rental Criteria

## PERI UP Basic Components







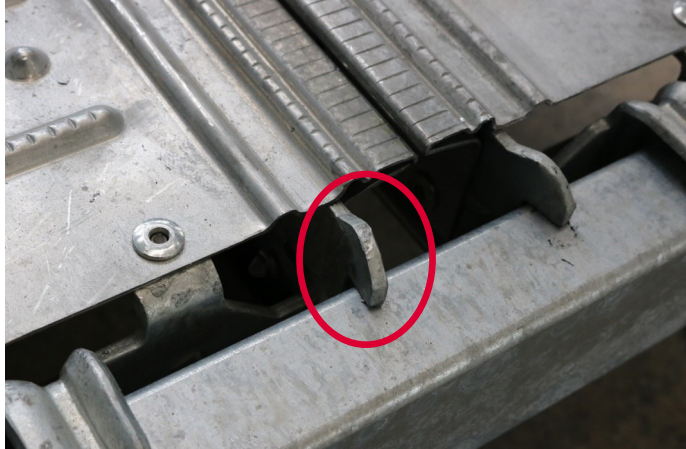

UDI   UDG	Description	Instruction	Billing Condition	Type
	<p><b>Crack in the claw of hinge</b></p> <ul style="list-style-type: none"> <li>■ UDI and UDG riveted</li> <li>■ Or UDG welded</li> </ul>	<ul style="list-style-type: none"> <li>  108714 (Hinge 25) 111482 (Hinge 37,5) UDI 37,5         </li> <li>   </li> </ul>	<ul style="list-style-type: none"> <li>  089007         </li> <li>  </li> </ul>	<ul style="list-style-type: none"> <li>  </li> <li>  </li> </ul>
	<p><b>Claw of hinge bent</b></p> <ul style="list-style-type: none"> <li>■ Without cracks in claw and bent <math>\leq 5</math> mm</li> <li>■ Or bent <math>&gt; 5</math> mm and UDI or UDG riveted</li> <li>■ Or bent <math>&gt; 5</math> mm and UDG welded</li> </ul>	<ul style="list-style-type: none"> <li>   </li> <li>  108714 (Hinge 25) 111482 (Hinge 37,5) UDI 37,5         </li> <li>   </li> </ul>	<ul style="list-style-type: none"> <li>  </li> <li>  </li> <li>  </li> </ul>	<ul style="list-style-type: none"> <li>  </li> <li>  </li> <li>  </li> </ul>

# PERI Rental Criteria

## PERI UP Basic Components



UDI   UDG	Description	Instruction	Billing Condition	Type
	<p><b>Hook at Hinge bent</b></p> <ul style="list-style-type: none"> <li>■ Without cracks in material</li> <li>■ Or with cracks in material</li> </ul>	<ul style="list-style-type: none"> <li></li> <li></li> </ul>	<ul style="list-style-type: none"> <li></li> <li></li> </ul>	<ul style="list-style-type: none"> <li></li> <li></li> </ul>

# PERI Rental Criteria

## PERI UP Basic Components



Access Deck UAL-3	Nr.	Description	Article number
-------------------	-----	-------------	----------------

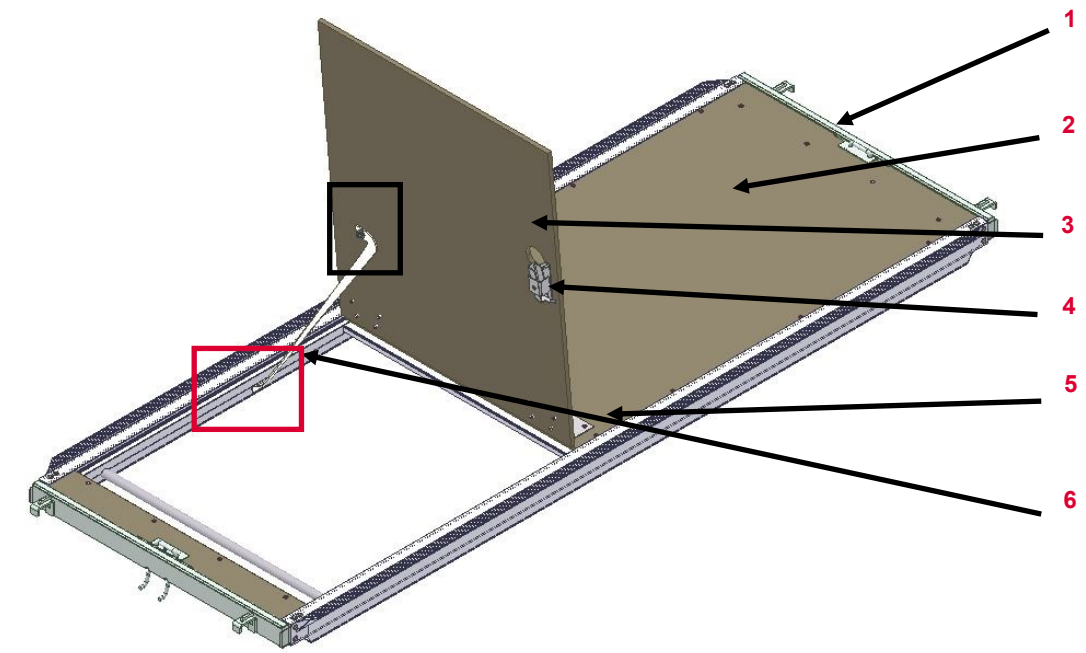

1	Hinge UAL	128329
2	Plywood Decking	
3	Access Deck UAL 75	126303
4	Latch UAL	115566
5	Hinge	128319
6	Plastic Rope	127472
7	Bolt M 6 x 25	127348
8	Disc	127036
9	Nut M 6	129396
10	Rivet	127334

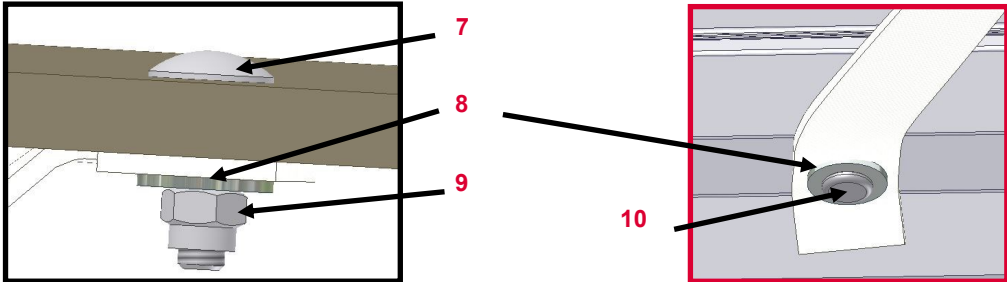









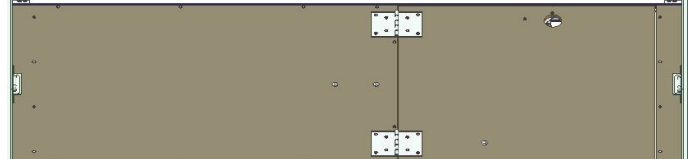

Valid for	Item number
Access Deck UAL-3 75x150/3	126393
Access Deck UAL-3 75x200/3	126392
Access Deck UAL-3 75x250/3	126314

# PERI Rental Criteria

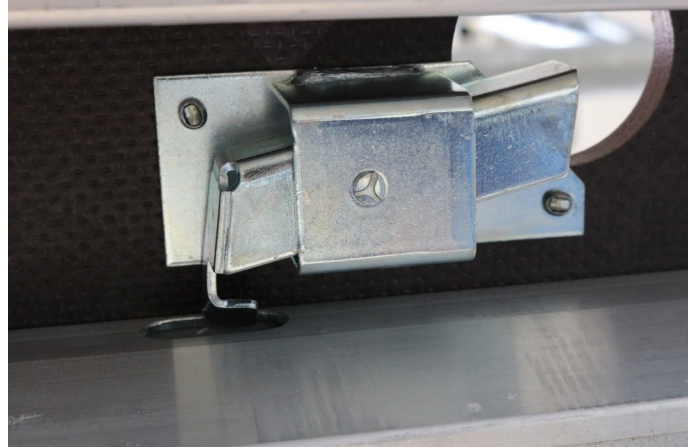
## PERI UP Basic Components















Access Deck	Description	Instruction	Billing Condition	Type
	<p><b>Decking</b></p>	<ul style="list-style-type: none"> <li>■ Worn</li> </ul> 		
	<ul style="list-style-type: none"> <li>■ Or unusable through force</li> </ul>			
	<p><b>Latch damaged</b></p>			

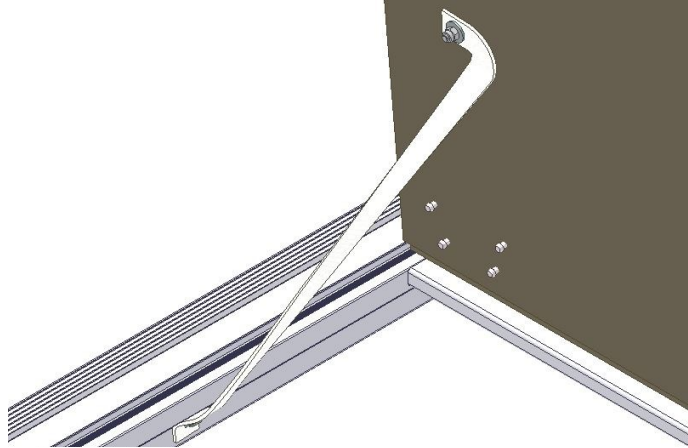

# PERI Rental Criteria

## PERI UP Basic Components



Access Deck	Description	Instruction	Billing Condition	Type
	<b>Hinge</b>			
	<ul style="list-style-type: none"> <li>■ Cracks in claws</li> </ul>			
	<ul style="list-style-type: none"> <li>■ Or function of lifting protection disturbed</li> </ul>			
	<b>Rope</b>			
	<ul style="list-style-type: none"> <li>■ Cut off</li> </ul>			
	<ul style="list-style-type: none"> <li>■ Or missing</li> </ul>			

# PERI Rental Criteria

## PERI UP Basic Components



Ledger UH and UH Plus	Nr.	Description	Article number
-----------------------	-----	-------------	----------------

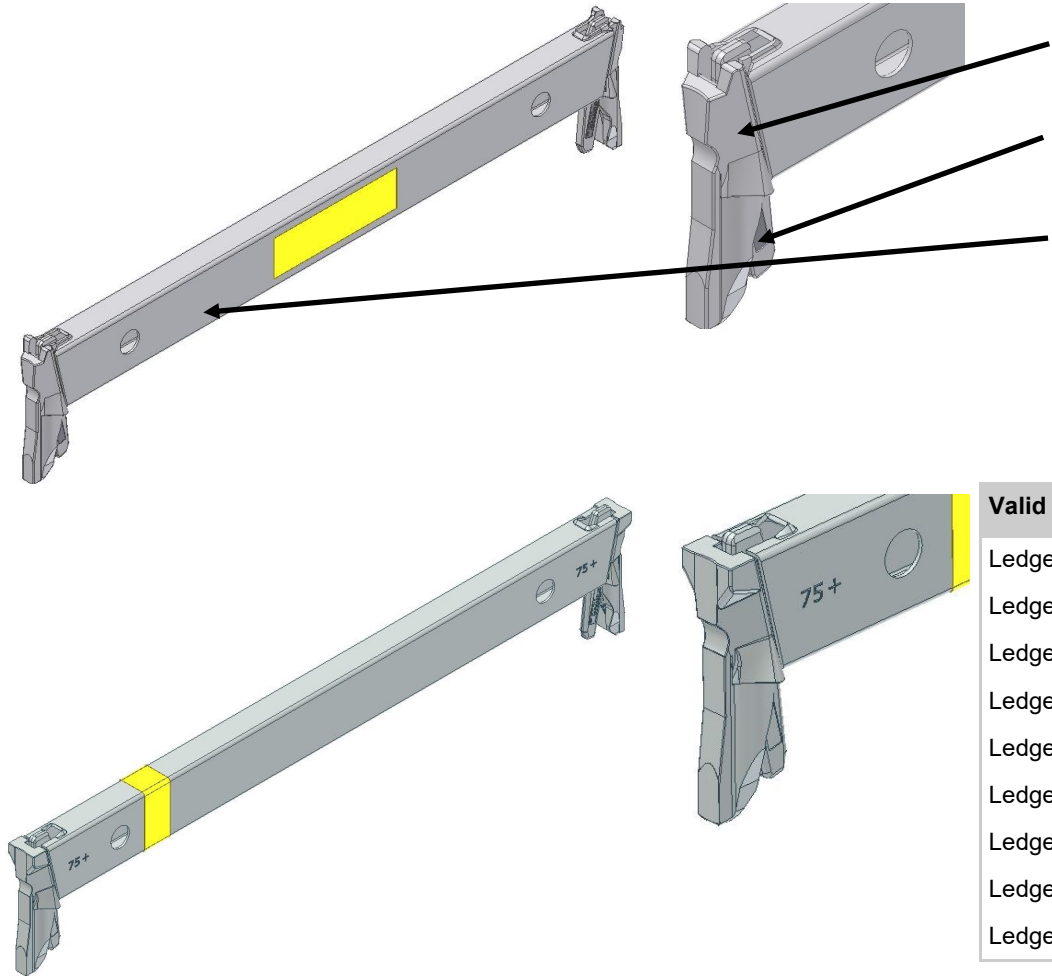

- |   |   |            |
|---|---|------------|
| 1 | 1 | Wedge-head |
| 2 | 2 | Wedge      |
| 3 | 3 | Tube       |

Valid for	Item Number
Ledger UH 72	100440
Ledger UH 104	100192
Ledger UH 150	100021
Ledger UH 200	100023
Ledger UH 250	100025
Ledger UH 300	100027
Ledger UH 400	100029
Ledger UH 75	100017
Ledger UH 100	101159

Valid for	Item Number
Ledger UH 25 Plus	114613
Ledger UH 37,5 Plus	125840
Ledger UH 50 Plus	114595
Ledger UH 67 Plus	129982
Ledger UH 72 Plus	114124
Ledger UH 75 Plus	114629
Ledger UH 100 Plus	114632
Ledger UH 104 Plus	114635
Ledger UH 125 Plus	114638
Ledger UH 150 Plus	114641
Ledger UH 175 Plus	117032
Ledger UH 200 Plus	114645
Ledger UH 225 Plus	116356
Ledger UH 250 Plus	114648
Ledger UH 300 Plus	114651
Ledger UH 400 Plus	114654



# PERI Rental Criteria

## PERI UP Basic Components



Ledger UH-2   UHV-2	Nr.	Description	Article number
---------------------	-----	-------------	----------------

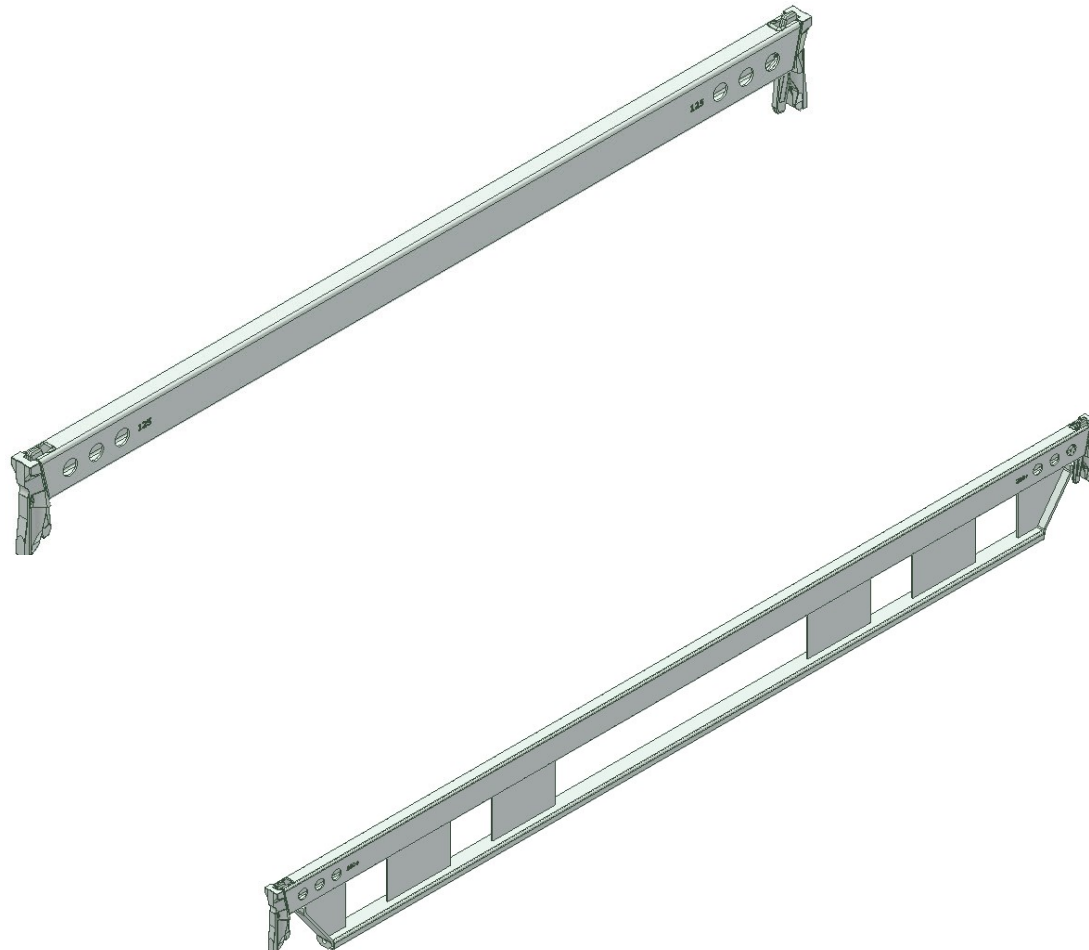

Valid for	Item Number
Ledger UH-2 25	131995
Ledger UH-2 33	133900
Ledger UH-2 50	131998
Ledger UH-2 67	133903
Ledger UH-2 75	132213
Ledger UH-2 100	132004
Ledger UH-2 125	132007
Ledger UH-2 150	132010
Ledger UH-2 175	132013
Ledger UH-2 200	132016
Ledger UH-2 225	132019
Ledger UH-2 250	132025
Ledger UH-2 300	132022
Ledger UHV-2 150	137020
Ledger UHV-2 200	137025
Ledger UHV-2 250	137030
Ledger UHV-2 300	137035

# PERI Rental Criteria

## PERI UP Basic Components



UH Ledger	Description	Instruction	Billing Condition	Type
-----------	-------------	-------------	-------------------	------



**Local dent in profile**

- Edges not affected



















**Wedge-opening torn out | Wedge missing**



# PERI Rental Criteria

## PERI UP Basic Components

















UH Ledger	Description	Instruction	Billing Condition	Type
	<p><b>Profile bent</b></p>			
	<p><b>Dent at the end</b></p> <ul style="list-style-type: none"> <li>■ If edges not affected and no crack in material and function of wedge given</li> <li>■ Or if edges affected</li> <li>■ Or crack in material</li> <li>■ Or function of wedge not given</li> </ul>	<ul style="list-style-type: none"> <li></li> <li></li> <li></li> <li></li> </ul>	<ul style="list-style-type: none"> <li></li> <li></li> <li></li> <li></li> </ul>	<ul style="list-style-type: none"> <li></li> <li></li> <li></li> <li></li> </ul>

# PERI Rental Criteria

## PERI UP Basic Components



UH Ledger	Description	Instruction	Billing Condition	Type
	<p><b>Hole dented</b></p> <ul style="list-style-type: none"> <li>■ If original geometry preserved</li> <li>■ Or if changed</li> <li>■ Or cracks in material</li> </ul>	<ul style="list-style-type: none"> <li></li> <li></li> <li></li> </ul>	<p> 088244</p> <p></p> <p></p>	<ul style="list-style-type: none"> <li></li> <li></li> <li></li> </ul>
	<p><b>Profile bent in vertical axis</b></p>	<ul style="list-style-type: none"> <li></li> </ul>	<p></p>	<ul style="list-style-type: none"> <li></li> </ul>

# PERI Rental Criteria

## PERI UP Basic Components



UH- Ledger	Description	Instruction	Billing Condition	Type
------------	-------------	-------------	-------------------	------



**Profile bent in vertical axis**

- No damage to edges and  $\leq$  allowed bending ( $l/300$ )



Component	Perm. bending
Ledger UH 25	3 mm
Ledger UH 50	3 mm
Ledger UH 75	3 mm
Ledger UH 100	3 mm
Ledger UH 125	4 mm
Ledger UH 150	5 mm
Ledger UH 200	7 mm
Ledger UH 250	8 mm
Ledger UH 300	10 mm

- Or  $>$  allowed bending











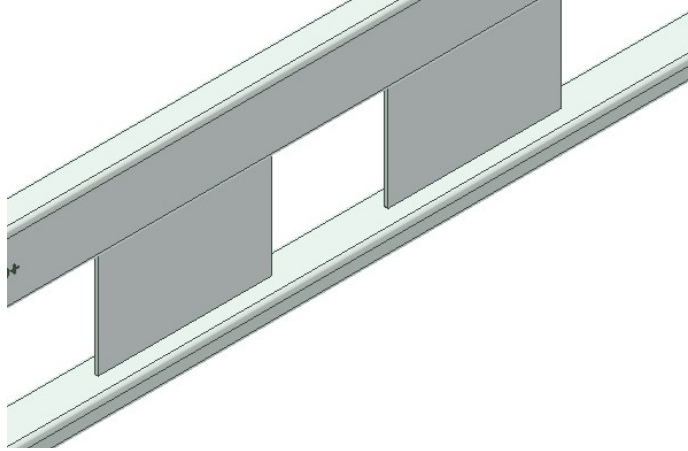



# PERI Rental Criteria

## PERI UP Basic Components



UHV-2 Ledger	Description	Instruction	Billing Condition	Type
	<p><b>Plaids bent</b></p> <ul style="list-style-type: none"> <li>■ If possible</li> <li>■ Or if not possible</li> </ul>	<p>If possible: </p> <p>Or if not possible: </p>	<p>If possible: </p> <p>Or if not possible: </p>	<p>If possible: </p> <p>Or if not possible: </p>
	<p><b>Profile bent in vertical axis</b></p>	<p></p>	<p></p>	<p></p>

# PERI Rental Criteria

## PERI UP Basic Components



Base Standard UVB   Standard UVR   Top Standard UVH	Nr.	Description	Article number
---	-----	-------------	----------------



- 1 Junction
- 2 Rosett
- 3 Spigot

Valid for	Article number
Base Standard UVB 24	100014
Base Standard UVB 49	117194
Standard UVR 50	102859
Standard UVR 100	101306
Standard UVR 150	102860
Standard UVR 200	100009
Standard UVR 300	100012
Standard UVR 400	100013
Top Standard UVH 50	101309
Top Standard UVH 100	100000
Top Standard UVH 125	117195
Top Standard UVH 150	100003
Top Standard UVH 200	100005
Top Standard UVH 250	100007

# PERI Rental Criteria

## PERI UP Basic Components



Top Standard UVH-2	Nr.	Description	Article number
--------------------	-----	-------------	----------------

















Valid for	Item Number
Top Standard UVH-2 50	132123
Top Standard UVH-2 100	132194
Top Standard UVH-2 125	132196
Top Standard UVH-2 150	132198
Top Standard UVH-2 200	132200
Top Standard UVH-2 250	132202



# PERI Rental Criteria

## PERI UP Basic Components



Standards	Description	Instruction	Billing Condition	Type
	<p><b>Rosett bent</b></p> <ul style="list-style-type: none"> <li>■ ≤ 20 mm</li> <li>■ Or &gt; 20 mm</li> <li>■ Or cracks in rosett</li> </ul>	<ul style="list-style-type: none"> <li>  </li> <li>  </li> <li>  </li> </ul>	<ul style="list-style-type: none"> <li>  </li> <li>  </li> <li>  </li> </ul>	<ul style="list-style-type: none"> <li>  </li> <li>  </li> <li>  </li> </ul>
	<p><b>Massive Soiling</b></p>	<ul style="list-style-type: none"> <li>  </li> </ul>	<ul style="list-style-type: none"> <li>  </li> </ul>	<ul style="list-style-type: none"> <li>  </li> </ul>

# PERI Rental Criteria

## PERI UP Basic Components



Standard	Description	Instruction	Billing Condition	Type
----------	-------------	-------------	-------------------	------



**UVR bent**

- > permitted bending (L/500)



Component	Perm. bending
UVR 50	5 mm
UVR 100	5 mm
UVR 150	5 mm
UVR 200	5 mm
UVR 300	6 mm
UVR 400	8 mm



**Junction or Spigot bent**

- Assembling impossible
- Or cracks in material



# PERI Rental Criteria

## PERI UP Basic Components



Adj. Base Plate UJB   Adj Base Plate UJS Swivel   Section Spindle UJK	Nr.	Description	Article number
---	-----	-------------	----------------

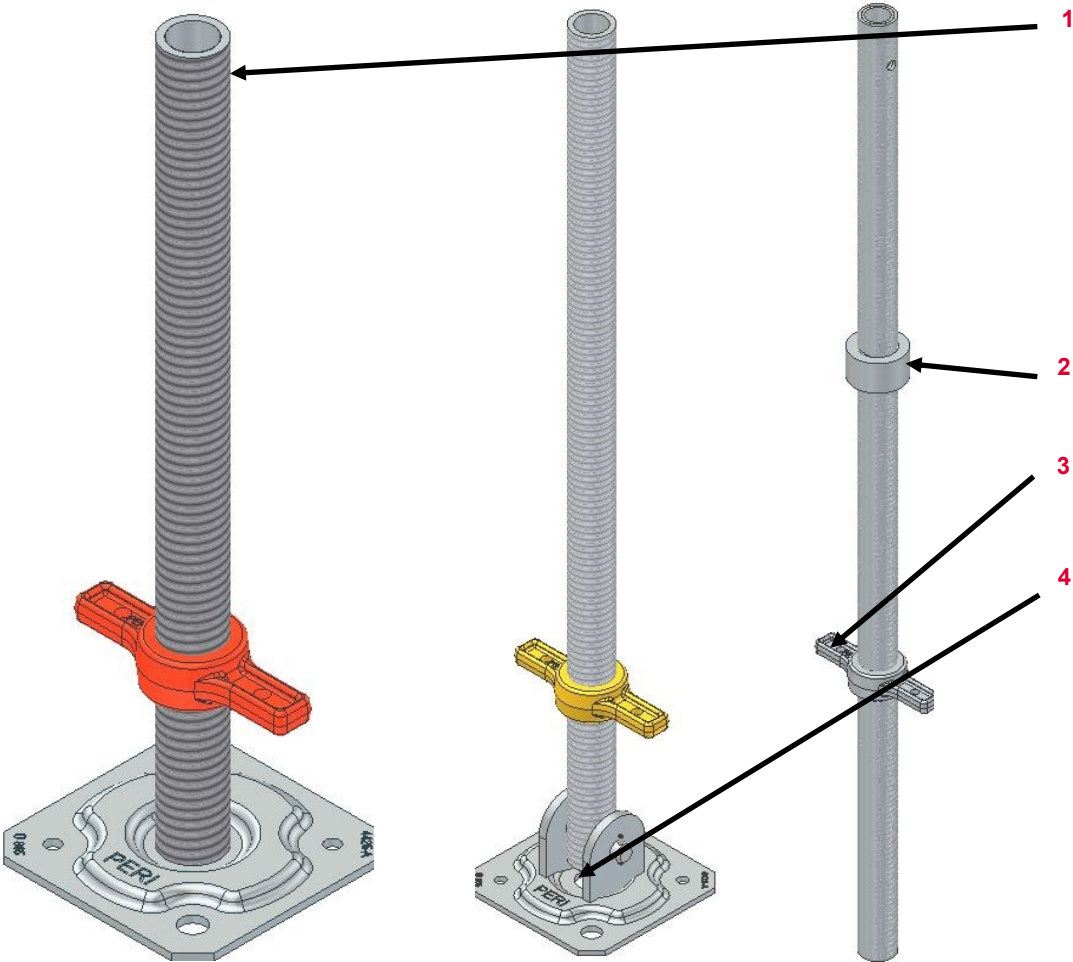











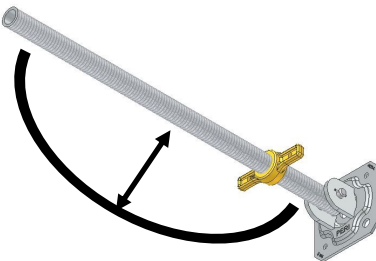



1	Spindle	
2	Weld nut	
3	Cam nut 38	710071
4	Base Plate	

Gültig für	Artikelnummer
Adj Base Plate UJB 38-36/17	116762
Adj Base Plate UJB 38-36/30	100411
Adj Base Plate UJB 38-36/55	100242
Adj Base Plate UJS 38-80 /50 Swivel	100159
Section Spindle UJK 38-110/41	111072

# PERI Rental Criteria

## PERI UP Basic Components

















Spindles	Description	Instruction	Billing Condition	Type
	<p><b>Spindles bent</b></p>			
	<p><b>Cam nut broken</b></p>			
	<p><b>Base Plate bent</b></p> <ul style="list-style-type: none"> <li>■ If possible</li> <li>■ Or If not possible</li> <li>■ Or Weld cracked</li> </ul>	<p>     </p>	<p>  088244   </p>	<p>    </p>

# PERI Rental Criteria

## PERI UP Basic Components











Base Plate UJP (100244)	Description	Instruction	Billing Condition	Type
	<p><b>Base plate bent</b></p> <ul style="list-style-type: none"> <li>■ If possible</li> <li>■ Or if not possible</li> <li>■ Or weld cracked</li> </ul>	<ul style="list-style-type: none"> <li></li> <li></li> <li></li> </ul>	<ul style="list-style-type: none"> <li></li> <li></li> <li></li> </ul>	<ul style="list-style-type: none"> <li></li> <li></li> <li></li> </ul>
	<p><b>Pipe bent</b></p>	<ul style="list-style-type: none"> <li></li> </ul>	<ul style="list-style-type: none"> <li></li> </ul>	<ul style="list-style-type: none"> <li></li> </ul>

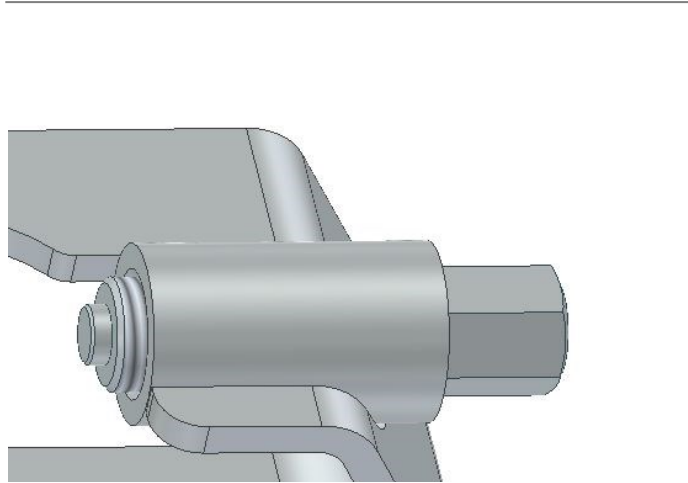

# PERI Rental Criteria

## PERI UP Basic Components













Spindle Locking UJS (100863)	Description	Instruction	Billing Condition	Type
	<p><b>Spindle Locking bent</b></p> <ul style="list-style-type: none"> <li>■ Function not provided</li> </ul>			
	<p><b>Thread not movable</b></p>			

# PERI Rental Criteria

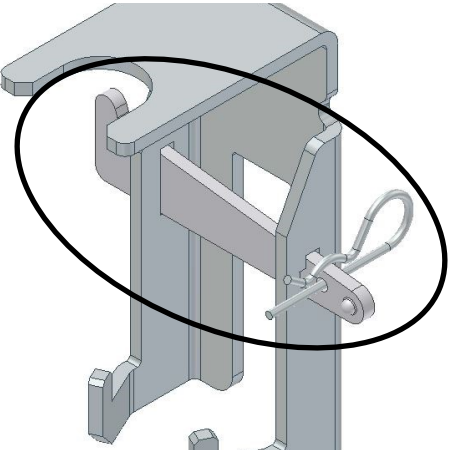
## PERI UP Basic Components



Head Spindle Locking UJH (109563)	Description	Instruction	Billing Condition	Type
	<p><b>Head spindle locking bent</b></p> <ul style="list-style-type: none"> <li>■ If possible</li> <li>■ Or if not possible</li> </ul>	<p>If possible: </p> <p>Or if not possible: </p>	<p>If possible: </p> <p>Or if not possible: </p>	<p></p> <p></p>
	<p><b>Wedge missing/damaged</b></p>	<p></p>	<p></p>	<p></p>

# PERI Rental Criteria

## PERI UP Basic Components



Ledger Braces UBL	Nr.	Description	Article number
-------------------	-----	-------------	----------------



1	Inserting pin	
2	Pipe	
3	Dowel pin or Grooved Pin	710910   131386
4	Profile FL	710123



# PERI Rental Criteria

## PERI UP Basic Components



Item	Article number
Ledger Brace UBL 100/50	115156
Ledger Brace UBL 150/50	107867
Ledger Brace UBL 200/50	104391
Ledger Brace UBL 225/50	130282
Ledger Brace UBL 300/50	104762
Ledger Brace UBL 104/100	106613
Ledger Brace UBL 150/100	100055
Ledger Brace UBL 200/100	100059
Ledger Brace UBL 225/100	130283
Ledger Brace UBL 250/100	100063
Ledger Brace UBL 300/100	100067
Ledger Brace UBL 100/150	115513
Ledger Brace UBL 150/150	102846
Ledger Brace UBL 200/150	102862

Item	Article number
Ledger Brace UBL 250/150	102861
Ledger Brace UBL 300/150	104766
Ledger Brace UBL 100/200	115157
Ledger Brace UBL 150/200	100057
Ledger Brace UBL 175/200	109034
Ledger Brace UBL 200/200	100061
Ledger Brace UBL 225/200	117689
Ledger Brace UBL 250/200	100065
Ledger Brace UBL 300/200	100069

# PERI Rental Criteria

## PERI UP Basic Components













Item	Article number
Ledger Brace UBL-2 100/50	132771
Ledger Brace UBL-2 150/50	132779
Ledger Brace UBL-2 200/50	132789
Ledger Brace UBL-2 225/50	132797
Ledger Brace UBL-2 300/50	132827
Ledger Brace UBL-2 100/100	132773
Ledger Brace UBL-2 150/100	132781
Ledger Brace UBL-2 200/100	132791
Ledger Brace UBL-2 225/100	132808
Ledger Brace UBL-2 250/100	132812
Ledger Brace UBL-2 300/100	132829
Ledger Brace UBL-2 100/150	132775
Ledger Brace UBL-2 150/150	132783
Ledger Brace UBL-2 200/150	132793

Item	Article number
Ledger Brace UBL-2 250/150	132814
Ledger Brace UBL-2 300/150	132831
Ledger Brace UBL-2 100/200	132777
Ledger Brace UBL-2 150/200	132785
Ledger Brace UBL-2 175/200	132787
Ledger Brace UBL-2 200/200	132795
Ledger Brace UBL-2 225/200	132810
Ledger Brace UBL-2 250/200	132816
Ledger Brace UBL-2 300/200	132833

# PERI Rental Criteria

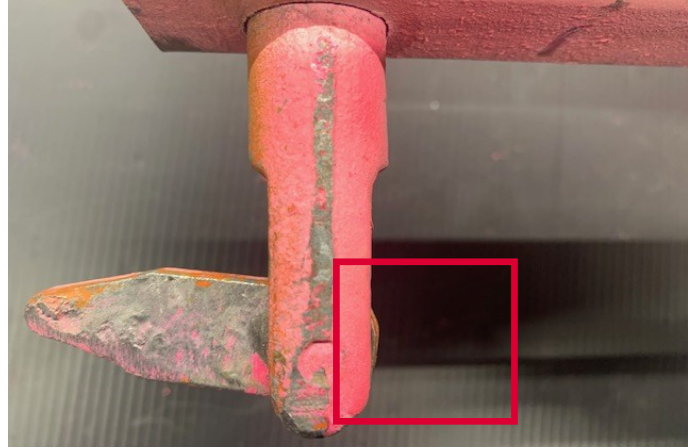
## PERI UP Basic Components



Ledger Brace UBL	Description	Instruction	Billing Condition	Type
	<p><b>Profile</b></p> <ul style="list-style-type: none"> <li>■ Missing</li> <li>■ Or damaged</li> </ul>	<ul style="list-style-type: none"> <li>            710910 (Dowel pin) or            131386 (Grooved pin)            710123 (Profile)         </li> <li>            710910 (Dowel pin)            710123 (Profile)         </li> </ul>	<ul style="list-style-type: none"> <li>  </li> <li>  </li> </ul>	<ul style="list-style-type: none"> <li>  </li> <li>  </li> </ul>
	<p><b>Non original profile according to PSIT—Notice 2020-08-UBL</b></p>	<ul style="list-style-type: none"> <li>            710910 (Dowel pin) or            131386 (Grooved pin)            710123 (Profile)         </li> </ul>	<ul style="list-style-type: none"> <li>  </li> </ul>	<ul style="list-style-type: none"> <li>  </li> </ul>

# PERI Rental Criteria

## PERI UP Basic Components



Ledger Brace UBL	Description	Instruction	Billing Condition	Type
	<p><b>Diagonal bent</b></p> <ul style="list-style-type: none"> <li>■ &gt; 5 mm (l/500)</li> </ul>			
	<p><b>Dents in profile</b></p> <ul style="list-style-type: none"> <li>■ <math>\varnothing &gt; 3 \text{ cm}</math></li> </ul>			

# PERI Rental Criteria

## PERI UP Basic Components



Node Brace UBK   UBK-2	Nr.	Description	Article number
------------------------	-----	-------------	----------------

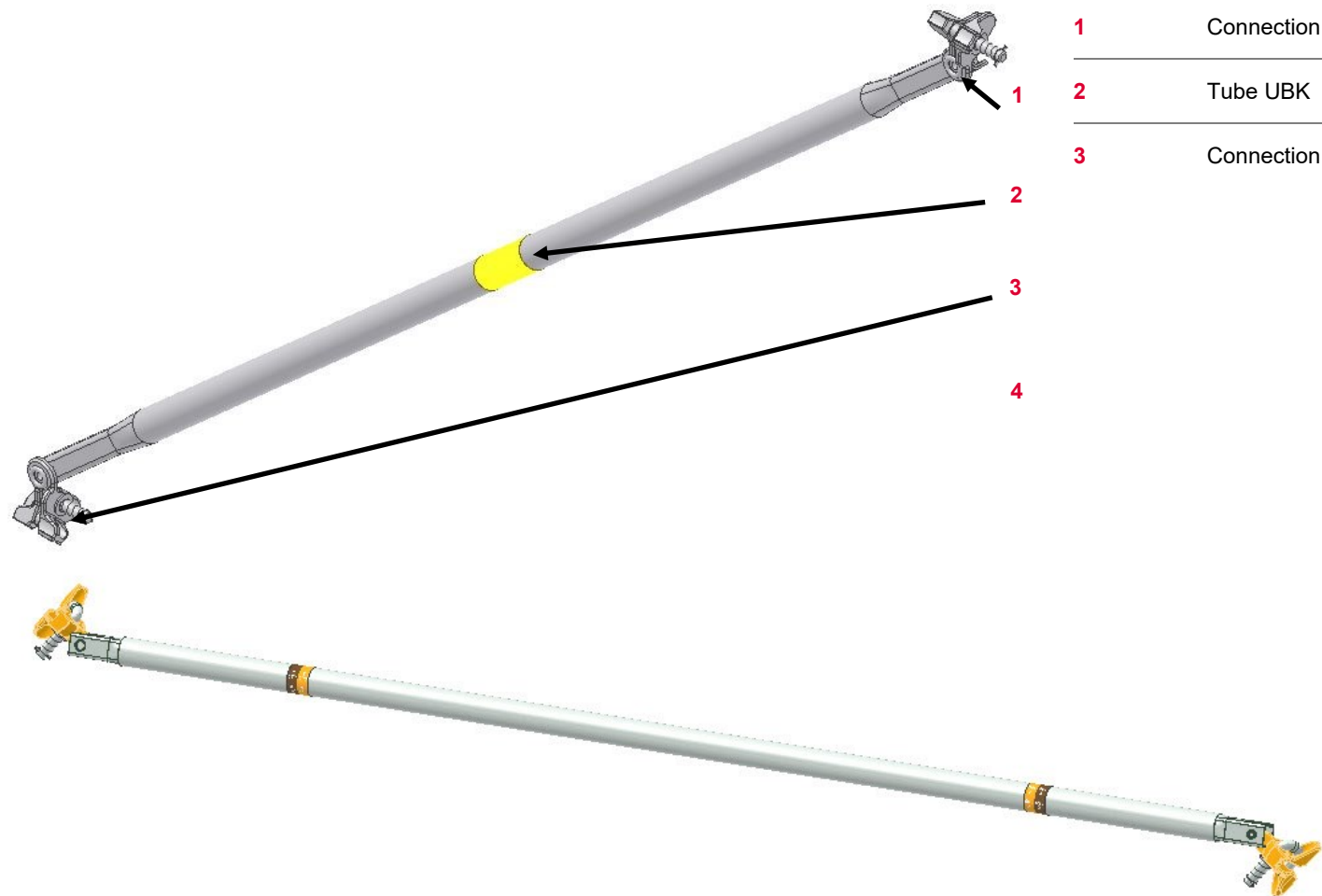

1	Connection UBK right
2	Tube UBK
3	Connection UBK left

# PERI Rental Criteria

## PERI UP Basic Components



Item	Article number
Node Brace UBK 72/100	106969
Node Brace UBK 104/100	100977
Node Brace UBK 125/100	115354
Node Brace UBK 150/100	100981
Node Brace UBK 200/100	100985
Node Brace UBK 250/100	100989
Node Brace UBK 300/100	100993
Node Brace UBK 150/150	100973
Node Brace UBK 200/150	106630
Node Brace UBK 250/150	106624

Item	Article number
Node Brace UBK 72/200	100969
Node Brace UBK 75/200	124170
Node Brace UBK 100/200	112926
Node Brace UBK 104/200	100840
Node Brace UBK 125/200	112765
Node Brace UBK 150/200	100572
Node Brace UBK 200/200	100573
Node Brace UBK 250/200	100574
Node Brace UBK 300/200	100575

# PERI Rental Criteria

## PERI UP Basic Components











Item	Article number
Node Brace UBK-2 125/100	133424
Node Brace UBK-2 150/100	133430
Node Brace UBK-2 200/100	133439
Node Brace UBK-2 250/100	133448
Node Brace UBK-2 300/100	133457
Node Brace UBK-2 150/150	133433
Node Brace UBK-2 200/150	133442
Node Brace UBK-2 250/150	133451
Node Brace UBK-2 300/150	133460

Item	Article number
Node Brace UBK-2 75/200	133418
Node Brace UBK-2 100/200	133421
Node Brace UBK-2 125/200	133427
Node Brace UBK-2 150/200	133436
Node Brace UBK-2 200/200	133445
Node Brace UBK-2 250/200	133454
Node Brace UBK-2 300/200	133463

# PERI Rental Criteria

## PERI UP Basic Components



Node Brace	Description	Instruction	Billing Condition	Type
	<p>Flanging damaged</p>			
	<p>Missing Node-Connection</p>			



# PERI Rental Criteria

## PERI UP Basic Components



Horizontal Brace UBH   UBH Flex	Nr.	Description	Article number
---------------------------------	-----	-------------	----------------

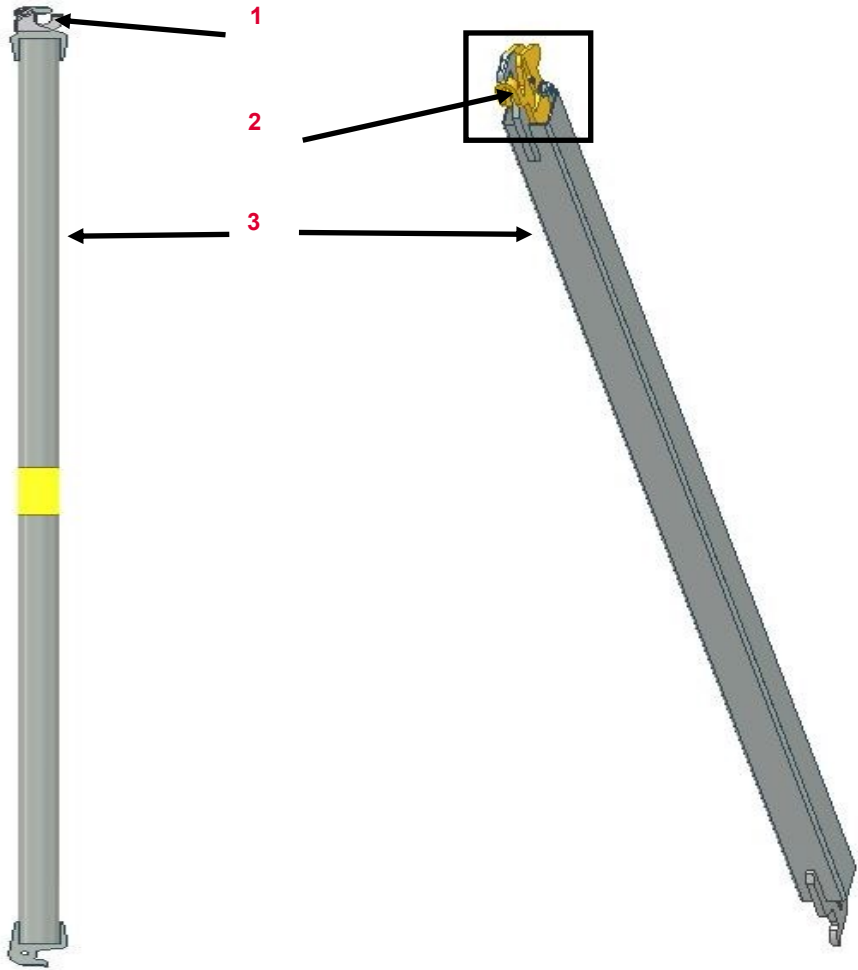

1	Latch UBH	
2	Slider UBH	114874
3	Tube	
4	Bolt M 8x35	114862
5	Dowel pin	780807
6	Nut	114861

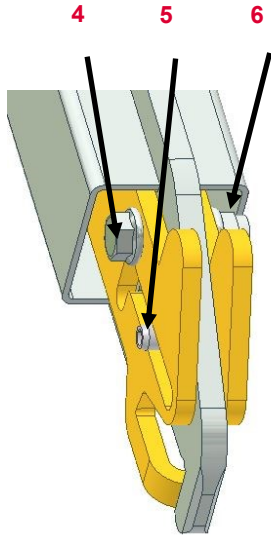

# PERI Rental Criteria

## PERI UP Basic Components











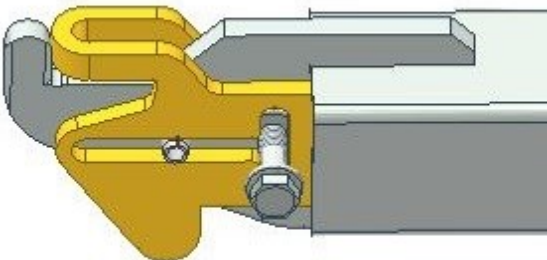

Artikel	Artikelnummer
Horizontal Brace UBH 150/150	100042
Horizontal Brace UBH 200/150	107815
Horizontal Brace UBH 250/150	106931
Horizontal Brace UBH 300/150	100051
Horizontal Brace UBH 200/200	100047
Horizontal Brace UBH 250/200	104356
Horizontal Brace UBH 300/200	123483
Horizontal Brace UBH 250/250	100049
Horizontal Brace UBH 300/300	100053
Horizontal Brace UBH FLEX 250/75	114896
Horizontal Brace UBH FLEX 300/75	114900
Horizontal Brace UBH FLEX 100/100	114818
Horizontal Brace UBH FLEX 150/100	114821
Horizontal Brace UBH FLEX 200/100	114820

Artikel	Artikelnummer
Horizontal Brace UBH FLEX 250/100	114819
Horizontal Brace UBH FLEX 300/100	114892
Horizontal Brace UBH FLEX 125/125	114904
Horizontal Brace UBH FLEX 150/125	114908
Horizontal Brace UBH FLEX 250/125	114996
Horizontal Brace UBH FLEX 150/150	114912
Horizontal Brace UBH FLEX 200/200	114916
Horizontal Brace UBH FLEX 250/200	114920
Horizontal Brace UBH FLEX 300/200	114924
Horizontal Brace UBH FLEX 250/250	114928
Horizontal Brace UBH FLEX 300/250	114932
Horizontal Brace UBH FLEX 300/300	114936
Horizontal Brace UBH FLEX 200/150	124097
Horizontal Brace UBH FLEX 250/150	124101
Horizontal Brace UBH FLEX 300/150	124105

# PERI Rental Criteria

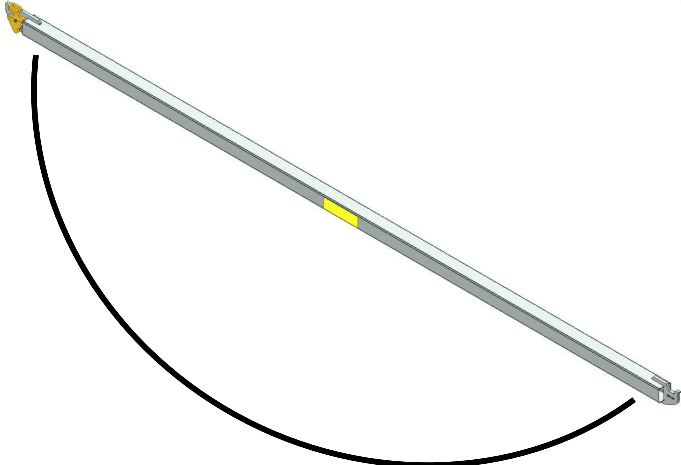
## PERI UP Basic Components















Horizontal Brace	Description	Instruction	Billing Condition	Type
	<p><b>Latch   Slider unusable</b></p> <ul style="list-style-type: none"> <li>■ UBH</li> <li>■ Or at UBH Flex</li> </ul>	<ul style="list-style-type: none"> <li></li> <li></li> </ul>	<ul style="list-style-type: none"> <li></li> <li></li> </ul>	<ul style="list-style-type: none"> <li></li> <li></li> </ul>
	<p><b>Tube completely bent</b></p> <ul style="list-style-type: none"> <li>■ &lt; 5 mm (l/500)</li> </ul>	<ul style="list-style-type: none"> <li></li> <li></li> </ul>	<ul style="list-style-type: none"> <li></li> </ul>	<ul style="list-style-type: none"> <li></li> </ul>

# PERI Rental Criteria

## PERI UP Basic Components



Castor UEW (101858   101860)	Description	Instruction	Billing Condition	Type
	<p><b>Sawn-off   bent Spindle</b></p> <ul style="list-style-type: none"> <li>■ Remaining length &gt; 150 mm</li> <li>■ Or remaining length &lt; 150 mm</li> </ul>	<p>Remove the cam nut use as castor with wheel (rebook)</p>		
	<p><b>Spindle broken off</b></p>	 		
	<p><b>Wheel broken   Overload through wrong use</b></p>	 		

# PERI Rental Criteria

## PERI UP Basic Components



Castor UEW (101858   101860)	Description	Instruction	Billing Condition	Type
------------------------------	-------------	-------------	-------------------	------



Cam nut broken



Brake not functional



# PERI Rental Criteria

## PERI UP Basic Components



Latt. Girder Steel ULS   Alu ULA	Nr.	Description	Article number
----------------------------------	-----	-------------	----------------

















1	Main chord	
2	Post	
3	Diagonal	

Valid for	Article number
Latt. Girder Steel ULS 50/425	100330
Latt. Girder Steel ULS 50/525	100336
Latt. Girder Steel ULS 50/625	100339
Latt. Girder Steel ULS 70/525	100185
Latt. Girder Steel ULS 70/625	100183
Latt. Girder Steel ULS 70/825	100852
Latt. Girder Alu ULA 50/425 HD	101656
Latt. Girder Alu ULA 50/525 HD	101657
Latt. Girder Alu ULA 50/625 HD	101658
Latt. Girder Alu ULA 50/825 HD	101659

# PERI Rental Criteria

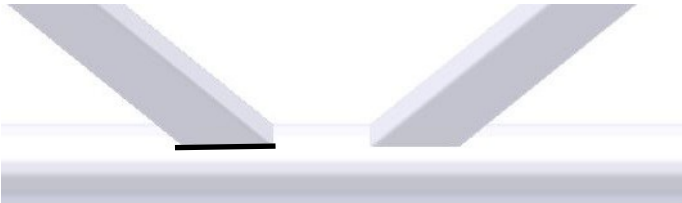
## PERI UP Basic Components



















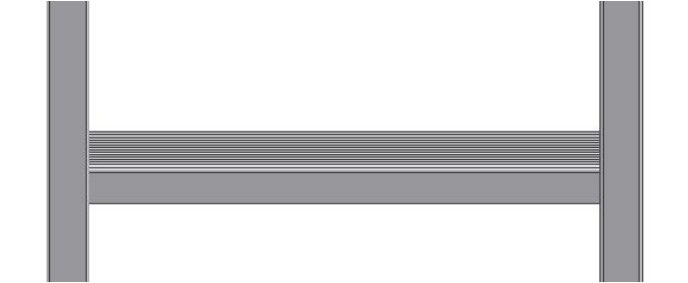



Lattice Girder	Description	Instruction	Billing Condition	Type										
	<p><b>Lattice girder bent</b></p> <p>■ &gt; permitted bend (L/500)</p>	 												
	<table border="1"> <thead> <tr> <th data-bbox="887 579 965 604">Length</th> <th data-bbox="1312 579 1435 604">Perm. bend</th> </tr> </thead> <tbody> <tr> <td data-bbox="887 624 927 643">425</td> <td data-bbox="1312 624 1368 643">9 mm</td> </tr> <tr> <td data-bbox="887 663 927 683">525</td> <td data-bbox="1312 663 1379 683">11 mm</td> </tr> <tr> <td data-bbox="887 703 927 722">625</td> <td data-bbox="1312 703 1379 722">13 mm</td> </tr> <tr> <td data-bbox="887 743 927 762">825</td> <td data-bbox="1312 743 1379 762">17mm</td> </tr> </tbody> </table>	Length	Perm. bend	425	9 mm	525	11 mm	625	13 mm	825	17mm			
Length	Perm. bend													
425	9 mm													
525	11 mm													
625	13 mm													
825	17mm													
	<p><b>Diagonal bent</b></p>	 												
	<p><b>Weld cracked</b></p>	 												



# PERI Rental Criteria

## PERI UP Basic Components











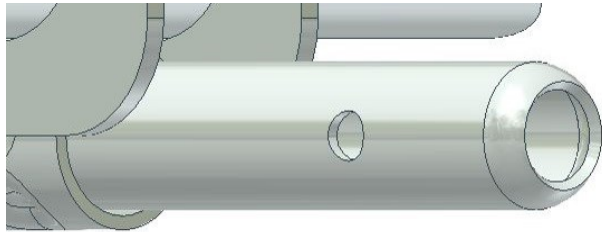



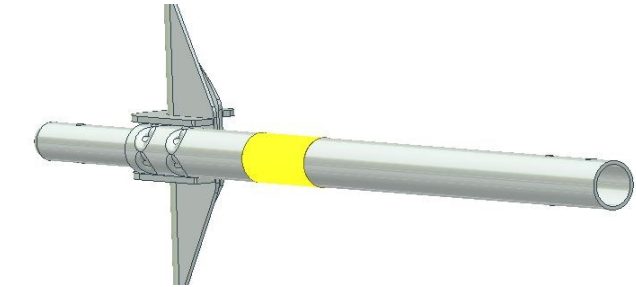

Ladder Flex UEL (126318)	Description	Instruction	Billing Condition	Type
	<b>Mounting bent/broken</b>			
	<ul style="list-style-type: none"> <li>Without damage to base material</li> </ul>			
	<ul style="list-style-type: none"> <li>Or with damage</li> </ul>			
	<b>Step bent</b>			
	<b>Crack in welding</b>			
	<ul style="list-style-type: none"> <li>Without damage to ladder or step</li> </ul>			
	<ul style="list-style-type: none"> <li>Or with damage to ladder or step</li> </ul>			

# PERI Rental Criteria

## PERI UP Basic Components











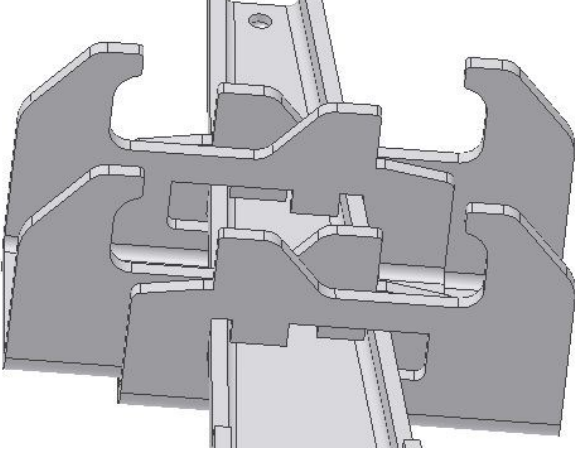

Base on Lattice Girder (100529)	Description	Instruction	Billing Condition	Type
	<b>Spigot bent/dented</b>			
	<ul style="list-style-type: none"> <li>■ Insertion impossible</li> </ul>	 		
	<ul style="list-style-type: none"> <li>■ Or <math>d &gt; 3 \text{ mm}</math></li> </ul>	 		
	<b>Pipe bent   dented</b>			
	<ul style="list-style-type: none"> <li>■ <math>\varnothing &gt; 3 \text{ cm}</math></li> </ul>	 		
	<ul style="list-style-type: none"> <li>■ Or <math>t &gt; 3 \text{ mm}</math></li> </ul>	 		
	<b>Sheet bent</b>			
	<ul style="list-style-type: none"> <li>■ If possible</li> </ul>			
	<ul style="list-style-type: none"> <li>■ Or if no longer possible</li> </ul>	 		

# PERI Rental Criteria

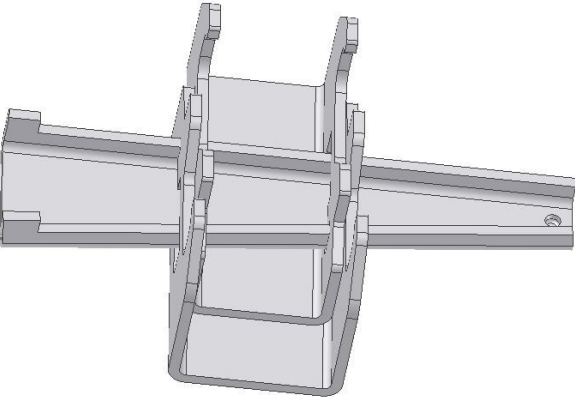
## PERI UP Basic Components



Deck Link Plate UDC (111011)	Description	Instruction	Billing Condition	Type
	<p><b>Claws bent</b></p> <ul style="list-style-type: none"> <li>■ If possible</li> <li>■ Or if no longer possible</li> </ul>	<p>     </p>	<p>     </p>	<p>     </p>
	<p><b>Wedge bent   not movable</b></p>	<p></p>	<p></p>	<p></p>

# PERI Rental Criteria

## PERI UP Basic Components



Wall Tie UWT	Nr.	Description	Article number
--------------	-----	-------------	----------------

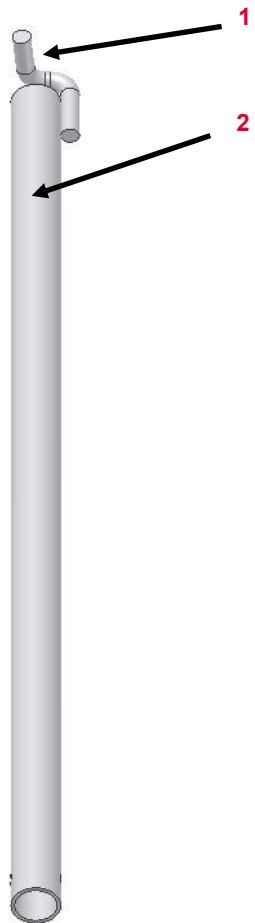

1	Hook
2	Pipe

Gültig für	Artikelnummer
Wall Tie UWT 45	100088
Wall Tie UWT 70	138285
Wall Tie UWT 110	100091
Wall Tie UWT 140	100093
Wall Tie UWT 170	102951
Wall Tie UWT 220	102954
Wall Tie UWT 270	102957

# PERI Rental Criteria

## PERI UP Basic Components



Wall Tie UWT	Description	Instruction	Billing Condition	Type
--------------	-------------	-------------	-------------------	------



**Hook rusty**

- Welding undamaged



Remove the rust and renew the zinc layer



**Wall Tie bent**

- > permitted bent (l/500)











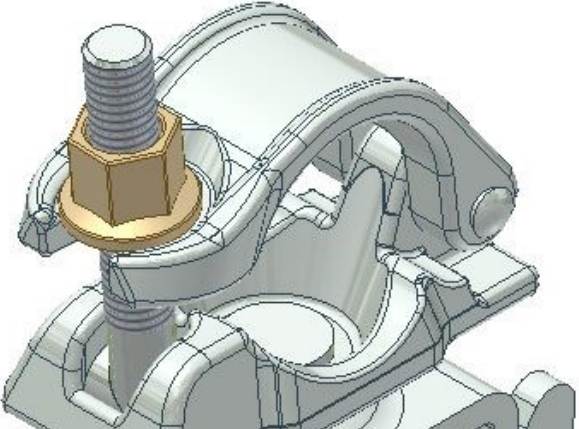

Article	Perm. Bent
UWT 45	3,0 mm
UWT 110	3,0 mm
UWT 140	3,0 mm
UWT 170	4,0 mm
UWT 220	4,0 mm
UWT 270	5,0 mm

# PERI Rental Criteria

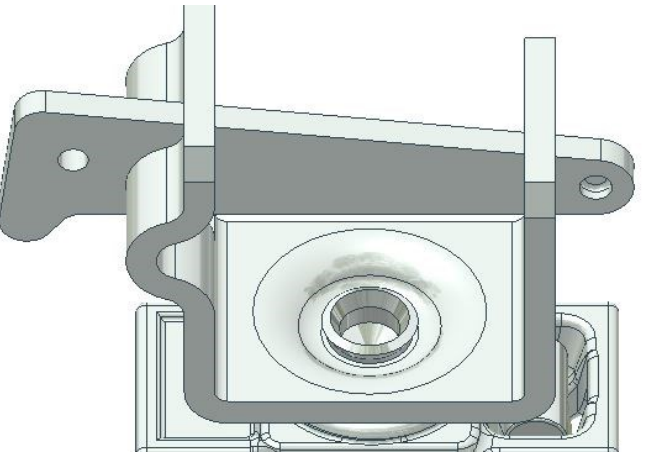
## PERI UP Basic Components











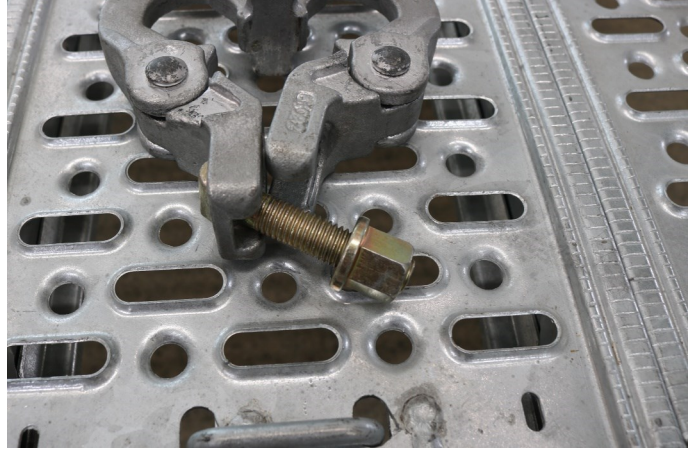





Coupling for UH (105824)	Description	Instruction	Billing Condition	Type
	<p><b>Hammer head bolt   Nut</b></p> <ul style="list-style-type: none"> <li>■ Missing</li> <li>■ Not usable</li> </ul>	<ul style="list-style-type: none"> <li>            710702 (Bolt) 710340 (Nut)         </li> <li>            710702 (Bolt) 710340 (Nut)         </li> </ul>	<ul style="list-style-type: none"> <li>  </li> <li>  </li> </ul>	<ul style="list-style-type: none"> <li>  </li> <li>  </li> </ul>
	<p><b>Wedge missing</b></p>			

# PERI Rental Criteria

## PERI UP Basic Components













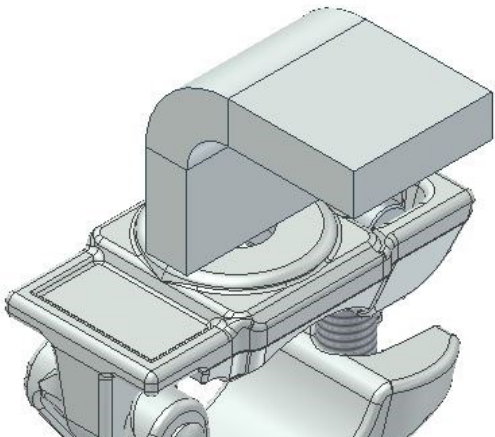



Rosett Coupler UEV 90   180 (126453   116306)	Description	Instruction	Billing Condition	Type
	<p><b>Hammer head bolt/Nut</b></p> <ul style="list-style-type: none"> <li>■ Missing</li> <li>■ Or not usable</li> </ul>	<ul style="list-style-type: none"> <li>            117475 (Bolt) 118091 (Nut)         </li> <li>            117475 (Bolt) 118091 (Nut)         </li> </ul>	<ul style="list-style-type: none"> <li>  </li> <li>  </li> </ul>	<ul style="list-style-type: none"> <li>  </li> <li>  </li> </ul>
	<p><b>Coupling not movable</b></p> <ul style="list-style-type: none"> <li>■ Damage through force (Bending)</li> <li>■ Or damage through wear (Rust)</li> </ul>	<ul style="list-style-type: none"> <li>  </li> <li>  </li> </ul>	<ul style="list-style-type: none"> <li>  </li> <li>  </li> </ul>	<ul style="list-style-type: none"> <li>  </li> <li>  </li> </ul>

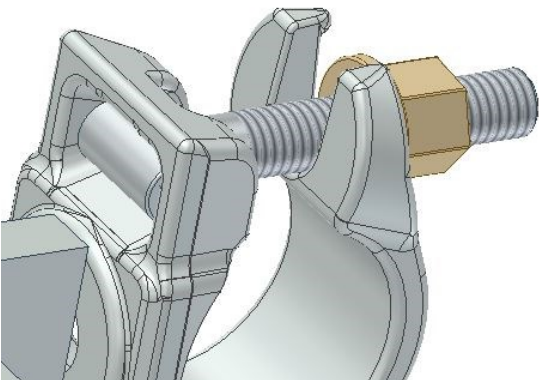

# PERI Rental Criteria

## PERI UP Basic Components



Flange Coupler UEC (113726)	Description	Instruction	Billing Condition	Type
	<p><b>Bracket bent</b></p>			
	<ul style="list-style-type: none"> <li>■ If possible</li> </ul>			
	<ul style="list-style-type: none"> <li>■ Or if no longer possible</li> </ul>	 		
	<p><b>Hammer head bolt   Nut</b></p>			
	<ul style="list-style-type: none"> <li>■ Missing</li> </ul>	 <p>710702 (Bolt) 710340 (Nut)</p>		
<ul style="list-style-type: none"> <li>■ Or not usable</li> </ul>	 <p>710702 (Bolt) 710340 (Nut)</p>			

# PERI Rental Criteria

## PERI UP Basic Components



Access Deck UAW –L		Nr.	Description	Article number
--------------------	--	-----	-------------	----------------

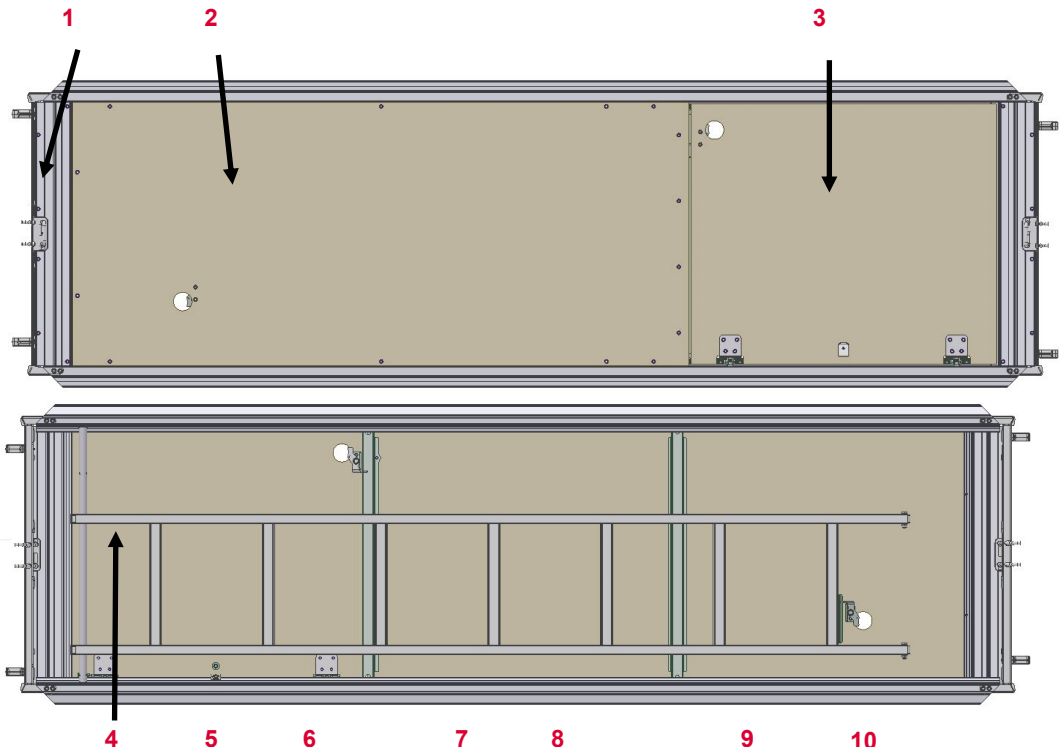

1	Hinge	132971
2	Board	
3	Hatch	132977
4	Ladder	133158
5	Latch	132598
6	Latch Profile	132588
7	Joint Bracket	132586
8	Joint	132606
9	Strap EPDM	132587
10	Rivet	722318

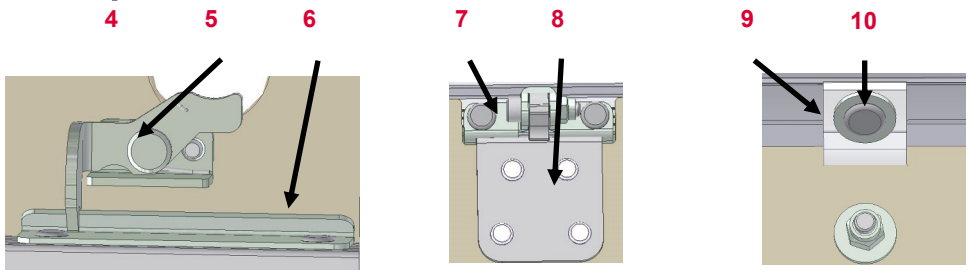

Valid for	Article number
Access Deck UAW 75x150-L	134046
Access Deck UAW 75x200-L	132996
Access Deck UAW 75x250-L	130334
Access Deck UAW 75x300-L	133309

# PERI Rental Criteria

## PERI UP Basic Components



Access Deck UAA-L		Nr.	Description	Article number
-------------------	--	-----	-------------	----------------

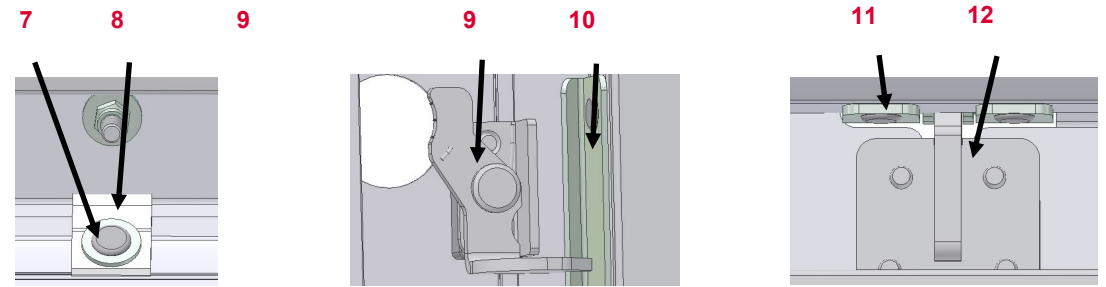
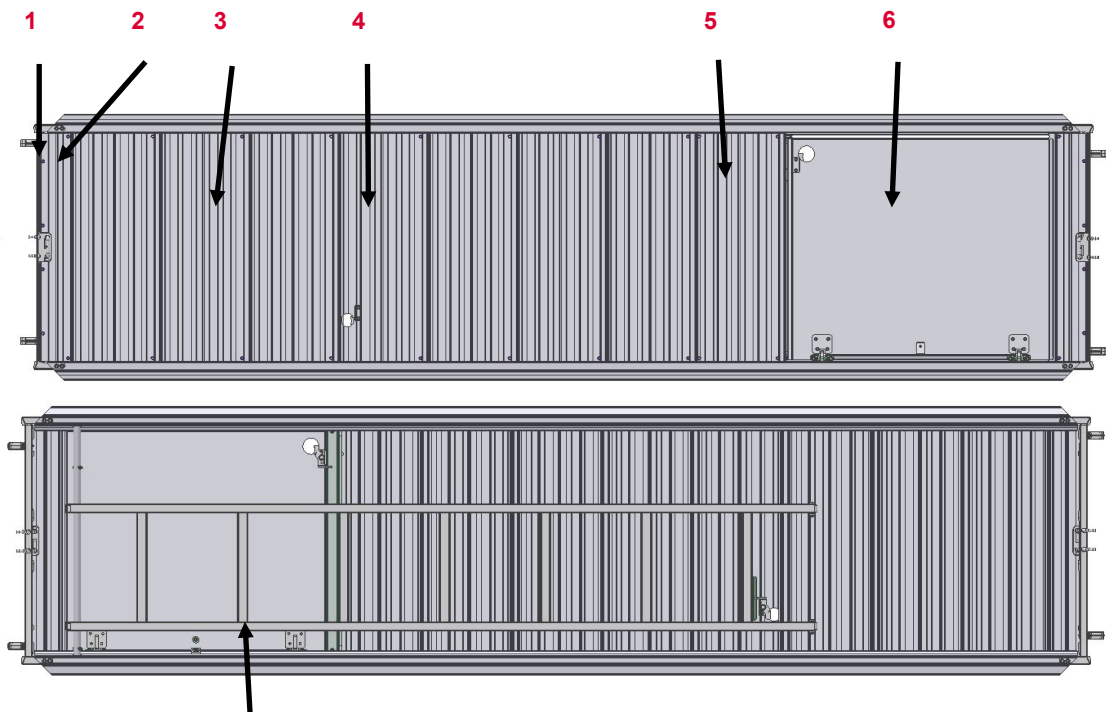

















1	Hinge	132971
2	Start Profile	132973
3	Profile	132986
4	Ladder Profile	132985
5	End Profile	133469
6	Hatch Alu	132984
7	Rivet	722318
8	Strap EPDM	132587
9	Latch	132598
10	Latch Profile	132588
11	Joint Bracket	132586

Valid for	Article number
Access Deck UAA 75x150-L	132993
Access Deck UAA 75x200-L	132990
Access Deck UAA 75x250-L	133314
Access Deck UAA 75x300-L	133315

# PERI Rental Criteria

## PERI UP Basic Components



Access Deck UAA   UAW	Description	Instruction	Billing Condition	Type
	<b>Strap</b>			
	<ul style="list-style-type: none"> <li data-bbox="846 566 1294 630">■ Worn</li> <li data-bbox="846 694 1294 742">■ Or cut off</li> </ul>	  	  	  
	<b>Claws of the hinge</b>			
	<ul style="list-style-type: none"> <li data-bbox="846 1077 1294 1141">■ Without cracks in claw and bent <math>\leq 5</math> mm</li> </ul>			
	<ul style="list-style-type: none"> <li data-bbox="846 1197 1294 1228">■ Or bent <math>&gt; 5</math> mm</li> </ul>			
<ul style="list-style-type: none"> <li data-bbox="846 1324 1294 1356">■ Or cracks in claw</li> </ul>				

# PERI Rental Criteria

## PERI UP Basic Components



Access Deck UAA   UAW	Description	Instruction	Billing Condition	Type
-----------------------	-------------	-------------	-------------------	------



Latch defect



Hatch

- Worn
- Or damaged due to force



















# PERI Rental Criteria

## PERI UP Basic Components













Access Deck UAA   UAW	Description	Instruction	Billing Condition	Type
	<b>Ladder</b>			
	<ul style="list-style-type: none"> <li data-bbox="846 566 1294 614">■ Missing</li> <li data-bbox="846 710 1294 774">■ Or cracks in welding</li> </ul>	  	  	  
	<b>Joint   Joint Bracket</b>			
	<ul style="list-style-type: none"> <li data-bbox="846 1088 1294 1136">■ Missing</li> <li data-bbox="846 1232 1294 1295">■ Or damaged due to force (function disturbed)</li> </ul>	  	  	  

# PERI Rental Criteria

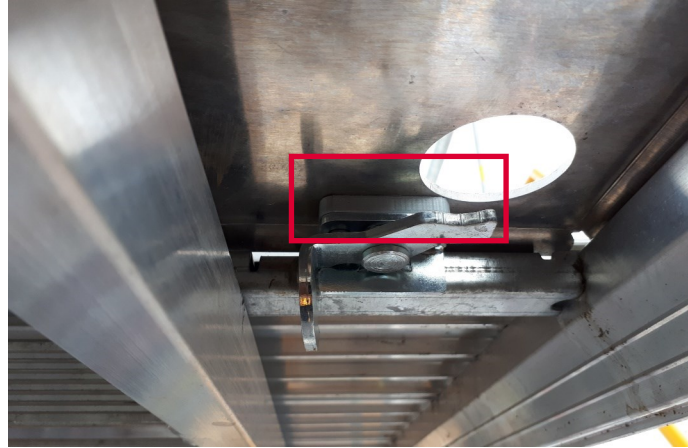
## PERI UP Basic Components









Access Deck UAA	Description	Instruction	Billing Condition	Type
	<b>Aluminium Profile</b>			
	<ul style="list-style-type: none"> <li>■ Cracks in profile</li> </ul>			
	<ul style="list-style-type: none"> <li>■ Or holes &gt; Ø 5 mm</li> </ul>			
	<b>Block missing</b>			
		133014 (Block)		



# PERI Rental Criteria

## PERI UP Basic Components



Access Deck UAW	Description	Instruction	Billing Condition	Type
	<p><b>Wood Board</b></p> <ul style="list-style-type: none"> <li>■ Worn</li> <li>■ Or damaged due to force (cracks or holes &gt; Ø 5 mm )</li> </ul>	<p>Worn: </p> <p>Damaged: </p>	<p>Worn: </p> <p>Damaged: </p>	<p>Worn: </p> <p>Damaged: </p>

# PERI Rental Criteria

## PERI UP Basic Components



Coupling UH 30/60 (137211)	Description	Instruction	Billing Condition	Type
----------------------------	-------------	-------------	-------------------	------

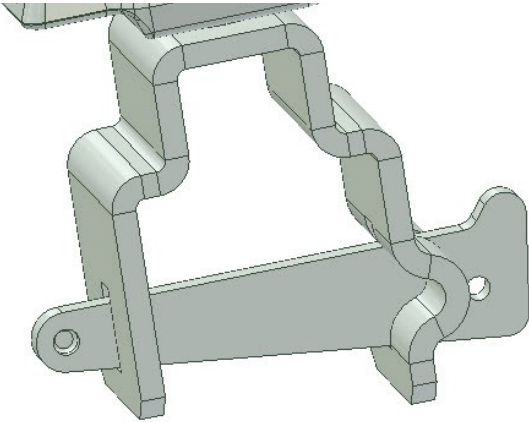

**Bracket bent**

- If possible
- Or if not possible

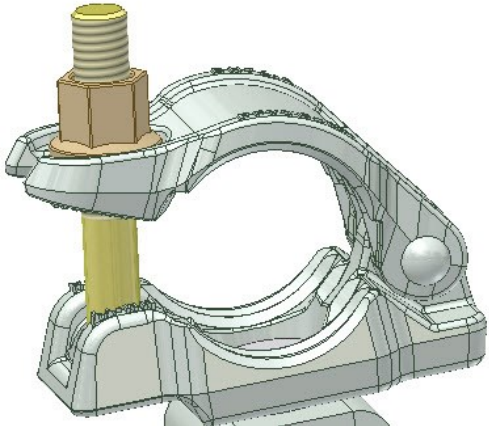

**Hammer Head Bolt | Nut**

- Missing
- Or damaged due to force



# PERI Rental Criteria

## PERI UP Basic Components



Couplings	Nr.	Description	Article number
-----------	-----	-------------	----------------

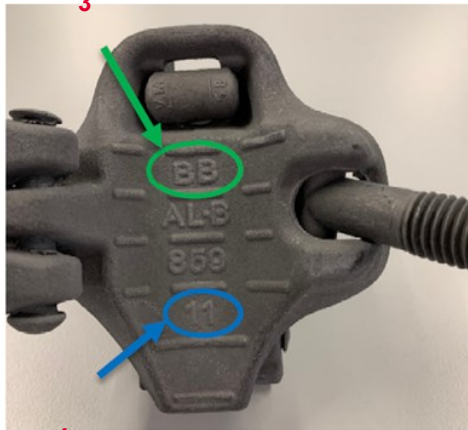

1	Reference to EN 74
2	Name or trademark of manufacturer. <b>It does not necessarily have to be PERI</b>
3	
4	Quality grade of coupling
	Year of manufacturer

2

4

Valid for

RED.SWIVEL COUPLER RS38/48 GV	102400
SWIVEL COUPLER SW 48/48 GALV.	017010
RED.SWIVEL COUPLER RS60/48 GV	017000
RED.SWIVEL COUPLER RS33,7/38GV	017070
STANDARD COUPLER RA 48/48 GALV	017020
RED.STANDARD COUPLER RR60/48GV	017030
HALF COUPLER W.BOLT DK 48,GALV	017040

# PERI Rental Criteria

## PERI UP Basic Components











Couplings	Description	Instruction	Billing Condition	Type
	<p><b>Markings</b></p> <ul style="list-style-type: none"> <li>■ Given</li> <li>■ Or not given</li> </ul>	<ul style="list-style-type: none"> <li>■ </li> <li>■  </li> </ul>	<ul style="list-style-type: none"> <li>■ </li> <li>■ </li> </ul>	<ul style="list-style-type: none"> <li>■ </li> <li>■ </li> </ul>
	<p><b>Hammer Head Bolt   Nut</b></p> <ul style="list-style-type: none"> <li>■ Missing</li> <li>■ Or damaged due to force</li> <li>■ Or not moveable du to weariness (rust)</li> </ul>	<ul style="list-style-type: none"> <li>■ </li> <li>■ </li> <li>■ </li> </ul>	<ul style="list-style-type: none"> <li>■ </li> <li>■ </li> <li>■ </li> </ul>	<ul style="list-style-type: none"> <li>■ </li> <li>■ </li> <li>■ </li> </ul>

# PERI Rental Criteria

## PERI UP Basic Components











Couplings	Description	Instruction	Billing Condition	Type
	<p>Coupling half shell damaged</p>			
	<p>Swivel element damaged</p>			

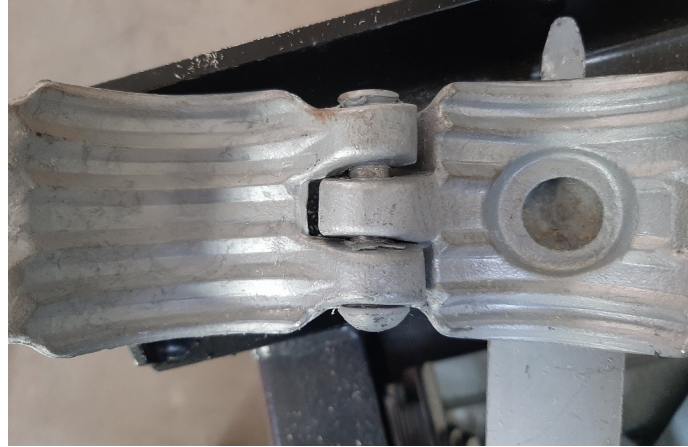

# PERI Rental Criteria

## PERI UP Basic Components















Couplings	Description	Instruction	Billing Condition	Type
	<p><b>Internal fluting defect.</b></p> <p>If there is no fluting, this type of damage does not apply and the coupling can remain in the rental park</p>	 		
	<p><b>Hinge Rivet damaged</b></p>	 		

# PERI Rental Criteria

## PERI UP Basic Components











Scaffolding Tube	Description	Instruction	Billing Condition	Type
	<b>Bent</b> <ul style="list-style-type: none"> <li>■ &lt; L/200</li> </ul>			
	<ul style="list-style-type: none"> <li>■ Or &gt; L/200</li> </ul>	 		
	<b>Shortened on jobsite</b>			



# PERI Rental Criteria

## PERI UP Basic Components



Scaffolding Tube	Description	Instruction	Billing Condition	Type
	<b>Holes in tubes</b>			
	<ul style="list-style-type: none"> <li>■ If possible</li> </ul>			
	<ul style="list-style-type: none"> <li>■ Or if not possible</li> </ul>	 		

# PERI Rental Criteria

## PERI UP Basic Components



Deck Traverse UDT (136794   136786   136790)	Description	Instruction	Billing Condition	Type
--	-------------	-------------	-------------------	------

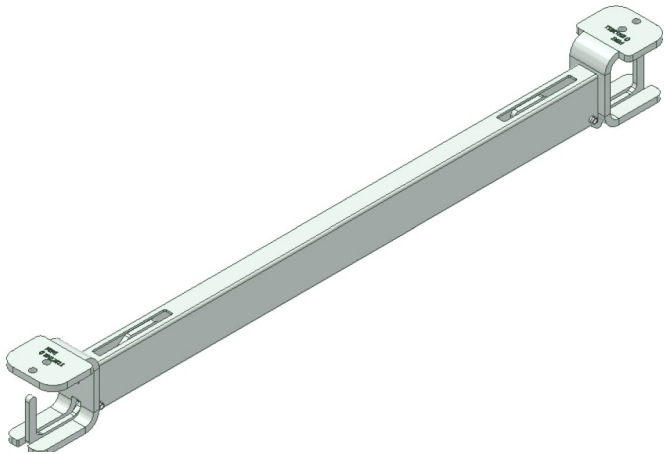

**Bent**

- If possible
- Or if not possible

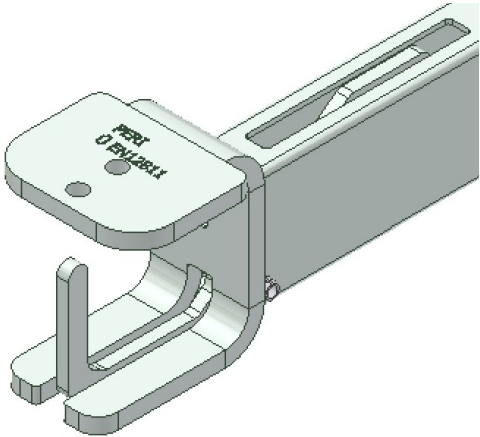

**Safety Latch**

















- Missing
- Or damaged due to force



# PERI Rental Criteria

## Glossar Icons



Icon	Significance	Icon	Significance	Icon	Significance
	Not Ok– material is scrap		Billing necessary (customer)		Optical damage
	OK– material stays in rental park		No Billing necessary		Functional damage
	Scrap material– it's not permitted to hand out the material because of safety aspects		Shorten the material		Functional damage— it's <b>not</b> permitted to hand out the material
	Repair according to instruction		Mark the material		Static damage— it's <b>not</b> permitted to hand out the material
	Fix material cold– Afterwards check weld seams and bordering components		Replace damaged material		
	Repair after local economic efficiency calculation		Replace missing material		
	Clean the material				