

PERI Rental Criteria

TRIO

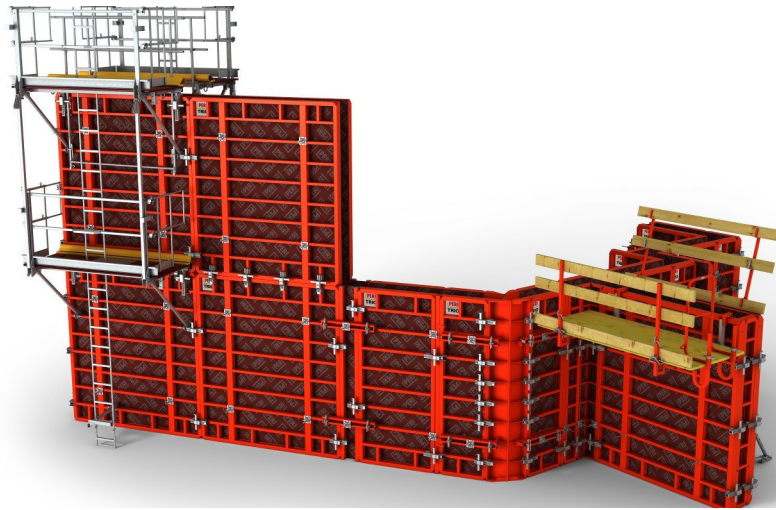

Contact

PERI GmbH
Formwork Scaffolding
Engineering
 P.O. Box 1264
 89264 Weissenhorn, Germany
 Phone +49 (0) 7309.950-0
 Fax +49 (0) 7309.951-0
rental-criteria@peri.de

Content	Page	Changes	Date Initial	Page
Frame damages steel	2	New version	09/2015 fw	
Frame damages aluminium	13			
TRIO articulated corner	20			
TRIO corner element	23			
Wall thickness compensation	25			
Stop end panel	33			
TRIO concrete platform	41			
Shaft elements	44			
Accessories	47			

PERI Rental Criteria

TRIO



TRIO Frame	No.	Name	Article number
------------	-----	------	----------------

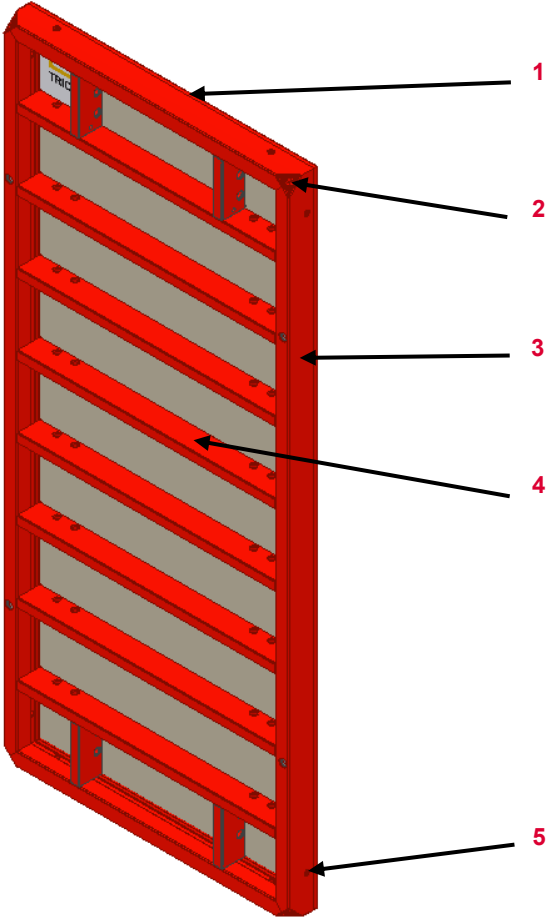

1	Front profile	
2	Levering Corner	750580
3	Length profile	
4	Brace	
5	Sleeve	750127

PERI Rental Criteria

TRIO















Article	Article number
Element TR/4 330x240	054304
Element TR/4 330x120	054314
Element TR/4 330x90	054324
Element TR/4 330x72	054334
Element TR/4 330x60	054354
Element TR/4 330x30	054364
Element TRM/4 330x72	054344
Stop end panel TR/4 330x24	023050
Element TR 270x240	022570
Element TR 270x120	022510
Element TR 270x90	022520
Element TR 270x72	022530
Element TR 270x60	022550
Element TR 270x30	022560
Element TRM 270x 72	022540
Stop end panel TR 270x24	023040















Article	Article number
Element TR 120x240	022514
Element TR 120x120	022600
Element TR 120x90	022610
Element TR 120x72	022620
Element TR 120x60	022640
Element TR 120x30	022650
Element TRM 120x72	022630
Stop end panel TR 120x24	023030
Element TR60x90	022790
Element TR60x72	022800
Element TR60x60	022810
Element TR60x30	022820

PERI Rental Criteria

TRIO

















Frame damages	Description	Instruction	Billing Condition	Type
	<p>27.01 Profile parts or braces torn out</p>	 		
	<p>27.02 Front profile deformed</p> <ul style="list-style-type: none"> ■ Kink caused by lifting hook ■ Or damages caused by force 	 	 See table (p. 11)  See table (p. 11)	 







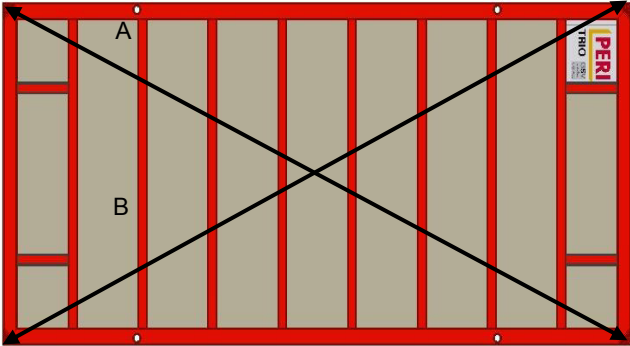

Frame damages	Description	Instruction	Billing Condition	Type	
	27.03 Length profile deformed	 			
	<ul style="list-style-type: none"> ■ Kink caused by lifting hook. Lifting hook has no function anymore 				
	27.04 Holes in the elements				
	<ul style="list-style-type: none"> ■ $\leq \text{Ø } 3 \text{ cm}$ 				088028
	<ul style="list-style-type: none"> ■ Or $> \text{Ø } 3 \text{ cm}$ at the length profile 				 
<ul style="list-style-type: none"> ■ Or $> \text{Ø } 3 \text{ cm}$ at the front profile or brace 			See table (p 11+ 12)		

PERI Rental Criteria

TRIO

















Frame damages	Description	Instruction	Billing Condition	Type
	<p>27.05 Kink at the brace</p>		 See table (p. 12)	
	<p>27.06 Sleeve at the brace damaged, torn out</p> <ul style="list-style-type: none"> ■ If bending is possible ■ Or if bending is impossible ■ Or torn out sleeve 	<ul style="list-style-type: none">    	<ul style="list-style-type: none">  088244  See table (p. 12)  See table (p. 12) 	<ul style="list-style-type: none">   

Frame damages	Description	Instruction	Billing Condition	Type
	<p>27.07 Element bent diagonally</p> <ul style="list-style-type: none"> ■ Difference between A and B > 6 mm 			
	<p>27.08 Element bent</p> <ul style="list-style-type: none"> ■ > 8 mm 			

PERI Rental Criteria

TRIO























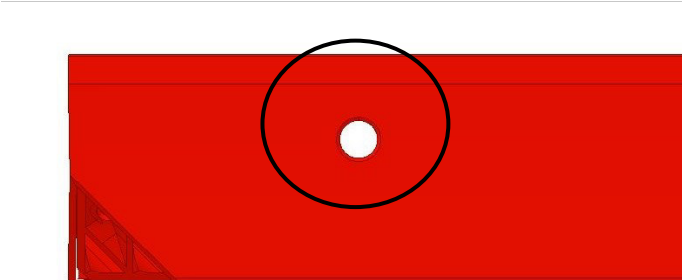

Frame damages	Description	Instruction	Billing Condition	Type
	27.09 Dent in profile	<ul style="list-style-type: none"> ■ ≤ 5 mm depth 		
	<ul style="list-style-type: none"> ■ Or > 5 mm depth 	<ul style="list-style-type: none">   	<ul style="list-style-type: none">  088027 	<ul style="list-style-type: none"> 
	27.10 Dent in profile edge	<ul style="list-style-type: none"> ■ > 3 mm until ≤ 10 mm 	<ul style="list-style-type: none">  088236 	<ul style="list-style-type: none"> 
	<ul style="list-style-type: none"> ■ Or > 10 mm 	<ul style="list-style-type: none">   Remove plywood 	<ul style="list-style-type: none">  088236 	<ul style="list-style-type: none"> 

PERI Rental Criteria

TRIO



Frame damages	Description	Instruction	Billing Condition	Type
	<p>27.11 Crack in the welding</p>		 088028	
	<p>27.12 Crack in the profile edge</p> <ul style="list-style-type: none"> ■ With bended profile edge ■ Or without damaged profile edge 	 	 088028  088028	 

Frame damages	Description	Instruction	Billing Condition	Type	
	27.13 Levering corner deformed		 088176		
	27.14 Sleeve missing, damaged		 088002		
	27.15 Hole in frame caused by rust	<ul style="list-style-type: none"> ■ Test with 300 g hammer and peen 			

PERI Rental Criteria

TRIO



Article	Front profile	
	Spare part	Service article number
Front profile 30	109106	088049
Front profile 60	109031	088051
Front profile 90	109023	088052
Front profile 120	109021	088053
Front profile 240	745051	088054
Front profile 270	745050	088055

PERI Rental Criteria

TRIO



Article	Strut	
	Spare part	Service article number
Brace 18	745357	088038
Brace 19	112479	088039
Brace 22	745356	088040
Brace 43	745355	088043
Brace 48	745354	088044
Brace 78	745352	088046
Brace 122	745350	088047
Brace 60	745353	088232
Brace 23	745358	

PERI Rental Criteria

TRIO



TRIO Aluminium Frame	No.	Name	Article number
----------------------	-----	------	----------------

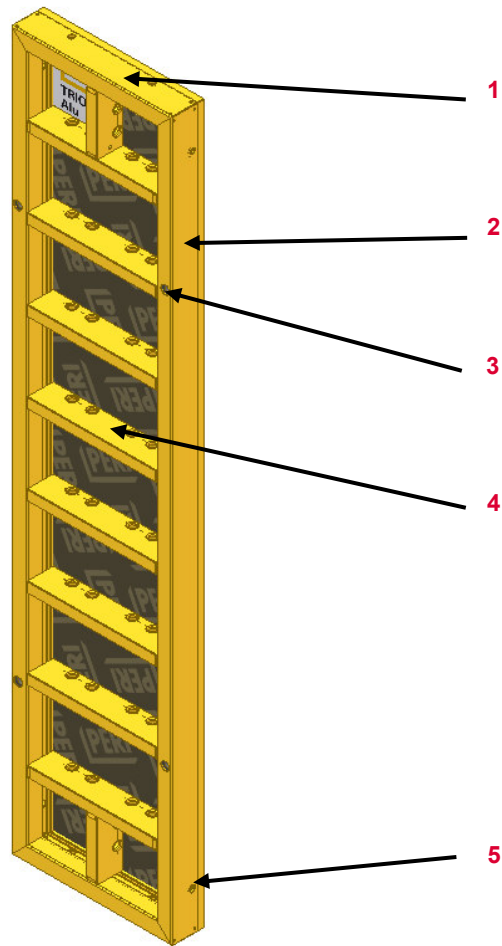









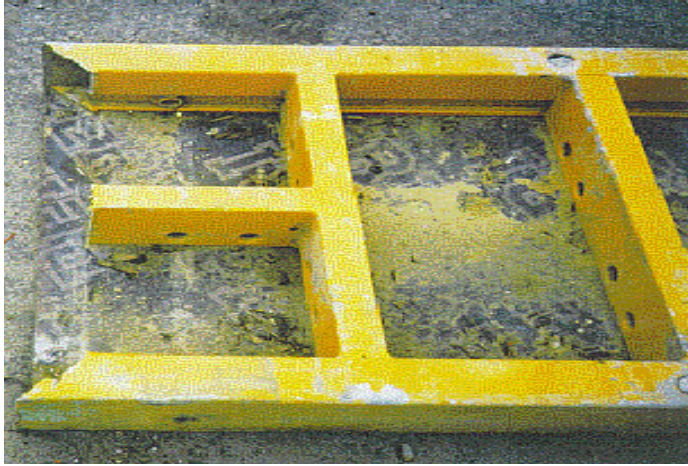

1	Front profile	
2	Length profile	
3	Sleeve 18	710160
4	Brace	
5	Sleeve 8	750120

Valid for	Article number
Element TRA 270x90	023850
Element TRA 270x60	023870
Element TRA 270x30	023880
Element TRA 90x120	023900
Element TRA 90x60	023950
Element TRA 90x30	023960
Multi panel TAM 270x72	023860
Multi panel TAM 90x72	023980

PERI Rental Criteria

TRIO













Frame damages	Description	Instruction	Billing Condition	Type
	<p>27.16 Profile parts, braces torn out</p>			
	<p>27.17 Damaged front profile</p> <ul style="list-style-type: none"> ■ Kink caused by lifting hook ■ Or damaged caused by force 	 	 	 

PERI Rental Criteria

TRIO











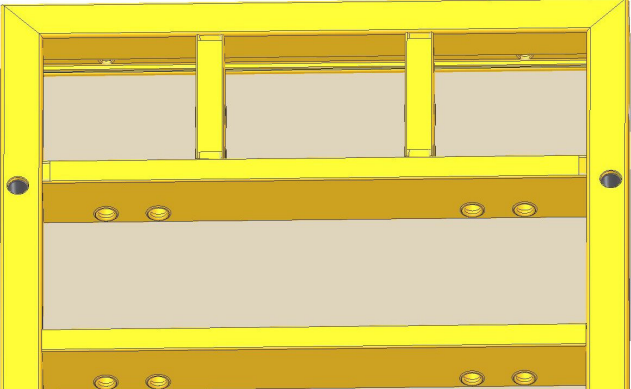



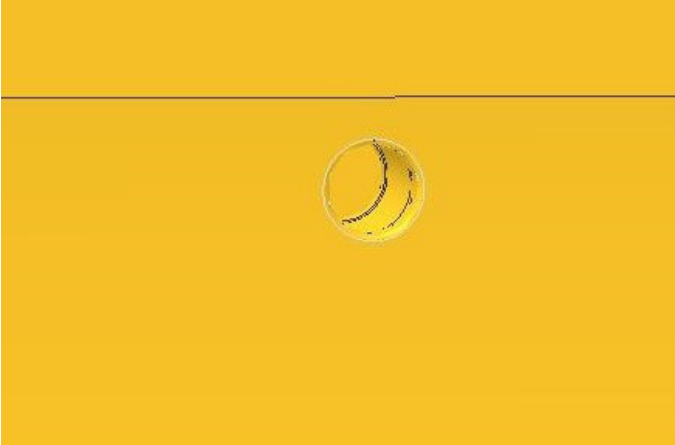







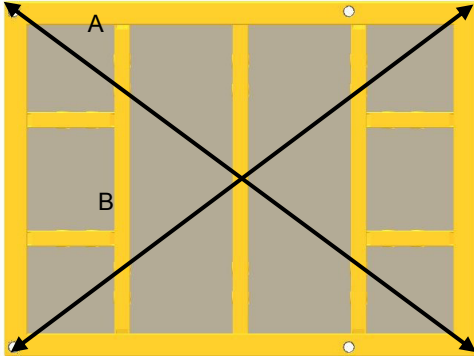

Frame damages	Description	Instruction	Billing Condition	Type
	27.18 Damaged length profile			
	<ul style="list-style-type: none"> ■ Kink caused by lifting hook 	 		
	<ul style="list-style-type: none"> ■ Or caused by force 	 		
	27.19 Holes in the element			

PERI Rental Criteria

TRIO

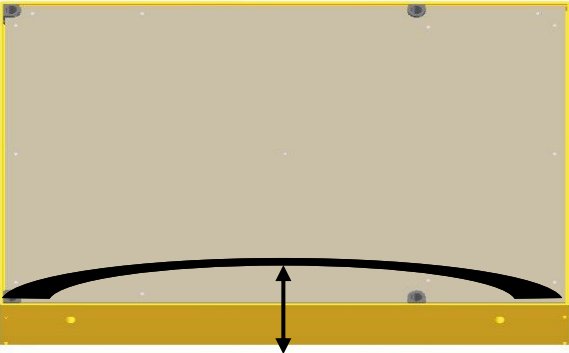

















Frame damages	Description	Instruction	Billing Condition	Type
	<p>27.20 Kink in the brace</p>			
	<p>27.21 Sleeve at the brace damaged, torn out</p> <ul style="list-style-type: none"> ■ If bending is possible ■ Or if bending is impossible ■ Or sleeve torn out 	<ul style="list-style-type: none">    	<ul style="list-style-type: none">  088244  088002  088002 	<ul style="list-style-type: none">   

Frame damages	Description	Instruction	Billing Condition	Type	
	27.22 Element bent diagonally	<ul style="list-style-type: none"> ■ Difference between A and B > 6 mm 			
	27.23 Element bent	<ul style="list-style-type: none"> ■ > 8 mm 			

PERI Rental Criteria

TRIO











Frame damages	Description	Instruction	Billing Condition	Type
	27.24 Dent in the profile			
	<ul style="list-style-type: none"> ■ ≤ 5 mm depth 	 		
	<ul style="list-style-type: none"> ■ Or > 5 mm depth 		 088027	
	27.25 Dent in the profile edge			
	<ul style="list-style-type: none"> ■ ≤ 3 mm 	 		
	<ul style="list-style-type: none"> ■ Or > 3 mm until ≤ 10 mm 		 0882636	
	<ul style="list-style-type: none"> ■ Or > 10 mm 	 Remove plywood	 088236	

PERI Rental Criteria

TRIO



Frame damages	Description	Instruction	Billing Condition	Type
	<p>27.26 Crack in welding</p>		 088243	
	<p>27.27 Crack in the inside welding</p>		 088243	

PERI Rental Criteria

TRIO



TRIO Articulated corner TGE			
No.	Name	Article number	

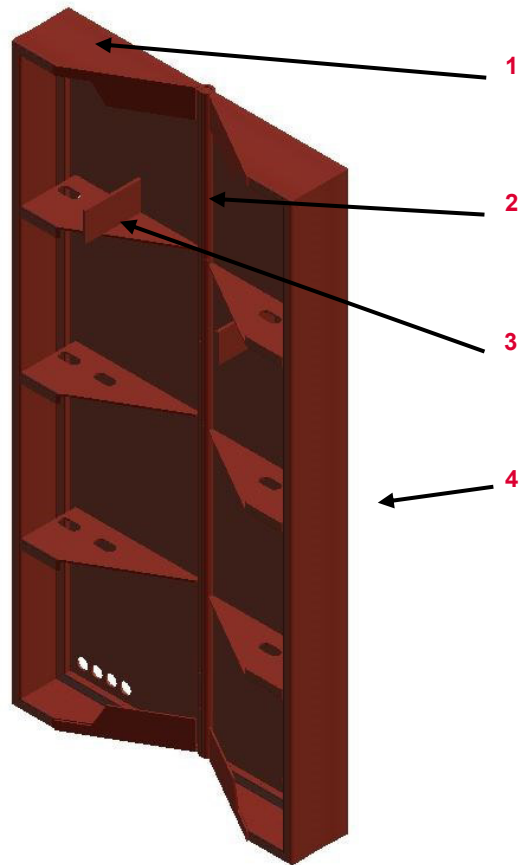

1	Cover plate	722066	
2	Hinge		
3	Metal web	740211	
4	Concrete surface		

Valid for	Article number
Articulated corner TGE/4 330	054414
Articulated corner TGE 270	023200
Articulated corner TGE 120	023300

PERI Rental Criteria

TRIO



TGE	Description	Instruction	Billing Condition	Type
	27.28 Dent or kink in profile or concrete surface <ul style="list-style-type: none"> ■ ≤ 3 mm 			
	<ul style="list-style-type: none"> ■ Or > 3 mm until ≤ 10 mm 			
	<ul style="list-style-type: none"> ■ Or > 10 mm 			

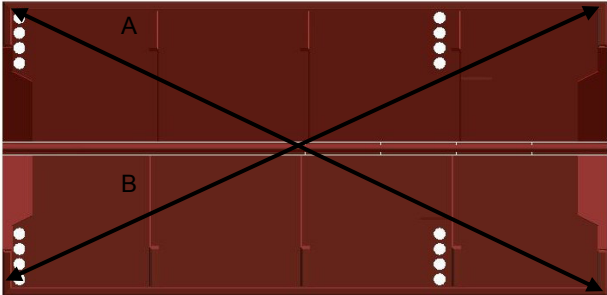

27.29 Frame bent diagonally

- Difference between A and B > 5 mm



PERI Rental Criteria

TRIO



TGE	Description	Instruction	Billing Condition	Type
-----	-------------	-------------	-------------------	------

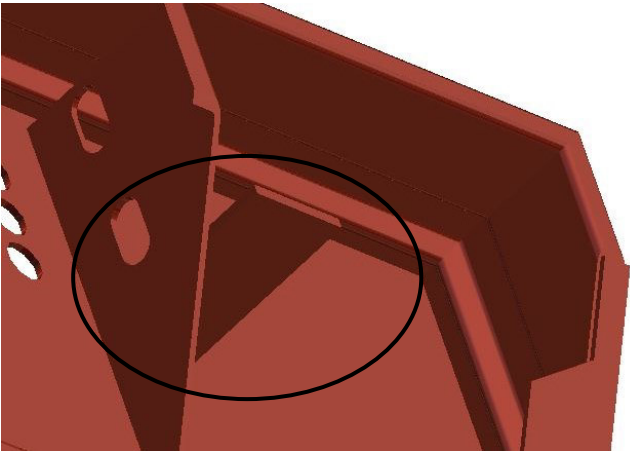

27.30 Bent web



088244

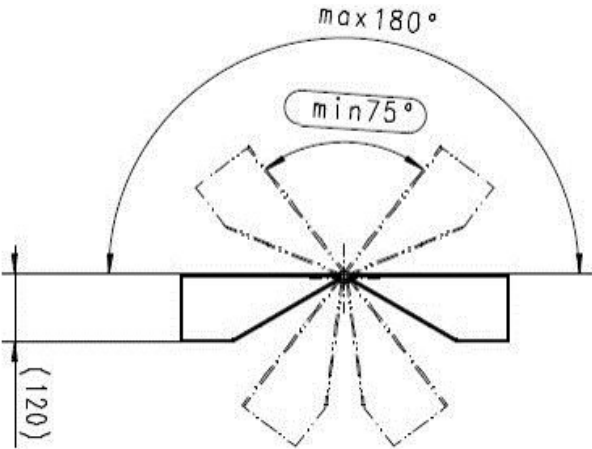

27.31 Function

- Element moves hardly



Afterwards oil the hinge



- Function not available



- Function not available after cleaning and repair



PERI Rental Criteria

TRIO



TRIO Corner elements TE	No.	Name	Article number
-------------------------	-----	------	----------------

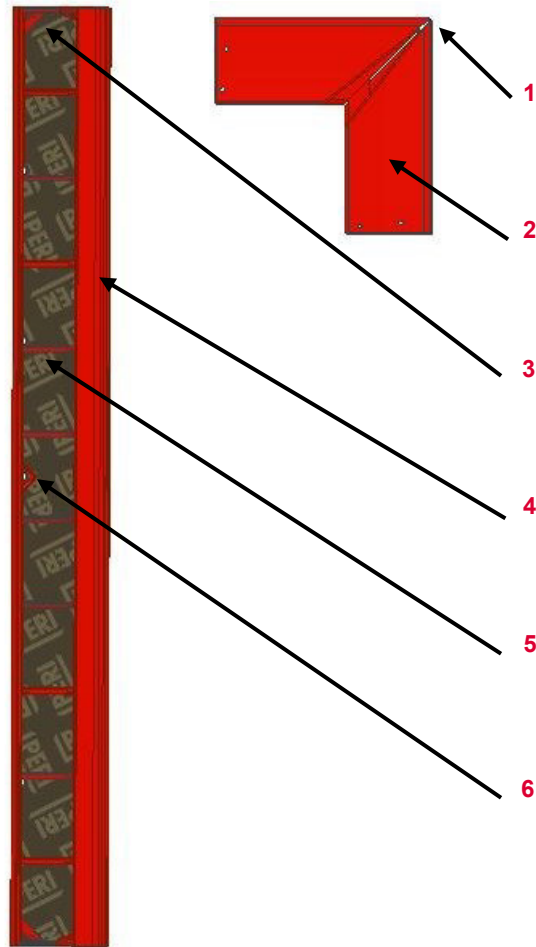

1	Corner strip		
2	Front profile		
3	Bracket	740205	
4	Length profile		
5	Brace		
6	Overlay support	721794	

Valid for	Artikelnummer
Corner element TAE 270-2	023891
Corner element TAE 90-2	023971
Corner element 270-2	022580
Corner element 120-2	022660
Corner element 60-2	022840

PERI Rental Criteria

TRIO



Frame	Description	Instruction	Billing Condition	Type
-------	-------------	-------------	-------------------	------

27.32 Bent element

- > 8 mm

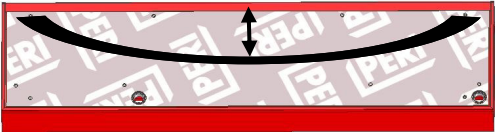

27.33 Bent angle

- > 10 mm

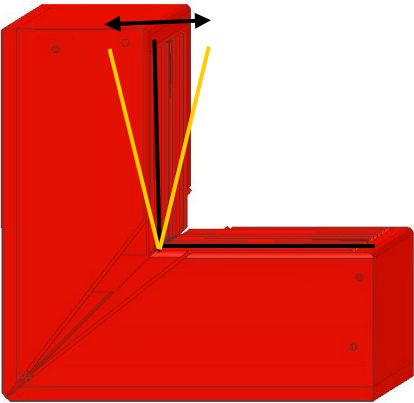

PERI Rental Criteria

TRIO



TRIO Wall thickness compensation steel	No.	Name	Article number
--	-----	------	----------------

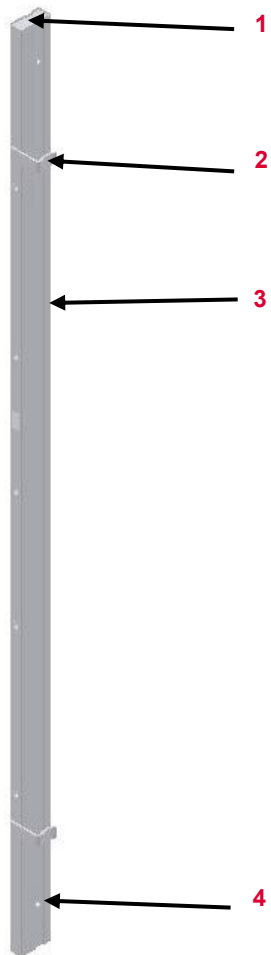

1	Cover plate
2	Profile
3	Concrete surface
4	Sleeve

Valid for	Article number
Wall thickness compensation WDA/4 330x6	054401
Wall thickness compensation WDA/4 330x5	054391
Wall thickness compensation WDA-2 270x6	023192
Wall thickness compensation WDA-2 270x5	023182
Wall thickness compensation WDA-2 120x6	023292
Wall thickness compensation WDA-2 120x5	023282

PERI Rental Criteria

TRIO











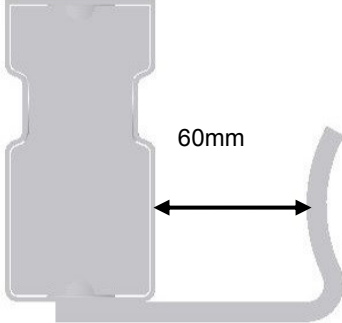

Compensation	Description	Instruction	Billing Condition	Type
	27.34 Bent compensation <ul style="list-style-type: none"> ■ > 8 mm 			
	27.35 Dent in concrete surface <ul style="list-style-type: none"> ■ ≤ 3 mm ■ Or > 3 mm until ≤ 10 mm ■ Or > 10 mm 	<ul style="list-style-type: none">     	<ul style="list-style-type: none">    	<ul style="list-style-type: none">   

PERI Rental Criteria

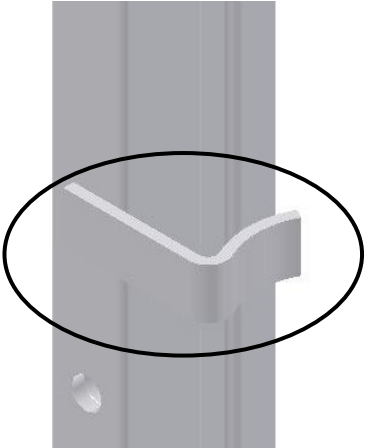
TRIO









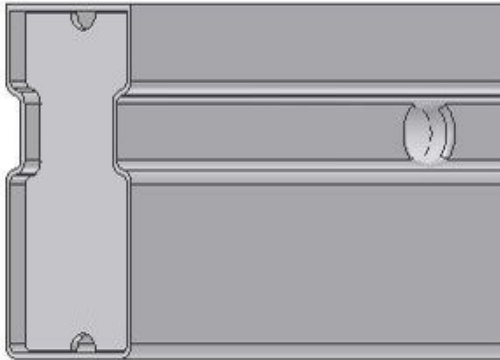

Profile	Description	Instruction	Billing Condition	Type
	27.36 Dented profile <ul style="list-style-type: none"> ■ ≤ 10 mm 		 088244	
	<ul style="list-style-type: none"> ■ Or > 10 mm 		 088164	
	27.37 Profile missing		 088164	

PERI Rental Criteria

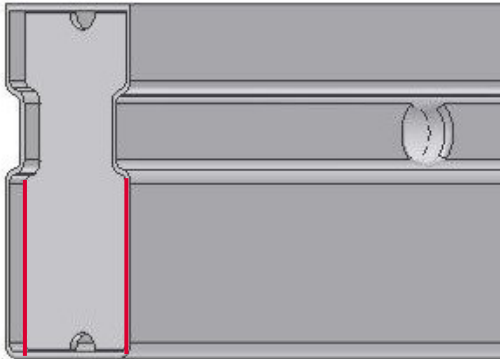
TRIO



Cover plate	Description	Instruction	Billing Condition	Type
	<p>27.38 Deformed cover plate (without damage at the welding)</p>			
	<p>27.39 Deformed cover plate (with damage at the welding)</p>			

PERI Rental Criteria

TRIO



TRIO Wall thickness compensation aluminium	No.	Name	Article number
--	-----	------	----------------

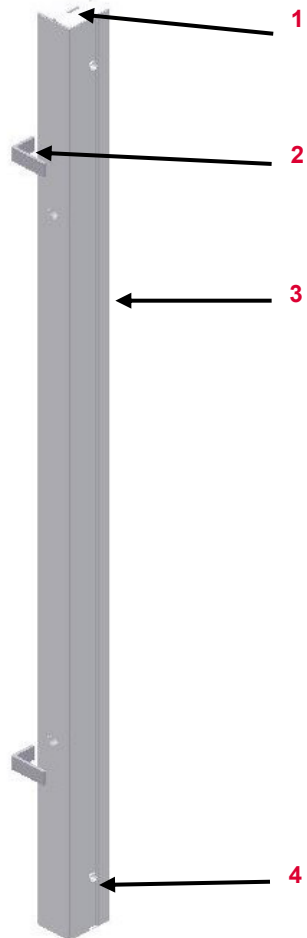











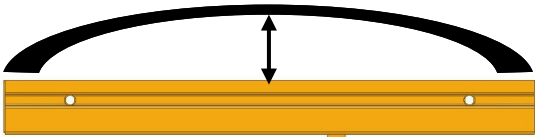



1	Cover plate	101959
2	Profile	
3	Concrete surface	
4	Sleeve	

Valid for	Article number
Wall thickness compensation WDA/4 330x10 Alu	054435
Wall thickness compensation WDA 270x10 Alu	023995
Wall thickness compensation WDA 120x10 Alu	023990

PERI Rental Criteria

TRIO











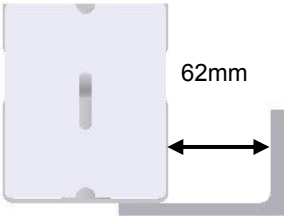

Compensation	Description	Instruction	Billing Condition	Type
	<p>27.40 Bent compensation</p> <ul style="list-style-type: none"> ■ > 8 mm 			
	<p>27.41 Dent in concrete surface</p> <ul style="list-style-type: none"> ■ ≤ 3 mm ■ Or > 3 mm until ≤ 10 mm ■ Or > 10 mm 	<ul style="list-style-type: none">    	<ul style="list-style-type: none">    	<ul style="list-style-type: none">   

PERI Rental Criteria

TRIO











Profile	Description	Instruction	Billing Condition	Type
	<p>27.42 Bent profile</p> <ul style="list-style-type: none"> ■ ≤ 10 mm 		 088244	
	<ul style="list-style-type: none"> ■ Or > 10 mm 	 740781 (WDA 120) 740776 (WDA 270 + 330)	 088000	
	<p>27.43 Profile missing</p>	 740781 (WDA 120) 740776 (WDA 270 + 330)	 088000	

PERI Rental Criteria

TRIO



Cover plate	Description	Instruction	Billing Condition	Type
	<p>27.44 Deformed cover plate (without damage at the welding)</p>			
	<p>27.45 Deformed cover plate (with damage at the welding)</p>		 088001	

PERI Rental Criteria

TRIO



Stop end panel AT	No.	Name	Article number
-------------------	-----	------	----------------

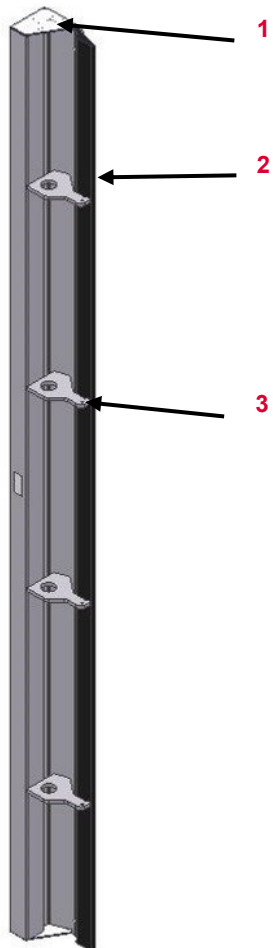









1	Cover plate	100782
2	Sealing profile	
3	Hook	100781

Valid for	Article number
Stop end panel TRIO AT 270x5	105953
Stop end panel TRIO AT 270x3	023060
Stop end panel TRIO AT 120x5	105978
Stop end panel TRIO AT 120x3	023067

PERI Rental Criteria

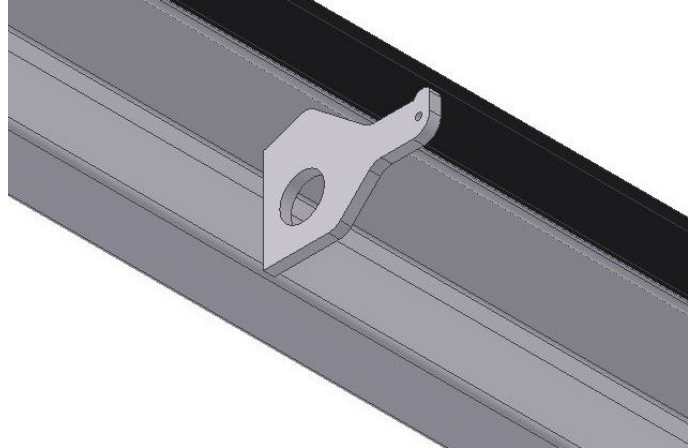
TRIO











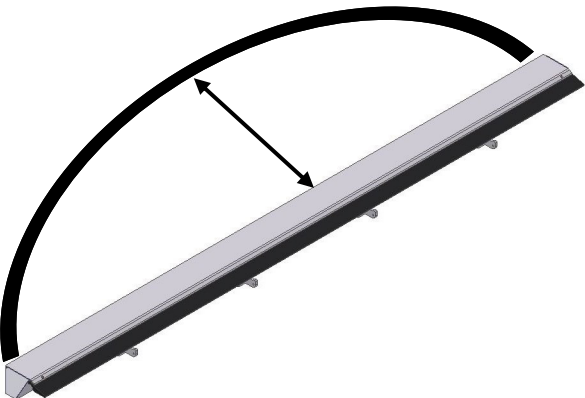

Profile	Description	Instruction	Billing Condition	Type
	<p>27.46 Sealing profile cut , torn</p> <ul style="list-style-type: none"> ■ > 3 mm depth 			
	<p>27.47 Hook broken or missing</p>		 088154	

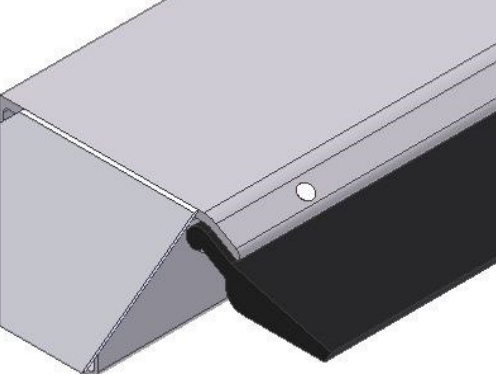
PERI Rental Criteria

TRIO



Profile	Description	Instruction	Billing Condition	Type
	<p>27.48 Bent profile</p> <ul style="list-style-type: none"> ■ > 8 mm 			
	<p>27.49 Damaged cover plate</p> <ul style="list-style-type: none"> ■ > 3 mm until ≤ 10 mm ■ Or > 10 mm 	 	 088244  088151	 

PERI Rental Criteria

TRIO



Stop end panel MT

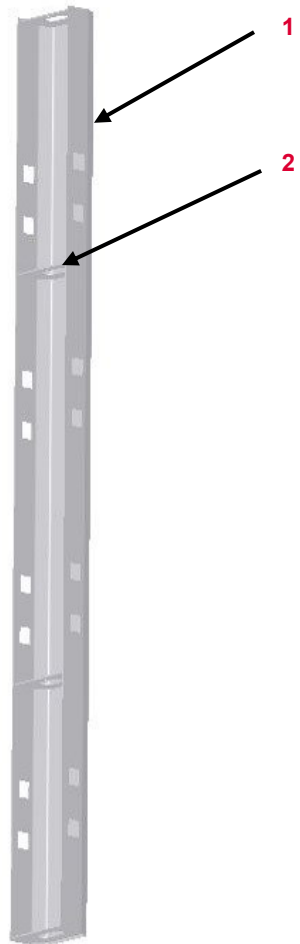









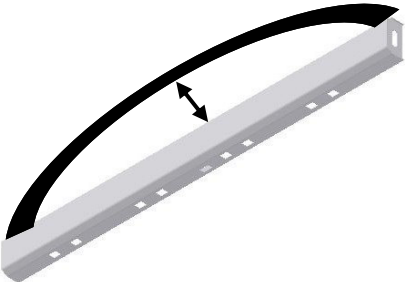

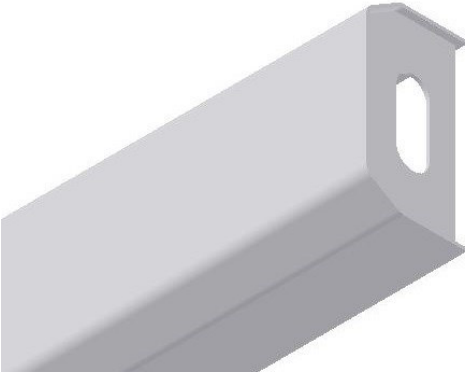

No.	Name	Article number
-----	------	----------------

1	Profile	
2	Cober plate	

Valid for	Article number
-----------	----------------

Stop end panel TRIO MT 270x35/36	023065
Stop end panel TRIO MT 270x30	023064
Stop end panel TRIO MT 270x24/25	023062
Stop end panel TRIO MT 270x20	023061
Stop end panel TRIO MT 120x35/36	023072
Stop end panel TRIO MT 120x30	023071
Stop end panel TRIO MT 120x24/25	023069
Stop end panel TRIO MT 120x20	023068

Stop end panel MT	Description	Instruction	Billing Condition	Type
	<p>27.50 Bent panel</p> <ul style="list-style-type: none"> ■ > 8 mm 			
	<p>27.51 Dented cover plate</p> <ul style="list-style-type: none"> ■ Without damage of the welding ■ Or with damage of the welding 	<ul style="list-style-type: none">    	<ul style="list-style-type: none">  088244  	<ul style="list-style-type: none">  

PERI Rental Criteria

TRIO



Stop end panel MTF	No.	Name	Article number
--------------------	-----	------	----------------

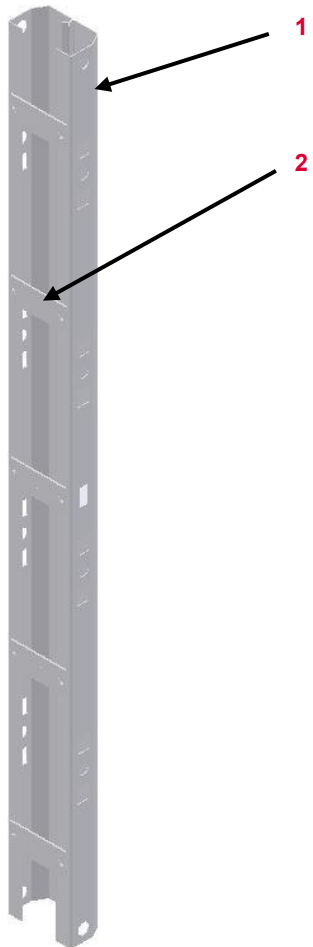







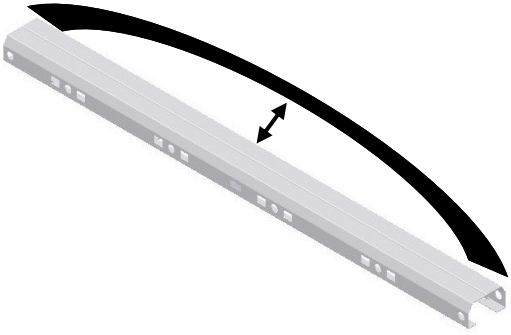

- 1 Profile
- 2 Plate

Valid for	Article number
Stop end panel TRIO MTF 270x35/36	023076
Stop end panel TRIO MTF 270x30	023077
Stop end panel TRIO MTF 270x24/25	023075
Stop end panel TRIO MTF 270x20	023074
Stop end panel TRIO MTF 120x35/36	023079
Stop end panel TRIO MTF 120x30	023078
Stop end panel TRIO MTF 120x24/25	023080
Stop end panel TRIO MTF 120x20	023081

PERI Rental Criteria

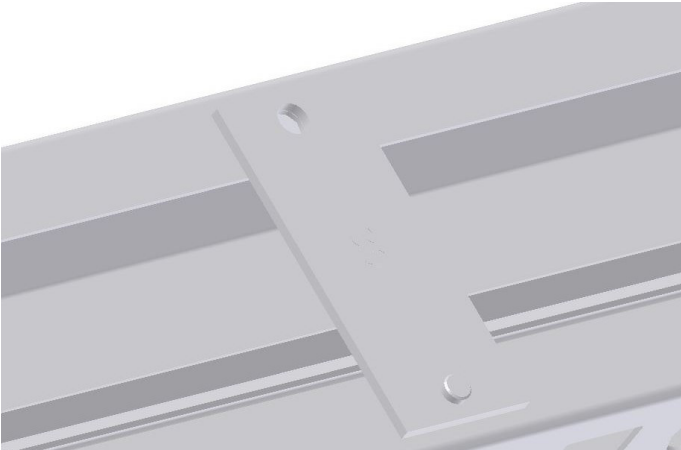
TRIO



Stop end panel MTF	Description	Instruction	Billing Condition	Type
	<p>27.52 Bentprofile</p> <ul style="list-style-type: none"> ■ > 8 mm 			
	<p>27.53 Deformed or missing plate</p>			

PERI Rental Criteria

TRIO



Concrete platform TRIO 120x270 (022950)	No.	Name	Article number
---	-----	------	----------------

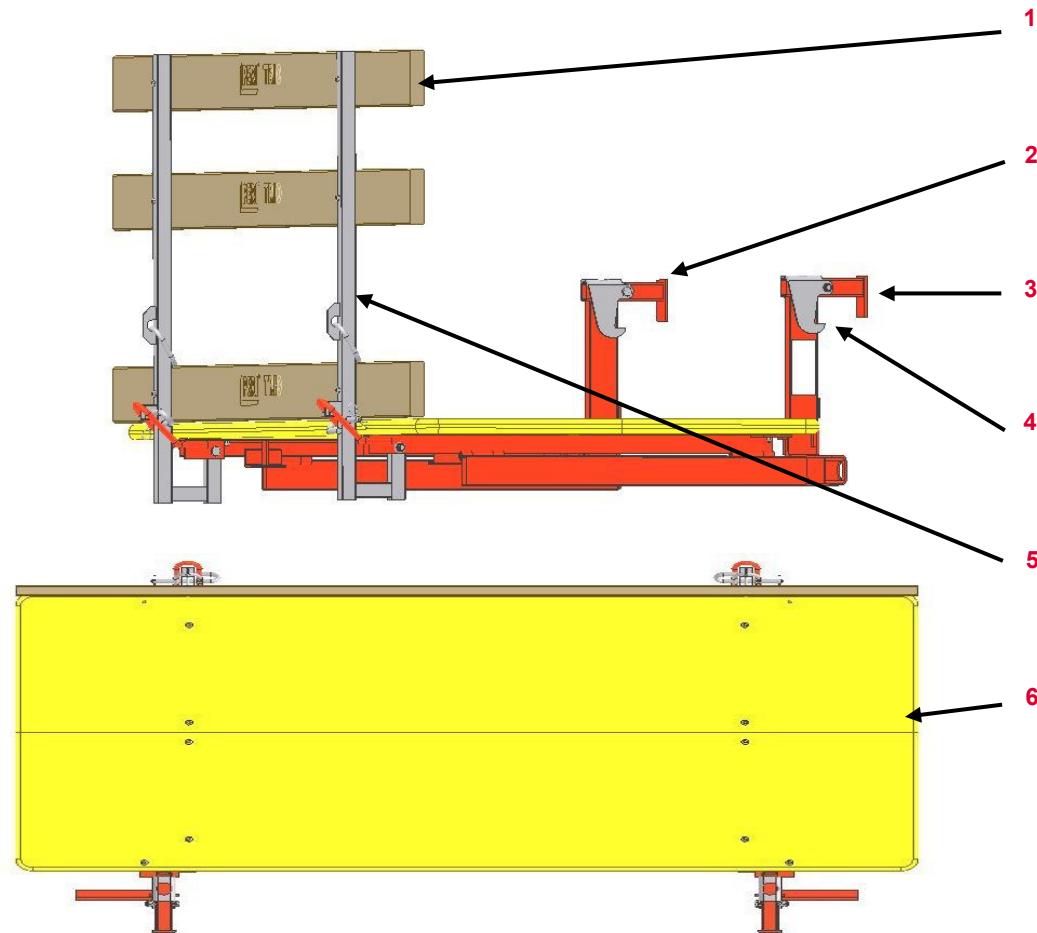

1	TRIO handrail board	022980
2	Platform bracket left	022970
3	Platform bracket	022960
4	Crane eye	721726
5	Handrail post	102623
6	Plywood board	022995

PERI Rental Criteria

TRIO



Concrete platform TRIO	Description	Instruction	Billing Condition	Type
------------------------	-------------	-------------	-------------------	------

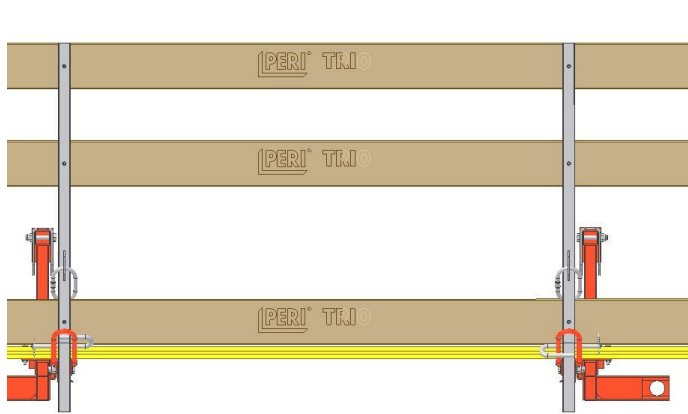

27.54 Damaged or missing handrail board



022980



088215

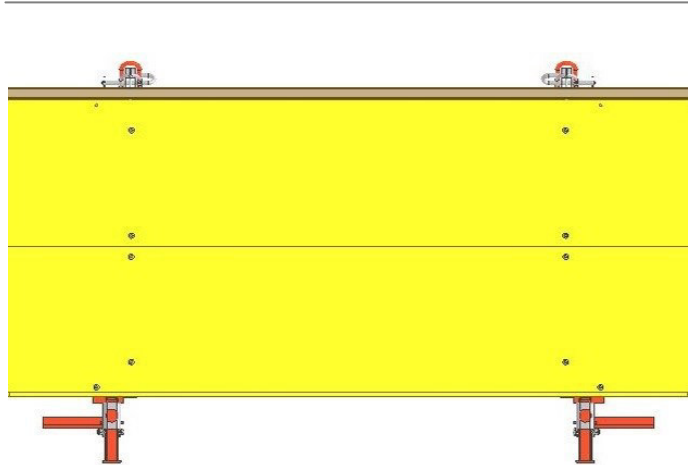

27.55 Plywood plate worn



022995



088214









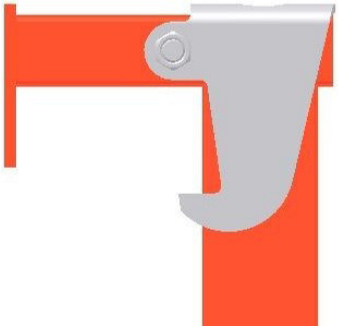

PERI Rental Criteria

TRIO



Concrete platform TRIO	Description	Instruction	Billing Condition	Type
------------------------	-------------	-------------	-------------------	------









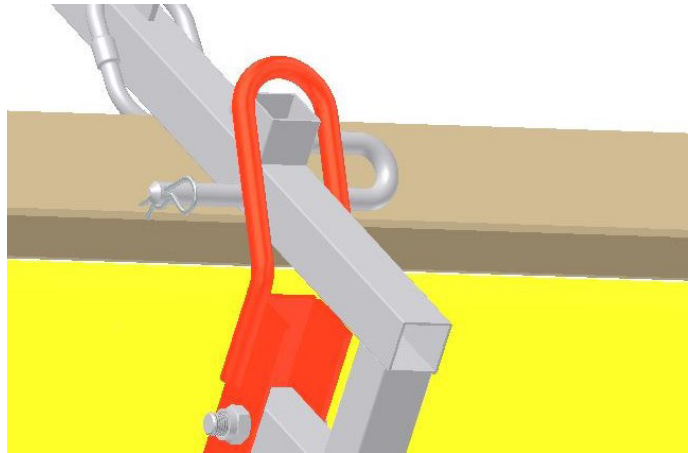

	<p>27.56 Damaged Crane eye</p>	<p> 721726</p>	<p> 088219</p>	<p></p>
---	--------------------------------	---	---	--

	<p>27.57 Damaged, deformed Handrail post</p>	<p> 102623</p>	<p></p>	<p></p>
--	--	--	---	---

PERI Rental Criteria

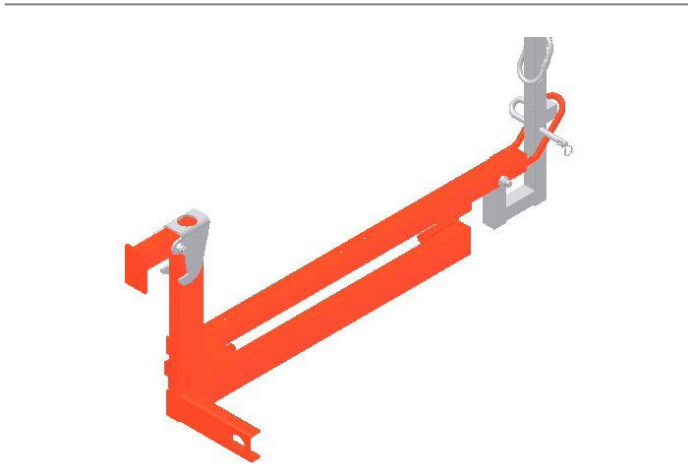
TRIO



Concrete platform TRIO	Description	Instruction	Billing Condition	Type
	<p>27.58 Bracket at the platform bracket</p> <ul style="list-style-type: none"> ■ Crack in welding 	<p> 102621 (concrete platform right) 102622 (concrete platform left)</p>	<p> 088216 088217</p>	
	<ul style="list-style-type: none"> ■ Or deformed 	<p> 102621 (concrete platform right) 102622 (concrete platform left)</p>	<p> 088216 088217</p>	
	<p>27.59 Platform bracket deformed</p>	<p> 102621 (concrete platform right) 102622 (concrete platform left)</p>	<p> 088216 088217</p>	

PERI Rental Criteria

TRIO



Shaft element TSE	No.	Name	Article number
-------------------	-----	------	----------------

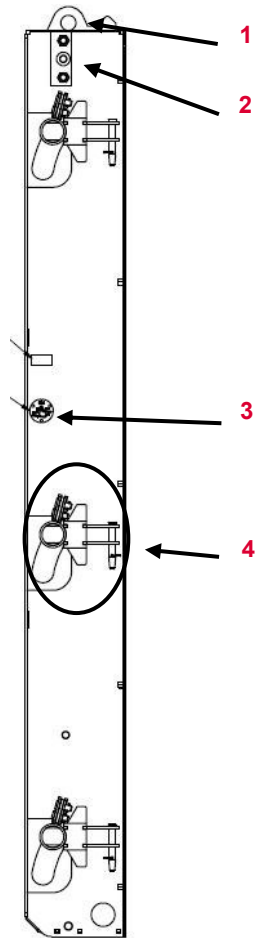











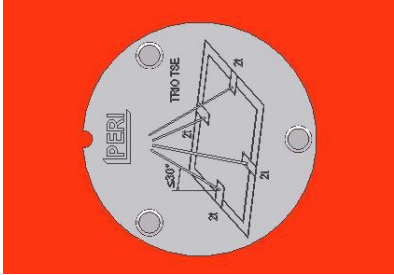



1	Crane eye	108336
2	Reinforcing TSE	113214
3	Information plate	105599
4	Device	

Valid for	Article number
Shaft element TSE 330	105525
Shaft element TSE 270	105523
Shaft element TSE 120	105524

PERI Rental Criteria

TRIO

















Shaft element TSE	Description	Instruction	Billing Condition	Type
	<p>27.60 Information plate is missing</p>	 105599 („Hinweisschild“)		
	<p>27.61 Corner bent by force</p>	 		
	<p>27.62 Device not moveable</p>	 		

PERI Rental Criteria

TRIO



Shaft element TSE	Description	Instruction	Billing Condition	Type
	<p>27.63 Dented or missing crane eye</p>	<p> 108336</p>	<p> 088208</p>	
	<p>27.64 Missing reinforcement</p>	<p></p>	<p></p>	
	<p>27.65 Plates at the devices bent</p> <ul style="list-style-type: none"> ■ If possible ■ Or if not possible 	<p></p> <p></p>	<p> 088244</p> <p> 088197</p>	 

PERI Rental Criteria

TRIO



Filler profile	No.	Name	Article number
----------------	-----	------	----------------

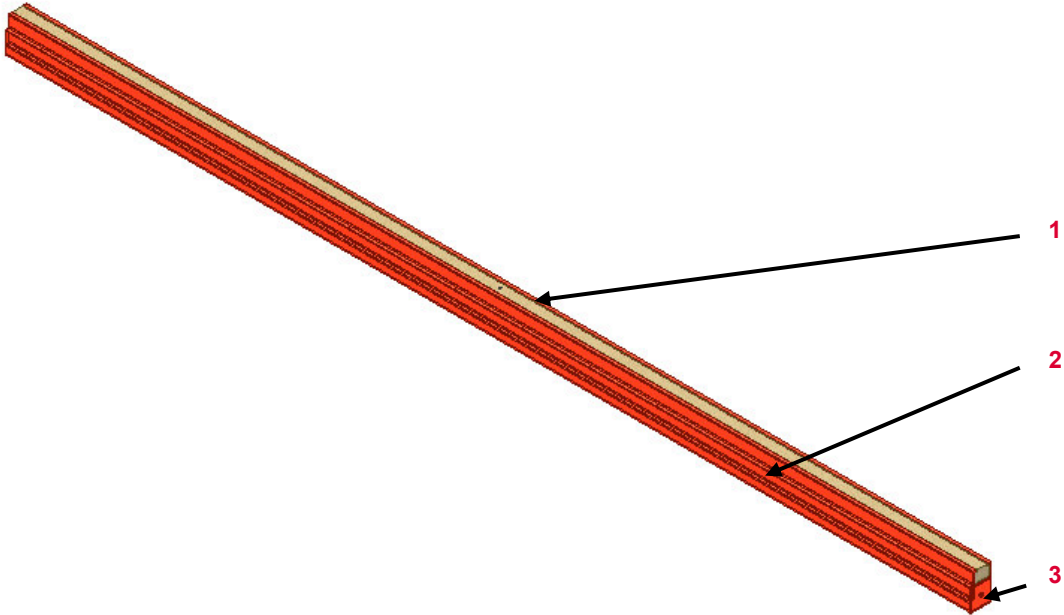

















1	Wood	
2	Profile	
3	Cover plate	115673

Valid for	Article number
Filler profile TPP 120 Alu	101823
Filler profile TPP 270 Alu	101813
Filler profile TPP 330 Alu	101829

PERI Rental Criteria

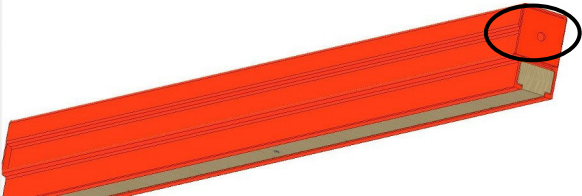
TRIO











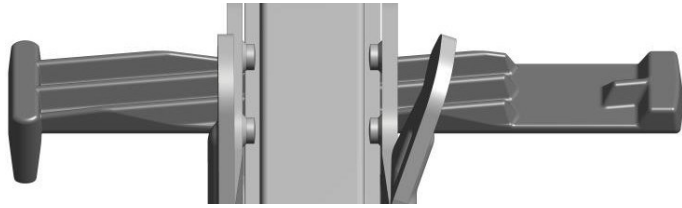





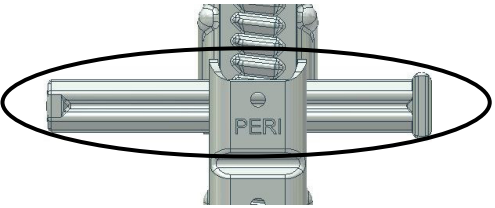

Filler profile	Description	Instruction	Billing Condition	Type
	27.66 Worn wood			
	27.67 Bent profile ■ > 8 mm			
	27.68 Hole in profile ■ > 10 mm	 		
	27.69 Damaged cover plate			

PERI Rental Criteria

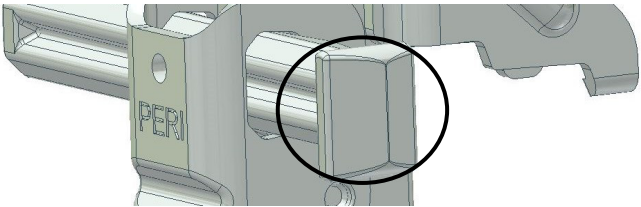
TRIO



Alignment coupler BFD (023500)	Description	Instruction	Billing Condition	Type
	<p>27.70 Tie claw bent</p>		 088244	
	<p>27.71 Coupler fall apart</p>		 088032	
	<p>27.72 Wedge not moveable, crack or bent</p>			
	<p>27.73 Crack in hitting surface</p>			

PERI Rental Criteria

TRIO



TRIO scaffolding bracket TRG	No.	Name	Article number
------------------------------	-----	------	----------------

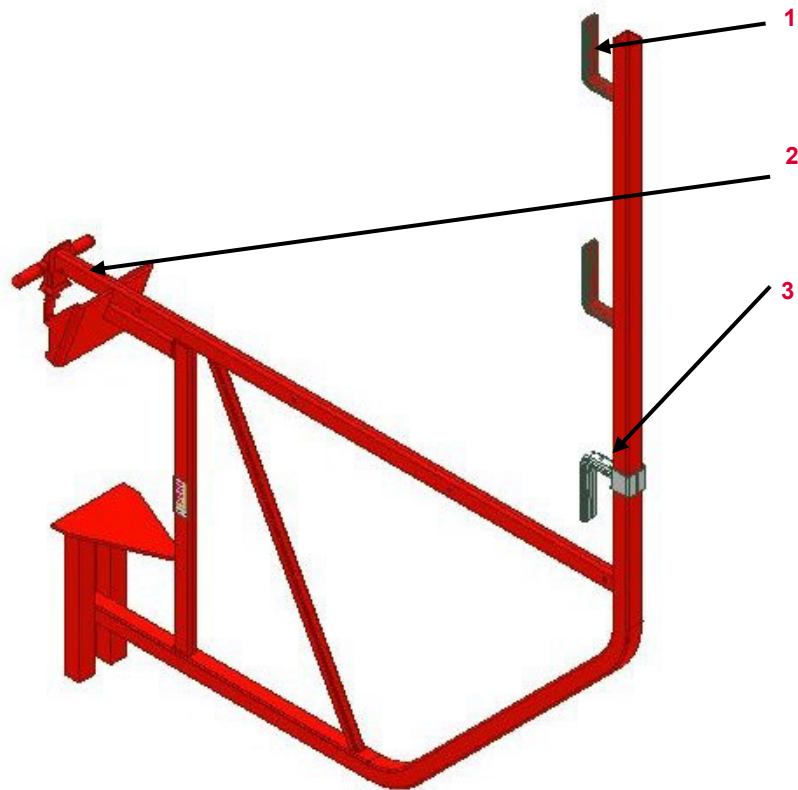

















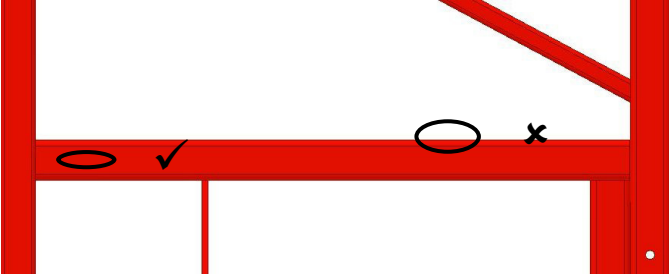

1	Bracket	115543
2	Scaffolding bracket head	
3	Slider	115673

Valid for	Article number
Scaffolding bracket TRG 120	023680
Scaffolding bracket TRG 80	023670

PERI Rental Criteria

TRIO









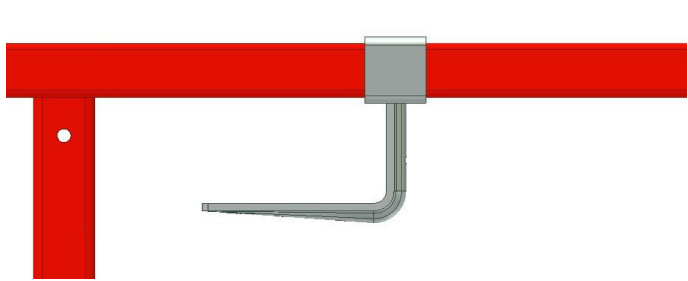

Scaffolding bracket TRG	Description	Instruction	Billing Condition	Type
	27.74 Scaffolding head bent	 		
	27.75 Scaffolding bracket incomplete	 		
	<p>27.76 Dent in the frame</p> <ul style="list-style-type: none"> ■ Dents in frame, edge not affected ■ Dent in the edge of the frame 	<p>  </p> <p>   </p>	<p>  </p> <p>  </p>	<p>  </p> <p>  </p>

PERI Rental Criteria

TRIO



Scaffolding bracket TRG	Description	Instruction	Billing Condition	Type
	27.77 Crack in welding			
	<ul style="list-style-type: none"> <li data-bbox="846 555 1294 651">■ With damage at the frame <li data-bbox="846 651 1294 756">■ Or without damage of the frame 	<div style="display: flex; justify-content: space-around;"> <div data-bbox="1294 555 1375 624"> </div> <div data-bbox="1375 555 1451 624"> </div> </div> <div style="display: flex; justify-content: space-around;"> <div data-bbox="1294 692 1375 761"> </div> <div data-bbox="1375 692 1451 761"> </div> </div>	<div style="display: flex; justify-content: space-around;"> <div data-bbox="1805 555 1877 624"> </div> <div data-bbox="1805 692 1877 761"> </div> </div>	<div style="display: flex; justify-content: space-around;"> <div data-bbox="2078 555 2163 624"> </div> <div data-bbox="2078 692 2163 761"> </div> </div>
	27.78 Slider deformed, missing	<div style="display: flex; align-items: center;">  115673 </div>	<div style="display: flex; align-items: center;">  088184 </div>	
	27.79 Bracket deformed, missing		<div style="display: flex; align-items: center;">  088000 </div>	

PERI Rental Criteria

TRIO



Filler plate LA	No.	Name	Article number
-----------------	-----	------	----------------

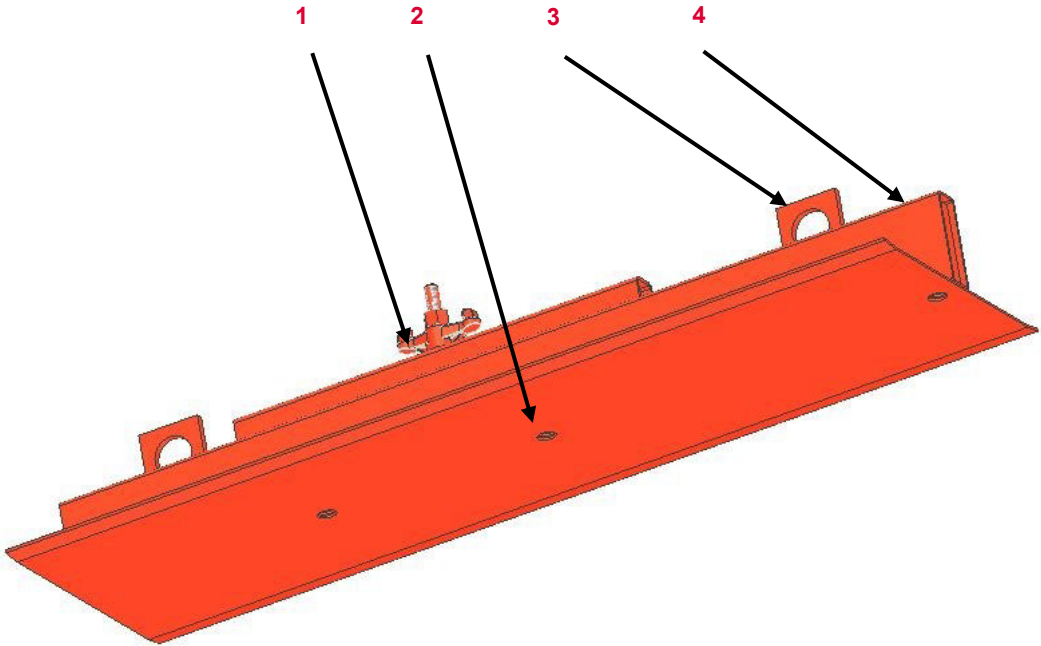











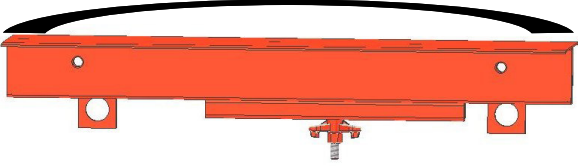



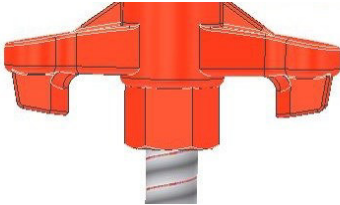

1	Wingnut	030100
2	Concrete surface	
3	Plate	740514
4	Tube	

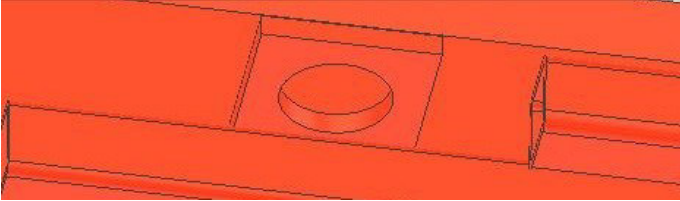
Valid for	Article number
Filler plate LA/4 330x36	054384
Filler plate LA 270x36	023170
Filler plate LA 120x36	023270

PERI Rental Criteria

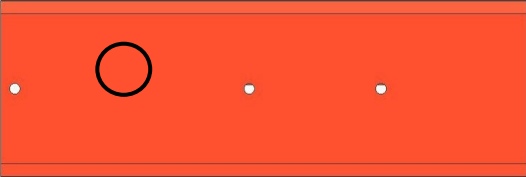
TRIO



Filler plate LA	Description	Instruction	Billing Condition	Type
	<p>Bent profile</p> <ul style="list-style-type: none"> ■ > 8 mm 			
	<p>Wingnut missing, damaged</p>	 030100 (Wingnut)	 088897	
	<p>Crack in plate, deformed</p>		 088153	
	<p>Dent in concrete surface</p>		 088244	

PERI Rental Criteria

TRIO



Waler	No.	Name	Article number
-------	-----	------	----------------

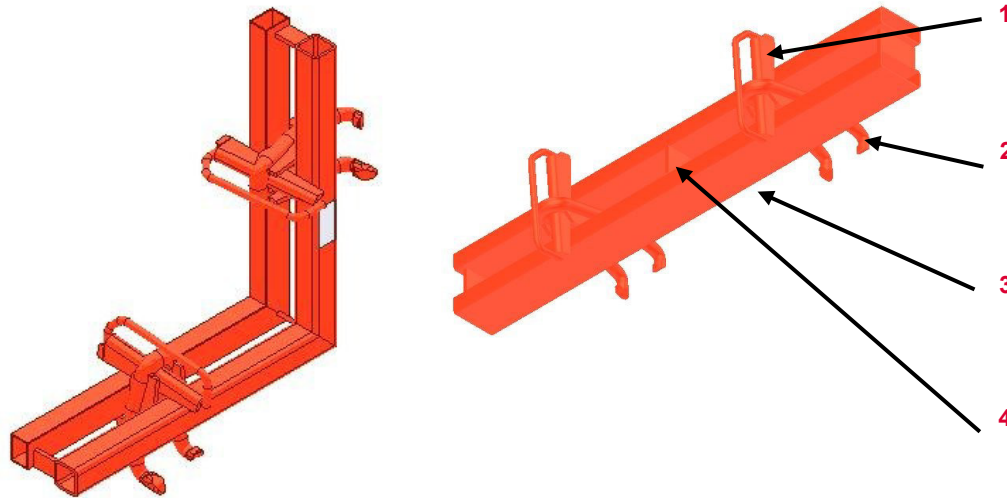

1	Wedge	750585
2	Hook bracket	751543
3	Profile	
4	Profile FI	













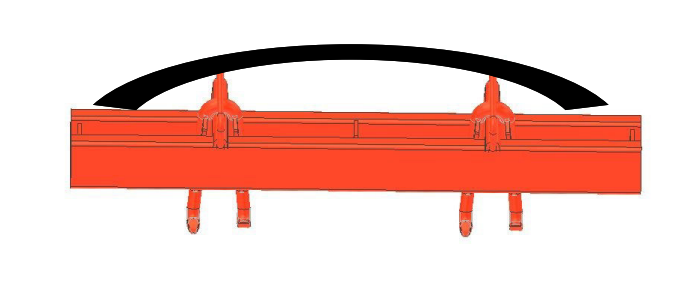

Valid for	Article number
Waler TAR 85	023550
Waler 85	023551
Projection waler TVR 45/45	023560

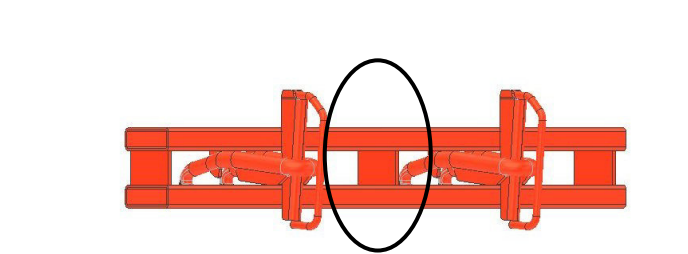

PERI Rental Criteria

TRIO













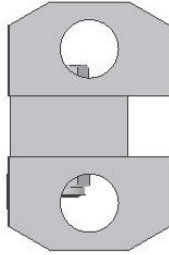

Waler	Description	Instruction	Billing Condition	Type
	<p>27.84 Hook bracket or wedge damaged</p>	<p> 751543 (TVR(751544 (TAR) 750585 (for both)</p>	<p> 088210 088209</p>	
	<p>27.85 Profile bent</p> <ul style="list-style-type: none"> ■ > 5 mm until ≤ 10 mm ■ Or > 10 mm 	<p></p> <p></p>	<p> 088244</p> <p></p>	<p></p> <p></p>
	<p>27.86 Profile fl. missing</p>	<p></p>	<p></p>	

PERI Rental Criteria

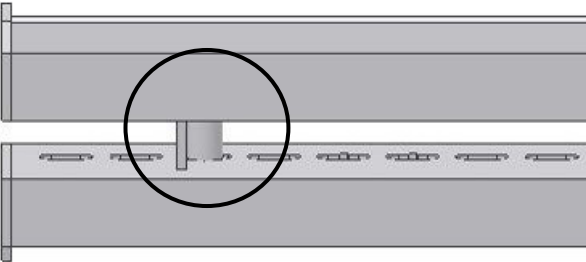
TRIO















Universal waler 245 (023920)	Description	Instruction	Billing Condition	Type
	<p>27.87 Bent</p> <ul style="list-style-type: none"> ■ > 8 mm 			
	<p>27.88 Cover plate bent, missing</p>		 088155	
	<p>27.89 Spacer unit missing</p>	 <ul style="list-style-type: none"> 104178 (spacer unit) 024910 (screw) 781053 (nut) 024180 (washer) 	 088211	

PERI Rental Criteria

TRIO

















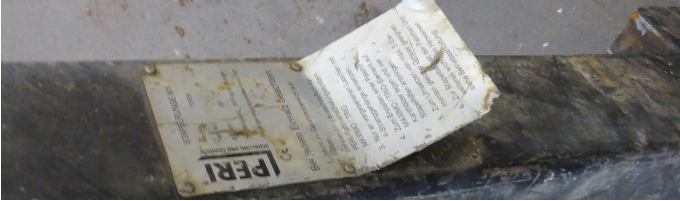

TRIO prop connector (023660)	Description	Instruction	Billing Condition	Type
	<p>27.90 Crack in welding</p>			
	<p>27.91 Damaged, bended</p>		 088244	
	<p>27.92 Broken nut at the wingnut</p>	 030190 (Wingnut)	 088541	

PERI Rental Criteria

TRIO









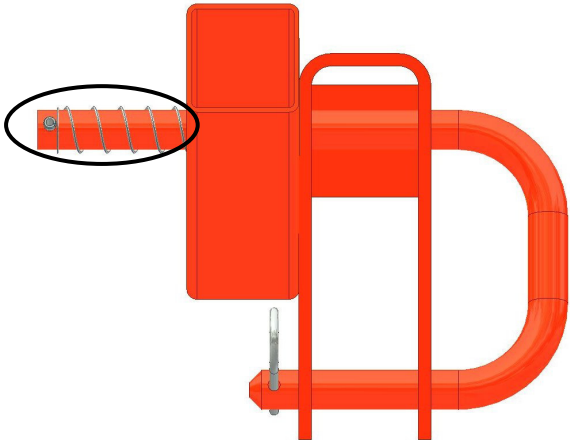

Stacking device MX (115058)	Description	Instruction	Billing Condition	Type
	27.93 Bended profile		 088244	
	27.94 Crack in welding			
	27.95 Unreadable, missing type plate		 088037	
	27.96 Bended device		 088244	

Guardrail post HSGP-2 (116292)	Description	Instruction	Billing Condition	Type
	27.97 Slider deformed, missing	 Schieber (115673)	 088184	
	27.98 Bracket missing, deformed		 088000	
	27.99 Bent, deformed			
	<ul style="list-style-type: none"> ■ > 5 mm 			

PERI Rental Criteria

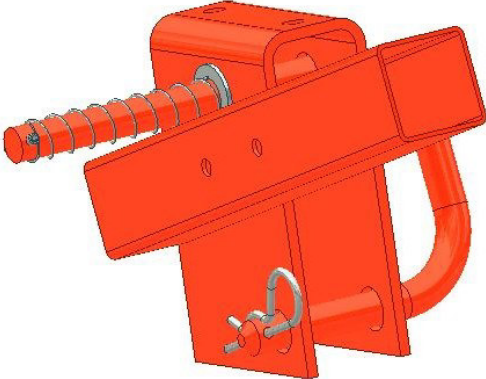
TRIO



Guardrail post holder (101592)	Description	Instruction	Billing Condition	Type
	<p>27.100 Unusable spring</p>	<p> 721816 (Spring)</p>	<p></p>	<p></p>
	<p>27.101 Bent</p>	<p></p>	<p> 088244</p>	<p></p>

PERI Rental Criteria

TRIO



TRIO foundation tie clamp (023010)	Description	Instruction	Billing Condition	Type
------------------------------------	-------------	-------------	-------------------	------

27.102 Brocken nut

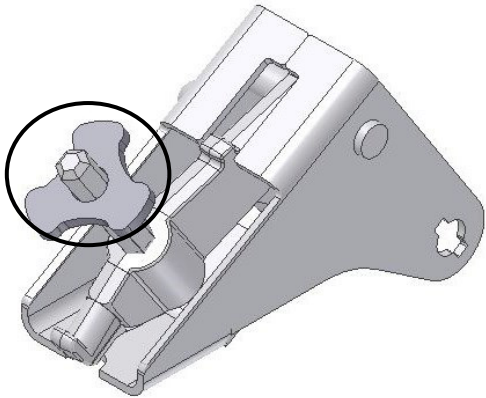

27.103 Plug missing, deformed



722927 (Plug)
722929 (split pin)



















088180



PERI Rental Criteria

Glossary Icons



Icon	Significance	Icon	Significance	Icon	Significance
	Not OK– material is scrap		Billing necessary (customer)		Optical damage
	OK– material stays in rental park		No Billing necessary		Functional damage
	Scrap material– it's not permitted to hand out the material because of safety aspects		Shorten the material		Functional damage— it's not permitted to hand out the material
	Repair according to instruction		Mark the material		Static damage— it's not permitted to hand out the material
	Fix material cold– Afterwards check weld seams and bordering components		Replace damaged material		
	Repair after local economic efficiency calculation		Replace missing material		
	Clean the material				