

PERI Rental Criteria

PEP Props



Contact

PERI GmbH
Formwork Scaffolding
Engineering
 P.O. Box 1264
 89259 Weissenhorn, Germany
 Phone +49 (0) 7309.950-0
 Fax +49 (0) 7309.951-0
rental-criteria@peri.de

Content	Page
PEP Ergo	2
PEP 20, 30	7
Accessories	11
Glossary	23

Changes	Date Initial	Page
New Version	09/2015 fw	

PERI Rental Criteria

PEP Props



PEP ERGO Prop	No.	Name	Article number
---------------	-----	------	----------------

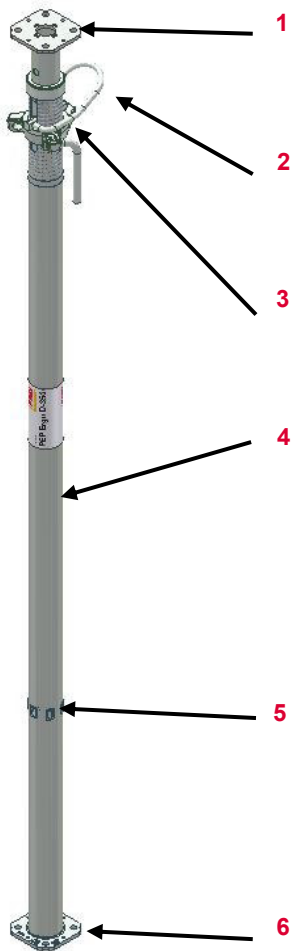











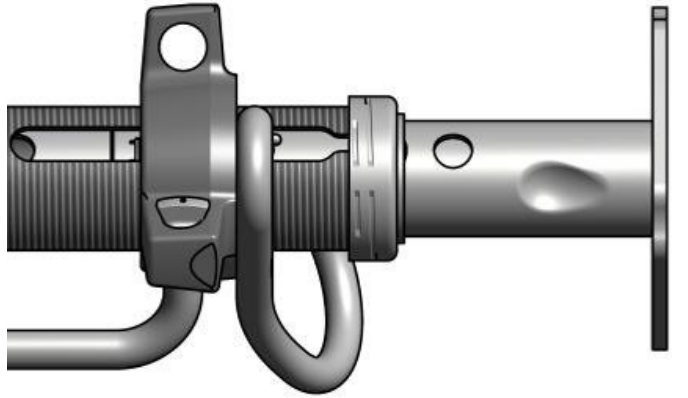

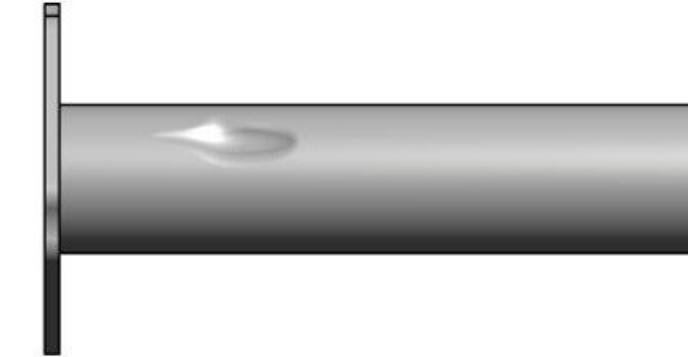

- | | |
|---|---------------|
| 1 | Head plate |
| 2 | G- Hook |
| 3 | Adjusting nut |
| 4 | Outer tube |
| 5 | Stamping |
| 6 | Ground plate |

Valid for	Article number
Prop PEP ERGO B-300	116780
Prop PEP ERGO B-350	116790
Prop PEP ERGO D-150	117230
Prop PEP ERGO D-250	116770
Prop PEP ERGO D-350	125130
Prop PEP ERGO D-400	125140
Prop PEP ERGO D-500	125150
Prop PEP ERGO E-300	125160
Prop PEP ERGO E-400	125170

PERI Rental Criteria

PEP Props



Prop	Description	Instruction	Billing Condition	Type
	20.07.01 Bent inner tube		 See table (p. 4)	
	<ul style="list-style-type: none"> ■ Inner tube not moveable 		 See table (p. 4)	
	20.07.02 Bent outer tube		 See table (p. 4)	
	<ul style="list-style-type: none"> ■ Inner tube not moveable 		 See table (p. 4)	
<ul style="list-style-type: none"> ■ Or depth of bent > 7 mm 		 See table (p. 4)		

PERI Rental Criteria

PEP Props



Article	Replace inner tube		Replace outer tube	
	Art.– No. Spare part	Service article number	Art.– No. Spare part	Service article number
PEP ERGO B-300	116786	088719	116788	088710
PEP ERGO B-350	116794	088720	116769	088711
PEP ERGO D-150	117226	088721	117228	088712
PEP ERGO D-250	116778	088722	116789	088713
PEP ERGO D-350	125543	088723	125546	088714
PEP ERGO D-400	125562	088724	125565	088715
PEP ERGO D-500	125581	088725	125584	088716
PEP ERGO E-300	125588	088726	125591	088717
PEP ERGO E-400	125595	088727	125598	088718

PERI Rental Criteria

PEP Props



















Damage Prop	Description	Instruction	Billing Condition	Type
	20.07.03 Ground or head plate bent <ul style="list-style-type: none"> ■ > 10 mm 		088249	
	20.07.04 Adjusting nut <ul style="list-style-type: none"> ■ Nut torn out 		088235	
	<ul style="list-style-type: none"> ■ Or crack in adjusting nut 		088235	
	20.07.05 G- Hook <ul style="list-style-type: none"> ■ Missing 		088247	
	<ul style="list-style-type: none"> ■ Or function not available 		088247	

PERI Rental Criteria

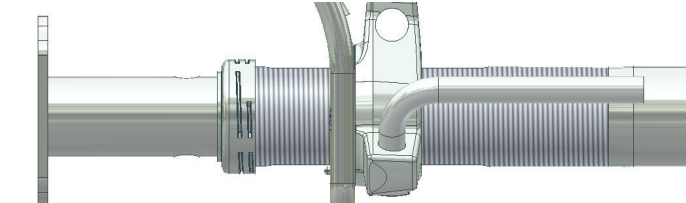
PEP Props



Prop	Description	Instruction	Billing Condition	Type
	<p>20.07.06 Crack in the welding</p>			
	<p>20.07.07 Stop screw loose/ missing</p>			
	<p>20.07.08 Tube of the props heated</p>			
	<p>20.07.09 Oil or grease at the thread</p>			

PERI Rental Criteria

PEP Props



PEP 20, 30 Props	No.	Name	Article number
------------------	-----	------	----------------

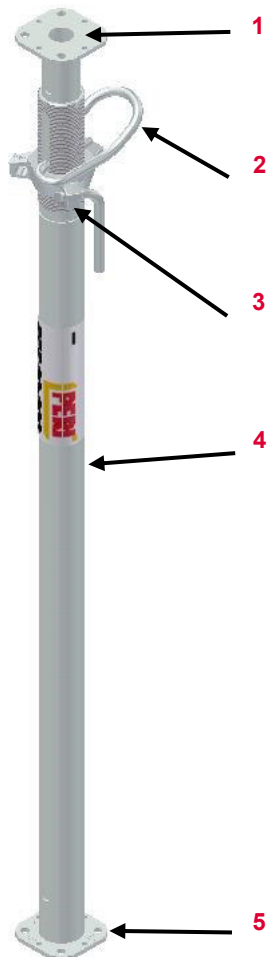









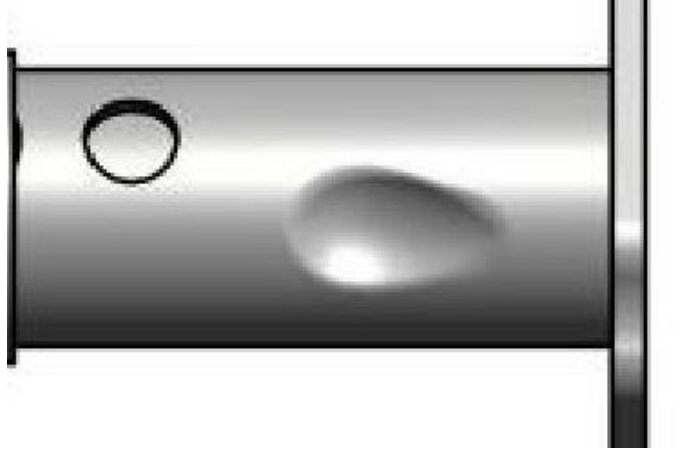

- | | |
|---|---------------|
| 1 | Head plate |
| 2 | G- Hook |
| 3 | Adjusting nut |
| 4 | Outer tube |
| 5 | Ground plate |

Valid for	Article number
Prop PEP 20-300	103058
Prop PEP 20-350	103059
Prop PEP 20-400	103060
Prop PEP 20-500	103061
Prop PEP 30-150	103066
Prop PEP 30-250	103067
Prop PEP 30-300	103062
Prop PEP 30-350	103063
Prop PEP 30-400	103065

PERI Rental Criteria

PEP Props











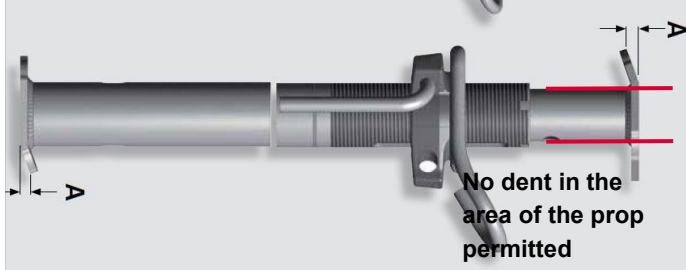









Prop	Description	Instruction	Billing Condition	Type
	<p>20.07.10 Dent at the inner tube</p> <ul style="list-style-type: none"> Inner tube not moveable 			
	<p>20.07.11 Bent outer tube, inner tube not moveable</p> <ul style="list-style-type: none"> Distance to ground plate ≤ 50 cm Or distance to ground plate > 50 cm 	 	 088249 	 

PERI Rental Criteria

PEP Props















Prop	Description	Instruction	Billing Condition	Type
	<p>20.07.12 Ground or head plate bent</p> <ul style="list-style-type: none"> ■ > 10 mm 		 088249	
	<p>20.07.13 Adjusting nut</p> <ul style="list-style-type: none"> ■ Nut torn out ■ Or crack in adjusting nut 	 	 	 
	<p>20.07.14 G- Hook</p> <ul style="list-style-type: none"> ■ Missing ■ Or function not available 	 	 088247  088247	 

PERI Rental Criteria

PEP Props











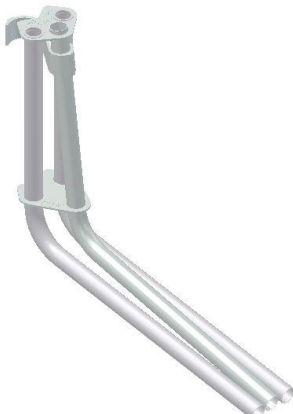





Prop	Description	Instruction	Billing Condition	Type
	<p>20.07.15 Crack in welding</p>			
	<p>20.07.16 Tube of the prop heated</p>			
	<p>20.07.17 Oil or grease at the thread</p>			

PERI Rental Criteria

PEP Props



Tripod PEP Ergo (107152)	Description	Instruction	Billing Condition	Type
	20.07.18 Legs bent			
	<ul style="list-style-type: none"> ■ ≤ 10 mm 		 088244	
	<ul style="list-style-type: none"> ■ > 10 mm 	 		
<p>Nominal dimension 70mm</p> 	20.07.19 Bent spanner			
	<ul style="list-style-type: none"> ■ ≤ 3 mm bent 			
	<ul style="list-style-type: none"> ■ > 3 mm bent 		 088244	

PERI Rental Criteria

PEP Props



Universal tripod (028000)	No.	Name	Article number
---------------------------	-----	------	----------------

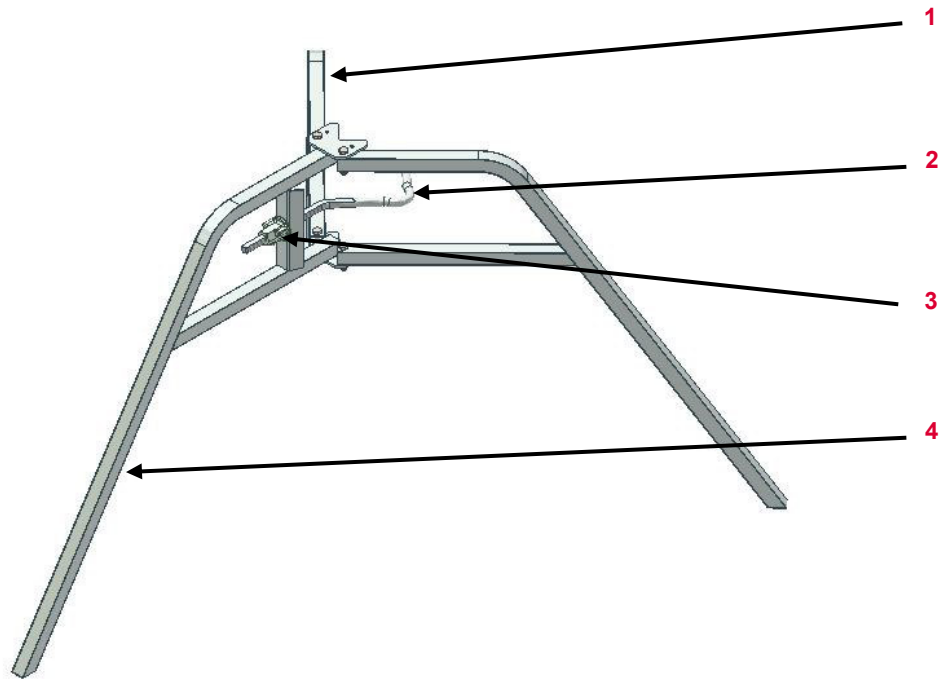













1	Pivoting arm	715643
2	Tension hoop	710161
3	Cam nut	030130
4	Support leg	715642

PERI Rental Criteria

PEP Props











Universal tripod	Description	Instruction	Billing Condition	Type
	20.07.20 Pivoting arm	<ul style="list-style-type: none"> <li data-bbox="878 566 1012 598">■ If possible  	 088244 	
	<ul style="list-style-type: none"> <li data-bbox="878 710 1086 742">■ Or if not possible 		 	
	20.07.21 Support leg	<ul style="list-style-type: none"> <li data-bbox="878 1069 1012 1101">■ If possible  	 088244 	
	<ul style="list-style-type: none"> <li data-bbox="878 1212 1086 1244">■ Or if not possible 		 	

PERI Rental Criteria

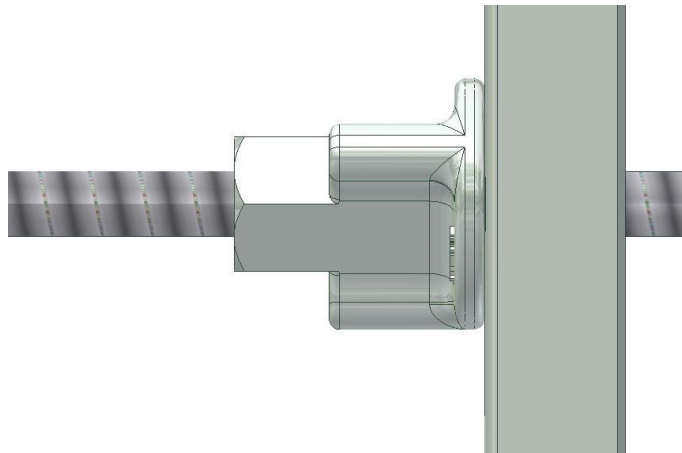
PEP Props



Universal tripod	Description	Instruction	Billing Condition	Type
	<p>20.07.22 Tension hoop bent</p> <ul style="list-style-type: none"> ■ > 100° 			
	<p>20.07.23 Nut at the cam nut torn</p>	 <p>030130 (cam nut) 767043 (grooved pin)</p>	 <p>088429</p>	

PERI Rental Criteria

PEP Props



PEP Frame PRK	No.	Name	Article number
---------------	-----	------	----------------

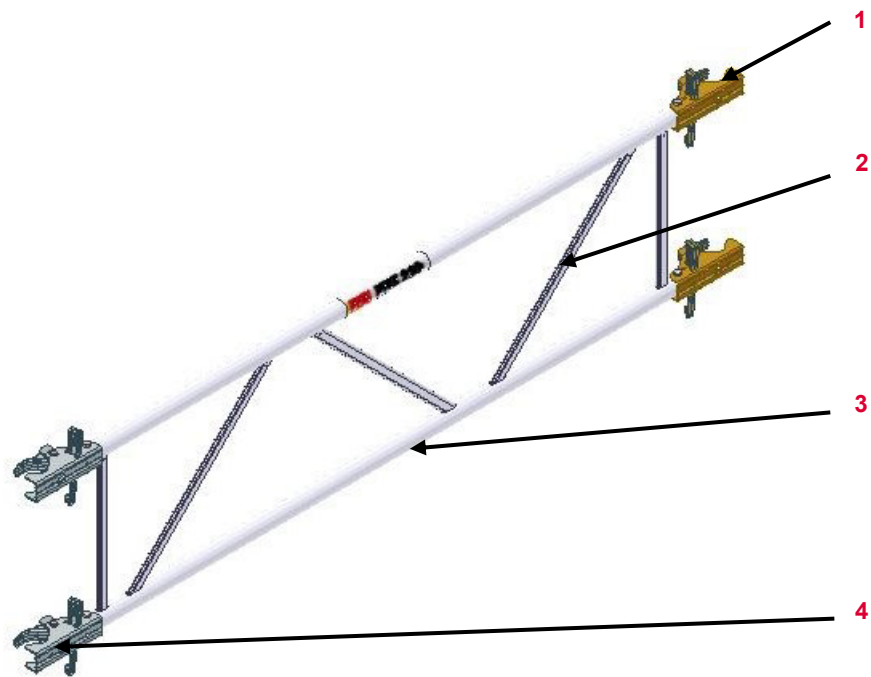

1	Connector PRK left	112210
2	Brace	
3	Frame	
4	Connector PRK right	112206

Valid for	Article number
Frame PRK 62,5	111811
Frame PRK 75	111812
Frame PRK 100	112813
Frame PRK 120	112814
Frame PRK 137,5	111815
Frame PRK 150	111814
Frame PRK 180	115980
Frame PRK 200	112718
Frame PRK 201,5	111815
Frame PRK 210	112788
Frame PRK 225	111816
Frame PRK 230	111817
Frame PRK 266	111818
Frame PRK 296	111819

PERI Rental Criteria

PEP Props



PEP Frame PRK	Description	Instruction	Billing Condition	Type
---------------	-------------	-------------	-------------------	------

20.07.24 Bent frame



■ ≤ permitted bent



■ Or > permitted bent



Article	Perm. bent
PRK 62,5	2,5 mm
PRK 75	3,0 mm
PRK 100	4,0 mm
PRK 120	4,8 mm
PRK 137,5	5,5 mm
PRK 150	6,0 mm
PRK 180	7,2 mm
PRK 200	8,0 mm
PRK 201,5	8,0 mm
PRK 210	8,4 mm
PRK 225	9,0 mm
PRK 230	9,2 mm
PRK 266	10,5 mm
PRK 296	11,8 mm

PERI Rental Criteria

PEP Props



PEP Frame PRK	Description	Instruction	Billing Condition	Type
---------------	-------------	-------------	-------------------	------

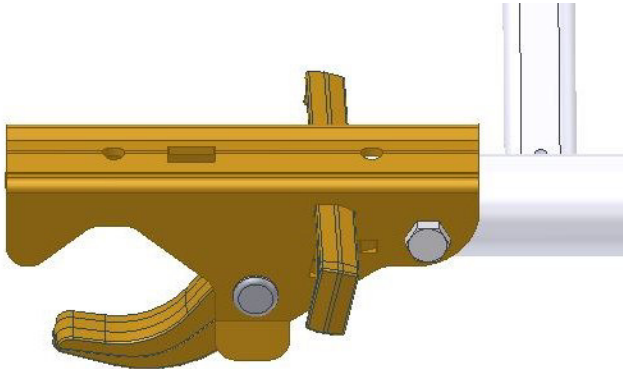

**20.07.25 Connector left/ right
useless/ deformed**



112210 (Connector left)
112206 (Connector right)



088246



















**20.07.26 Crack in welding at the
brace**

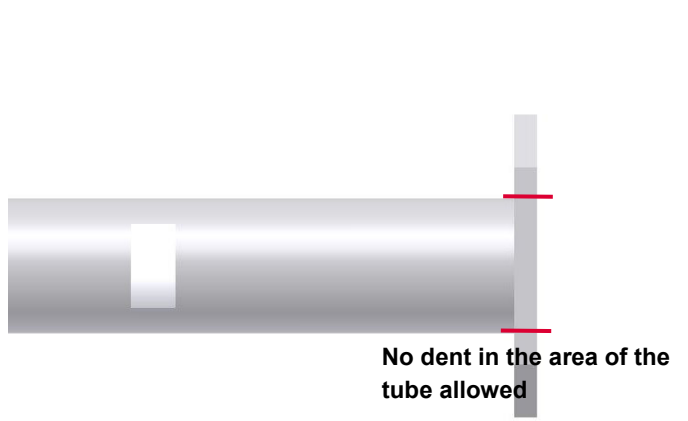

PERI Rental Criteria

PEP Props





Feet MP 50 (027310)	Description	Instruction	Billing Condition	Type
	<p>20.07.27 Dent in tube</p> <ul style="list-style-type: none"> ■ ≤ 6 mm depth and ≤ Ø 60 mm ■ Or > 6 mm depth ■ Or > Ø 60 mm 	<ul style="list-style-type: none">    	<ul style="list-style-type: none">    	<ul style="list-style-type: none">   
 <p>No dent in the area of the tube allowed</p>	<p>20.07.28 Head or ground plate bent</p> <ul style="list-style-type: none"> ■ ≤ 15 mm ■ Or > 15 mm 	<ul style="list-style-type: none">   	<ul style="list-style-type: none">  088244  	<ul style="list-style-type: none">  

PERI Rental Criteria

PEP Props











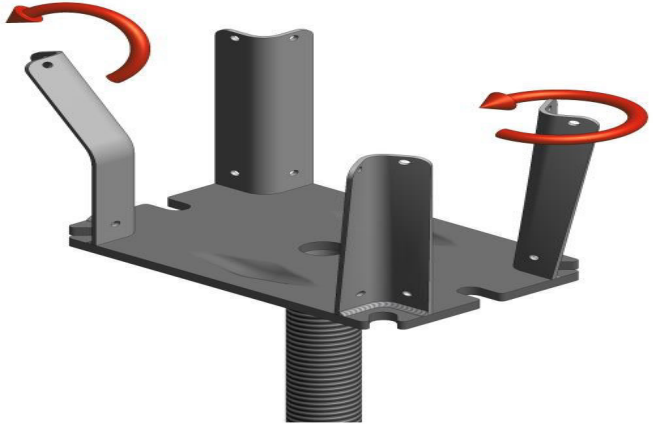





Feet MP 50 (027310)	Description	Instruction	Billing Condition	Type
	<p>20.07.29 Spring tube missing damaged</p> <ul style="list-style-type: none"> Spring tube first version (black) Spring tube second version (orange) 	<p>Wrench icon</p> <p>Wrench icon</p>	<p>Spring tube with slash icon</p> <p>088367</p> <p>Spring tube icon</p>	<p>Green gear icon</p> <p>Green gear icon</p>
	<p>20.07.30 Tension claw missing or damaged</p>	<p>Hex nut icon</p> <p>780108 (spring tube) 780105 (tension claw) 710381 (nut) 780702 (washer 2x)</p>	<p>Spring tube icon</p>	<p>Green gear icon</p>
	<p>20.07.31 Tension claw not tightened</p> <ul style="list-style-type: none"> Tension claw should have some resistance when moved by hand 	<p>Wrench icon</p>	<p>Spring tube with slash icon</p>	<p>Green gear icon</p>

PERI Rental Criteria

PEP Props











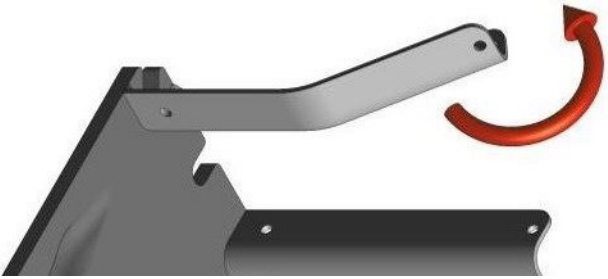







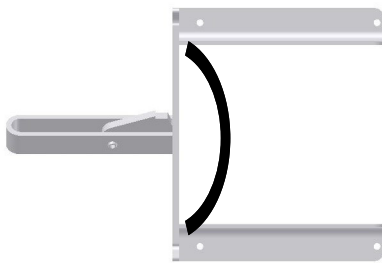

Crosshead 20/24 (027890)	Description	Instruction	Billing Condition	Type
	20.07.32 Plaid			
	<ul style="list-style-type: none"> ■ Bent (without damaged welding) 		 088395	
	<ul style="list-style-type: none"> ■ Or bent (with damaged welding) 		 088394	
<ul style="list-style-type: none"> ■ Or missing 		 088394		
	20.07.33 Base plate			
<ul style="list-style-type: none"> ■ > 5 mm 				

PERI Rental Criteria

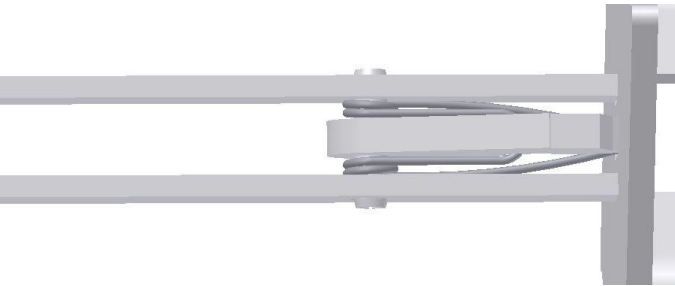
PEP Props



Crosshead 20/24S (028680)	Description	Instruction	Billing Condition	Type
	<p>20.07.34 Plaid</p> <ul style="list-style-type: none"> ■ Bent (without crack in welding) ■ Or bent (with crack in welding) ■ Or missing 	  	 088395  088394  088394	  
	<p>20.07.35 Bent base plate</p> <ul style="list-style-type: none"> ■ > 5 mm 	 		
	<p>20.07.36 Safety hatch</p>		 088898	

PERI Rental Criteria

PEP Props



Brace clamp (027940; 027790)	No.	Name	Article number
------------------------------	-----	------	----------------

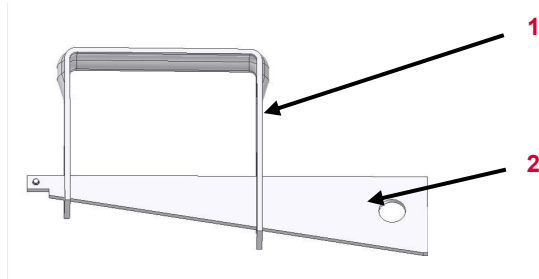

- 1 Bracket
- 2 Wedge

Damage	Description	Instruction	Billing Condition	Type
--------	-------------	-------------	-------------------	------

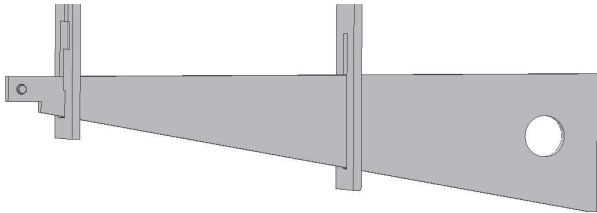

20.07.37 Wedge missing

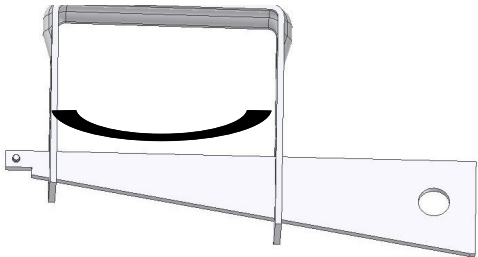

20.07.38 Bracket bent



















088244



PERI Rental Criteria

Glossary Icons



Icon	Bedeutung	Icon	Bedeutung	Icon	Bedeutung
	Not Ok– material is scrap		Billing necessary (customer)		Optical damage
	OK– material stays in rental park		No Billing necessary		Functional damage
	Scrap material– it's not permitted to hand out the material because of safety aspects		Shorten the material		Functional damage– it's not permitted to hand out the material
	Repair according to instruction		Mark the material		Static damage– it's not permitted to hand out the material
	Fix part cold– Afterwards check the weld seam and bordering components		Replace damaged material		
	Repair after local economic efficiency calculation		Replace missing material		
	Clean the material				