

# PERI Rental Criteria

## PD 8 System



### Contact

**PERI GmbH**  
**Formwork Scaffolding**  
**Engineering**  
 P.O. Box 1264  
 89264 Weissenhorn, Germany  
 Phone +49 (0) 7309.950-0  
 Fax +49 (0) 7309.951-0  
 rental-criteria@peri.de

Content	Page
Frame	2
Diagonal Brace	13
Load tower brace	17
Accessories	19
Trolley with Winch	29
Castor	35
PD 8 Lift Unit Lower Part	36
Stair	37
Glossary	38

Changes made	Date   Initial	Page
Neuerstellung	05/2016   fw	

# PERI Rental Criteria

## PD 8 System



Frame	No.	Name	Article number
-------	-----	------	----------------

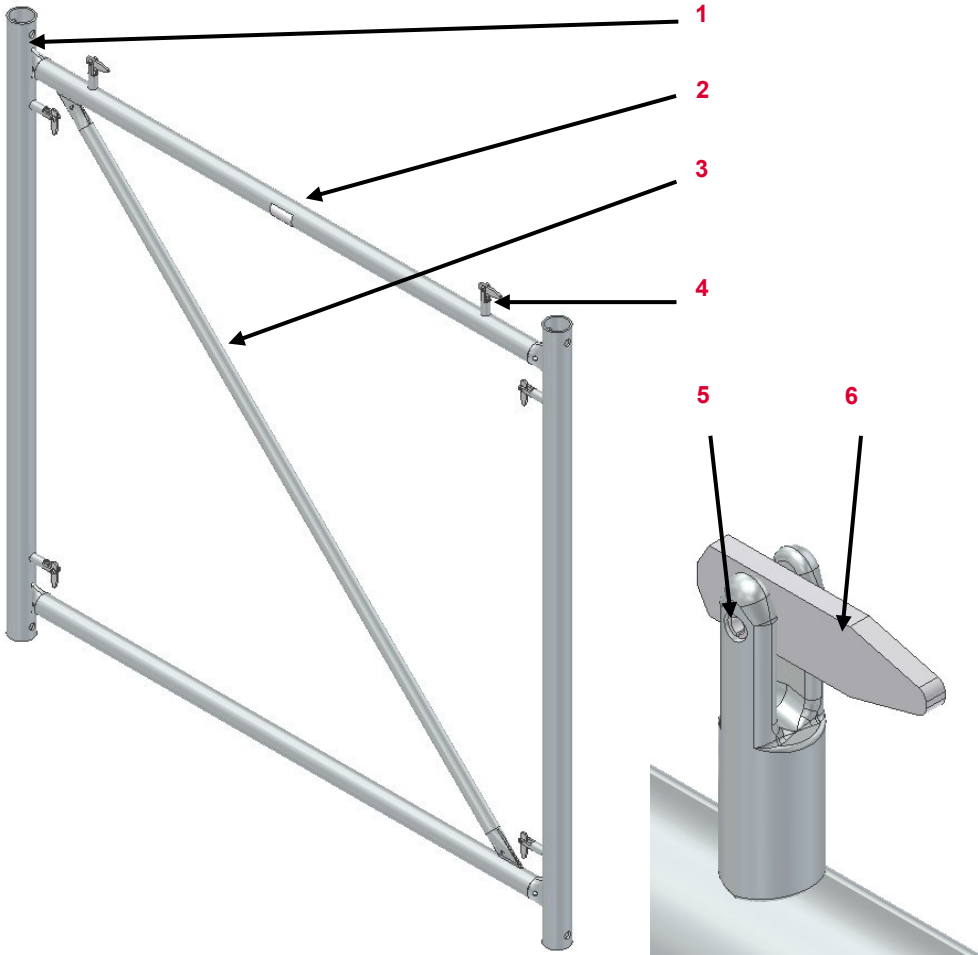

1	Vertical tube	
2	Horizontal tube	
3	Diagonal tube	
4	Pin	730641
5	Sleeve	018510
6	Profile	710123









Valid for

Frame R 150 galv.	018510
Frame R 110, galv.	018520

# PERI Rental Criteria

## PD 8 System





Frame	Description	Instruction	Billing Instruction	Type
	<p>15.01 Crack in pin (base material not affected)</p>			
	<p>15.02 Crack in pin (Base material affected)</p>	 		

# PERI Rental Criteria

## PD 8 System













Frame	Description	Instruction	Billing Instruction	Type
	<b>15.03 Pin bent</b>			
	<ul style="list-style-type: none"> <li>■ If possible</li> </ul>		088244	
	<ul style="list-style-type: none"> <li>■ Or if not possible</li> </ul>			
	<ul style="list-style-type: none"> <li>■ Or with crack in base material</li> </ul>			
	<b>15.04 Pin missing</b>			
	<ul style="list-style-type: none"> <li>■ Without crack in base material</li> </ul>			
	<ul style="list-style-type: none"> <li>■ Or with crack in base material</li> </ul>			

# PERI Rental Criteria

## PD 8 System













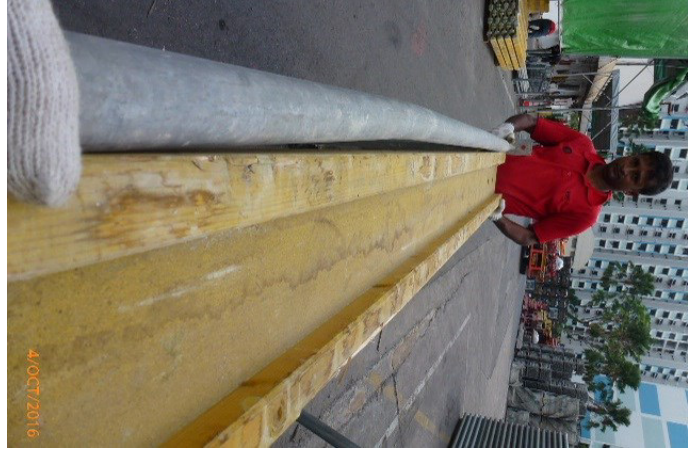



Frame	Description	Instruction	Billing Instruction	Type
	<p><b>15.05 Plaid</b></p> <ul style="list-style-type: none"> <li>■ Missing</li>   <li>■ Or bent</li> </ul>	<p>  710123 (plaid)            018510 (Sleeve)         </p> <p>  710123 (plaid)            018510 (Sleeve)         </p>	<p>  088391         </p> <p>  088391         </p>	<p>  </p> <p>  </p>
 <p style="text-align: right; color: orange;">11.01.2016</p>	<p><b>15.06 Heavily soiled</b></p>	<p>  </p>	<p>  </p>	<p>  </p>



# PERI Rental Criteria

## PD 8 System















Frame	Description	Instruction	Billing Instruction	Type
	<p><b>15.07 Frame bent</b></p> <ul style="list-style-type: none"> <li>■ ≤ 3 mm (l/500)</li> <li>■ Or &gt; 3 mm (l/500)</li> </ul>	<ul style="list-style-type: none"> <li>■ </li> <li>■ </li> </ul>	<ul style="list-style-type: none"> <li>■  088244</li> <li>■ </li> </ul>	<ul style="list-style-type: none"> <li>■ </li> <li>■ </li> </ul>
	<p><b>15.08 Tube cut end crushed</b></p> <ul style="list-style-type: none"> <li>■ Without crack in zinc layer</li> <li>■ Or with crack in zinc layer</li> </ul>	<ul style="list-style-type: none"> <li>■ </li> <li>■ </li> </ul>	<ul style="list-style-type: none"> <li>■  088244</li> <li>■ </li> </ul>	<ul style="list-style-type: none"> <li>■ </li> <li>■ </li> </ul>

# PERI Rental Criteria

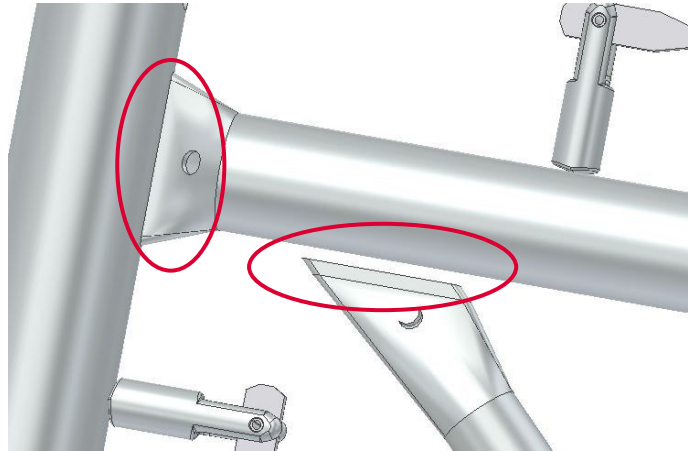
## PD 8 System











Frame	Description	Instruction	Billing Instruction	Type
	<p><b>15.09 Tube dent</b></p> <ul style="list-style-type: none"> <li>■ <math>d \leq 5 \text{ mm}</math></li> <li>■ Or <math>d &gt; 5 \text{ mm}</math></li> </ul>	<ul style="list-style-type: none"> <li>   </li> <li>   </li> </ul>	<ul style="list-style-type: none"> <li>  </li> <li>  </li> </ul>	<ul style="list-style-type: none"> <li>  </li> <li>  </li> </ul>
	<p><b>15.10 Crack in welding at the tubes</b></p>	 		

# PERI Rental Criteria

## PD 8 System











Frame	Description	Instruction	Billing Instruction	Type
	<p>15.11 Frame with squeezed tube</p>			
	<p>15.12 Tube with circular cross section</p>	 		



# PERI Rental Criteria

## PD 8 System











Frame	Description	Instruction	Billing Instruction	Type
	<p>15.13 Frame with half squeezed cross tube</p>			
	<p>15.14 Frame with half squeezed tube</p>			

# PERI Rental Criteria

## PD 8 System



Frame	Description	Instruction	Billing Instruction	Type
	<p>15.15 Execution with squeezed tube</p>			
	<p>15.16 Diagonal tube with circular cross section</p>			

# PERI Rental Criteria

## PD 8 System



Frame	Description	Instruction	Billing Instruction	Type
-------	-------------	-------------	---------------------	------



15.17 Frames with an execution like shown in picture



15.18 Diagonal tube bent

R110                  R150

- ≤ 3,0 mm                  ≤ 3,50 mm
- ≤ 5,0 mm                  ≤ 6,0 mm
- > 5,0mm                  > 6,0mm















088244



# PERI Rental Criteria

## PD 8 System



Diagonalrohr	Description	Instruction	Billing Instruction	Type
	<p><b>15.19 Frame heated</b></p>			
	<p><b>15.20 Objects in tube</b></p> <ul style="list-style-type: none"> <li>■ Removing of the Objects not possible</li> </ul>			
	<p><b>15.21 Damage around the hole</b></p>			

# PERI Rental Criteria

## PD 8 System



Diagonal brace	No.	Name	Article number
----------------	-----	------	----------------

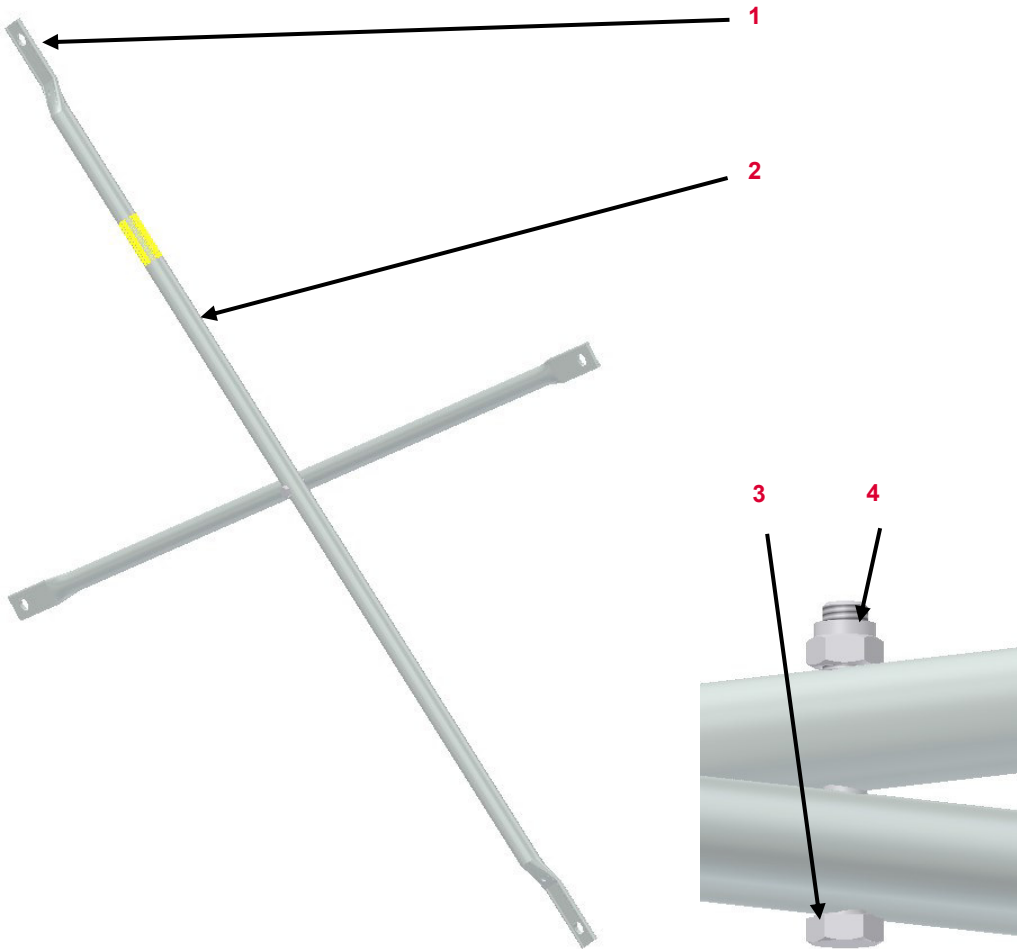

1	Connection	
2	Brace	
3	Bolt M12x 85	710254
4	Nut M12	710381

**Valid for**









Diagonal brace DK 125	018150
Diagonal brace DK 150	018160
Diagonal brace DK 186	019210
Diagonal brace DK 200	018170
Diagonal brace DK 250	018180
Diagonal brace DK 300	018190
Diagonal brace DK 310	018230
Diagonal brace DK 350	018200
Diagonal brace DK 125/110	019150
Diagonal brace DK 150/110	019160
Diagonal brace DK 200/110	019170
Diagonal brace DK 250/110	019180
Diagonal brace DK 300/110	019190
Diagonal brace DK 310/110	019220



# PERI Rental Criteria

## PD 8 System



















Diagonal brace	Description	Instruction	Billing Instruction	Type
	<b>15.22 Diagonal brace bent</b>			
	<ul style="list-style-type: none"> <li>■ ≤ valid bent (l/500)</li> </ul>		 088244	
	<ul style="list-style-type: none"> <li>■ Or &gt; valid bent (l/500)</li> </ul>	 		
	<b>Valid for</b>	<b>Valid bent</b>		
	Diagonal brace DK 125	3 mm		
	Diagonal brace DK 150	3 mm		
	Diagonal brace DK 186	4 mm		
	Diagonal brace DK 200	4 mm		
	Diagonal brace DK 250	5 mm		
	Diagonal brace DK 300	6 mm		
Diagonal brace DK 310	6 mm			
Diagonal brace DK 350	7 mm			
Diagonal brace DK 125/110	3 mm			
Diagonal brace DK 150/110	3 mm			
Diagonal brace DK 200/110	4mm			
Diagonal brace DK 250/110	5 mm			
Diagonal brace DK 300/110	6 mm			
Diagonal brace DK 310/110	6mm			
Diagonal brace DK-HD 150/110	3mm			
Diagonal brace DK-HD 150/150	4 mm			

# PERI Rental Criteria

## PD 8 System















Diagonal brace	Description	Instruction	Billing Instruction	Type
	<b>15.23 Connection bent</b>			
	<ul style="list-style-type: none"> <li>■ <math>\leq 15</math></li> </ul>		 088244	
	<ul style="list-style-type: none"> <li>■ Or <math>&gt; 15</math></li> <li>■ Or cracks in material</li> </ul>	 	 	 
	<b>15.24 Dent in tube</b>			
	<ul style="list-style-type: none"> <li>■ <math>d \leq 5</math> mm</li> <li>■ Or <math>t &gt; 5</math> mm</li> </ul>	 	 	 

# PERI Rental Criteria

## PD 8 System



Diagonal brace	Description	Instruction	Billing Instruction	Type
	<p>15.25 Heavily rusted</p>			
	<p>15.26 Rusty screws and nuts</p>	 <p>710254 (screw) 710381 (nut)</p>		
	<p>15.27 Heated tubes</p>			

# PERI Rental Criteria

## PD 8 System



















Load tower brace 165; 186 (019650; 019640)	Description	Instruction	Billing Instruction	Type
	<b>15.28 Bent</b>			
	■ $\leq$ valid bent (l/500)		088244	
	■ Or $>$ valid bent (l/500)			
	Valid for	Valid bent		
	Load tower brace LS 165	3 mm		
	Load tower brace LS 186	4 mm		
<p data-bbox="174 1380 517 1444">270.18.09e Lastturmstrebe 165</p>	<b>15.29 Connection bent</b>			
	■ $\leq 15^\circ$		088244	
	■ Or $> 15^\circ$			
	■ Or cracks in connection			

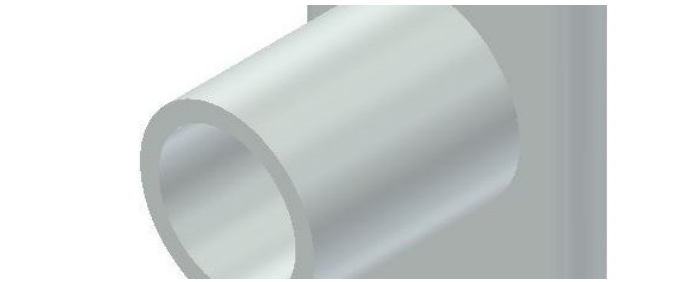

# PERI Rental Criteria

## PD 8 System

















Load tower brace 165; 186 (019650; 019640)	Description	Instruction	Billing Instruction	Type
	<b>15.30 Rusty braces</b>			
	<ul style="list-style-type: none"> <li data-bbox="846 566 1294 614">■ Only superficial and local rust</li> <li data-bbox="846 710 1294 751">■ Or complete brace full of rust</li> </ul>	<div data-bbox="1294 550 1377 630" style="display: inline-block; margin-right: 10px;">✓</div> <div data-bbox="1294 702 1451 774" style="display: inline-block;">  </div>	<div data-bbox="1787 550 1870 630" style="display: inline-block; margin-right: 10px;"></div> <div data-bbox="1787 702 1870 774" style="display: inline-block;"></div>	<div data-bbox="2078 550 2166 630" style="display: inline-block; margin-right: 10px;"></div> <div data-bbox="2078 702 2166 774" style="display: inline-block;"></div>
	<b>15.31 Heavily soiled</b>			
	<b>15.32 Distance piece</b>			
	<ul style="list-style-type: none"> <li data-bbox="846 1252 1294 1300">■ If bending possible</li> <li data-bbox="846 1348 1294 1396">■ Or if not possible</li> <li data-bbox="846 1396 1294 1444">■ Or missing</li> </ul>	<div data-bbox="1294 1244 1377 1316" style="display: inline-block; margin-right: 10px;"></div> <div data-bbox="1294 1364 1451 1436" style="display: inline-block;">  </div>	<div data-bbox="1787 1244 1870 1316" style="display: inline-block; margin-right: 10px;"></div> <div data-bbox="1787 1364 1870 1436" style="display: inline-block;"></div>	<div data-bbox="2078 1244 2166 1316" style="display: inline-block; margin-right: 10px;"></div> <div data-bbox="2078 1364 2166 1436" style="display: inline-block;"></div>



# PERI Rental Criteria

## PD 8 System





Connector with washer (018140)	Description	Instruction	Billing Instruction	Type
	<p><b>15.33 Washer bent</b></p> <ul style="list-style-type: none"> <li>■ ≤ 10 mm</li> <li>■ Or &gt; 10 mm</li> <li>■ Or loose   missing</li> </ul>	<ul style="list-style-type: none"> <li></li> <li></li> <li></li> </ul>	<ul style="list-style-type: none"> <li> 088244</li> <li></li> <li></li> </ul>	<ul style="list-style-type: none"> <li></li> <li></li> <li></li> </ul>
	<p><b>15.34 Tube squeezed</b></p> <ul style="list-style-type: none"> <li>■ D &gt; 5 mm</li> </ul>	<ul style="list-style-type: none"> <li></li> </ul>	<ul style="list-style-type: none"> <li></li> </ul>	<ul style="list-style-type: none"> <li></li> </ul>

# PERI Rental Criteria

## PD 8 System

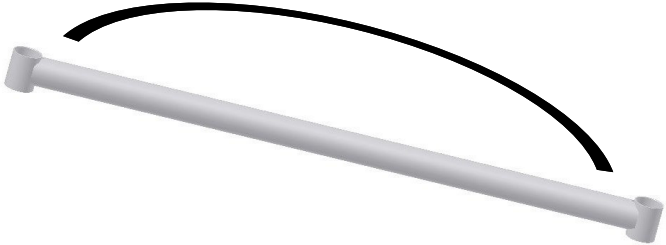





















Reinforcement Support (019630)	Description	Instruction	Billing Instruction	Type
	<p><b>15.35 Bent</b></p> <ul style="list-style-type: none"> <li>■ ≤ 3 mm (l/500)</li> <li>■ Or &lt; 3 mm (L/500)</li> </ul>	<ul style="list-style-type: none"> <li>✓</li> <li>🗑️ 🚫</li> </ul>	<ul style="list-style-type: none"> <li>🚫</li> <li>🗑️</li> </ul>	<ul style="list-style-type: none"> <li>👁️</li> <li>⚠️</li> </ul>
	<p><b>15.36 Connection</b></p> <ul style="list-style-type: none"> <li>■ Squeezed   bent</li> <li>■ Or crack in welding</li> </ul>	<ul style="list-style-type: none"> <li>🗑️ 🚫</li> <li>🗑️ 🚫</li> </ul>	<ul style="list-style-type: none"> <li>🗑️</li> <li>🗑️</li> </ul>	<ul style="list-style-type: none"> <li>⚙️</li> <li>⚠️</li> </ul>

# PERI Rental Criteria

## PD 8 System



### PD 8 Ledger Bottom (124264; 124268)

	Description	Instruction	Billing Instruction	Type
	<p><b>15.37 Sleeve bent</b></p> <ul style="list-style-type: none"> <li>Without cracks in welding</li> <li>Or with crack in welding</li> <li>Or crack in sleeve</li> </ul>	<ul style="list-style-type: none"> <li></li> <li></li> <li></li> </ul>	<ul style="list-style-type: none"> <li> 088244</li> <li></li> <li></li> </ul>	<ul style="list-style-type: none"> <li></li> <li></li> <li></li> </ul>
	<p><b>15.38 Dent in profile</b></p> <ul style="list-style-type: none"> <li>≤ 10 mm</li> <li>Or &gt; 10 mm</li> <li>Or kink</li> </ul>	<ul style="list-style-type: none"> <li></li> <li></li> <li></li> </ul>	<ul style="list-style-type: none"> <li> 088244</li> <li></li> <li></li> </ul>	<ul style="list-style-type: none"> <li></li> <li></li> <li></li> </ul>

# PERI Rental Criteria

## PD 8 System



Spindle TR48 (018120; 018030)	Description	Instruction	Billing Instruction	Type
-------------------------------	-------------	-------------	---------------------	------

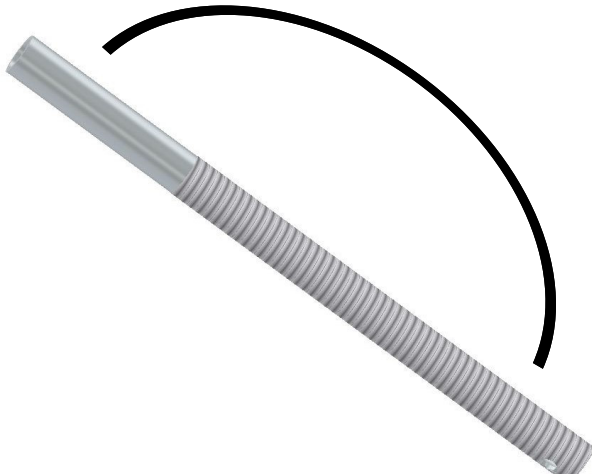

**15.39 Spindle bent**

- > 5 mm



**15.40 Thread**









- Heavily soiled
- Or damaged (wingnut not moveable)

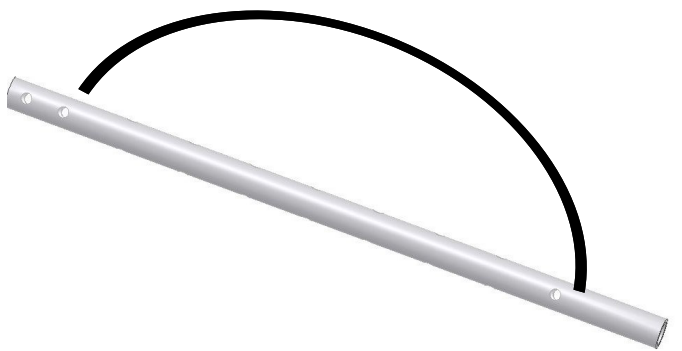

# PERI Rental Criteria

## PD 8 System











Foot tube FR 80 (018110)	Description	Instruction	Billing Instruction	Type
	<p><b>15.41 Tube bent</b></p> <ul style="list-style-type: none"> <li>■ &gt; 3 mm</li> </ul>			
	<p><b>15.42 Tube bent</b></p> <ul style="list-style-type: none"> <li>■ &gt; 3 mm</li> </ul>			

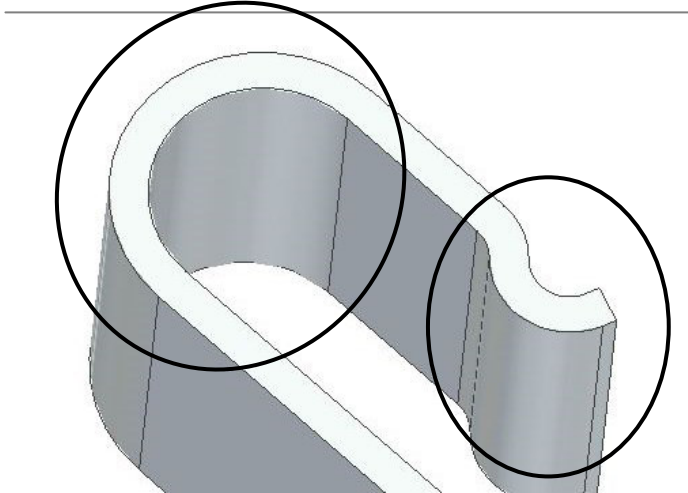

# PERI Rental Criteria

## PD 8 System















Safety strap (019620; 116767)	Description	Instruction	Billing Instruction	Type
	<p>15.43 Bent</p>			
	<p>15.44 Radius bent</p>			

# PERI Rental Criteria

## PD 8 System



Girder strap TB (024060)	Description	Instruction	Billing Instruction	Type
	<p><b>15.44 Bent</b></p> <ul style="list-style-type: none"> <li>■ ≤ 5 mm</li> </ul>			
	<p><b>15.45 Kink</b></p> <ul style="list-style-type: none"> <li>■ &gt; 5 mm</li> </ul>			
	<p><b>15.46 Thread damaged</b></p> <ul style="list-style-type: none"> <li>■ Nut not moveable</li> </ul>			

# PERI Rental Criteria

## PD 8 System



Double girder strap (024010)	Description	Instruction	Billing Instruction	Type
------------------------------	-------------	-------------	---------------------	------



15.47 Bent













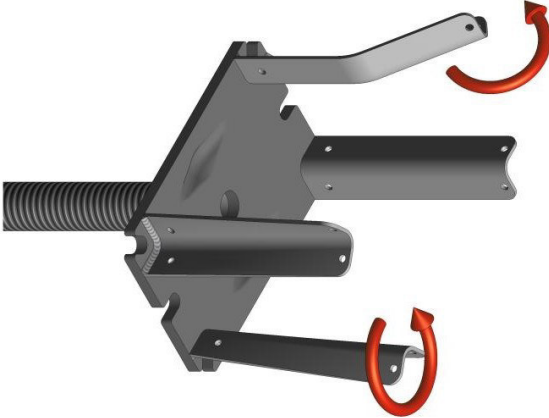



15.48 Thread not viable



# PERI Rental Criteria

## PD 8 System











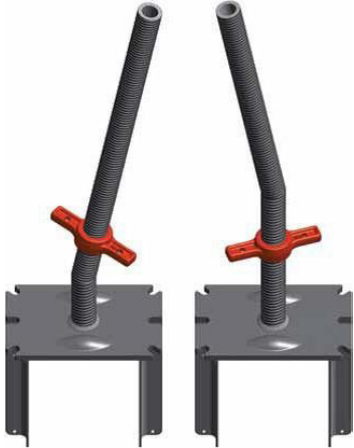





Cross Head spindle TR 48-/5/47 (018630)	Description	Instruction	Billing Instruction	Type
	<p><b>15.34 Plaid bent</b></p> <ul style="list-style-type: none"> <li>■ Bent (without crack in welding)</li> <li>■ Or bent with crack in welding</li> <li>■ Or missing</li> </ul>	<ul style="list-style-type: none"> <li></li> <li></li> <li></li> </ul>	<ul style="list-style-type: none"> <li> 088395</li> <li> 088394</li> <li> 088394</li> </ul>	<ul style="list-style-type: none"> <li></li> <li></li> <li></li> </ul>
	<p><b>15.35 Base plate bent</b></p> <ul style="list-style-type: none"> <li>■ &gt; 5 mm</li> </ul>	<ul style="list-style-type: none"> <li> </li> </ul>	<ul style="list-style-type: none"> <li></li> </ul>	<ul style="list-style-type: none"> <li></li> </ul>

# PERI Rental Criteria

## PD 8 System



Cross Head Spindle TR 48-/5/47 (018630)	Description	Instruction	Billing Instruction	Type
	<p><b>15.51 Spindle bent</b></p>			
	<p><b>15.52 Spindle</b></p> <ul style="list-style-type: none"> <li>■ Cut off</li> <li>■ Or missing</li> <li>■ Or thread damaged (wingnut not moveable)</li> </ul>	  	  	  



# PERI Rental Criteria

## PD 8 System



Trolley with Winch (019200)	No.	Name	Article number
-----------------------------	-----	------	----------------

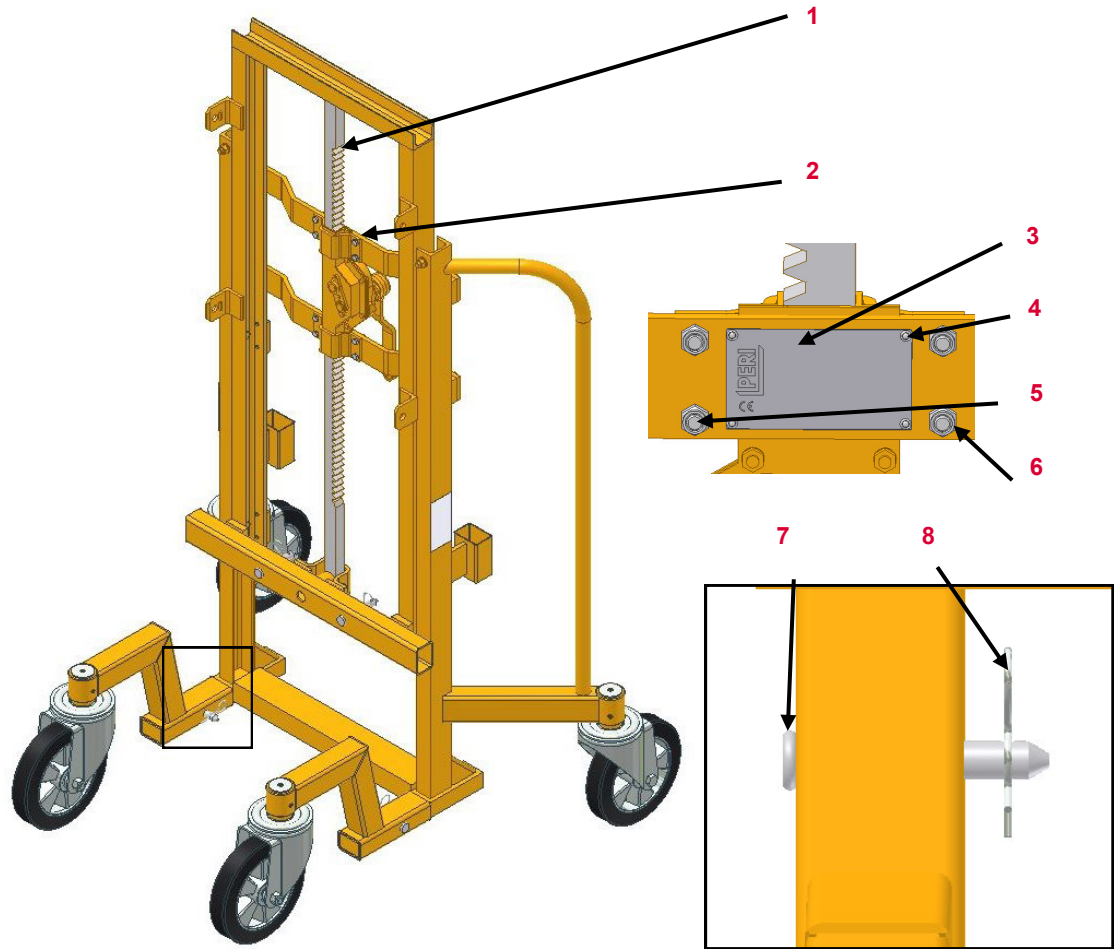















1	Winch	019140
2	Roll	710973
3	Type plate	710311
4	Rivet	767043
5	Screw	722342
6	Nut	711071
7	Bolt	018050
8	Cotter pin	018060

# PERI Rental Criteria

## PD 8 System

















Trolley with Winch	Description	Instruction	Billing Instruction	Type
	<p><b>15.53 Worn break</b></p> <ul style="list-style-type: none"> <li>■ Gab at winch &gt; 10 mm</li> </ul>			
	<p><b>15.54 Roll</b></p> <ul style="list-style-type: none"> <li>■ Worn</li> <li>■ Or damaged by force</li> <li>■ Or missing</li> </ul>	<ul style="list-style-type: none"> <li> 710973 (roll)</li> <li> 710973 (roll)</li> <li> 710973 (roll)</li> </ul>	<ul style="list-style-type: none"> <li></li> <li></li> <li></li> </ul>	<ul style="list-style-type: none"> <li></li> <li></li> <li></li> </ul>

# PERI Rental Criteria

## PD 8 System









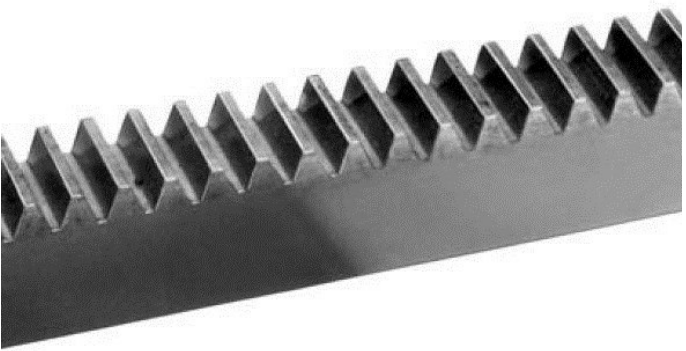

Trolley with Winch	Description	Instruction	Billing Instruction	Type
	<p><b>15.55 Winch</b></p> <ul style="list-style-type: none"> <li>■ Missing parts</li> <li>■ Or damaged parts</li> </ul>	<ul style="list-style-type: none"> <li></li> <li></li> </ul>	<ul style="list-style-type: none"> <li></li> <li></li> </ul>	<ul style="list-style-type: none"> <li></li> <li></li> </ul>
	<p><b>15.56 Winch not moveable</b></p> <ul style="list-style-type: none"> <li>■ Worn</li> <li>■ Or damaged by force</li> </ul>	<ul style="list-style-type: none"> <li> 019140 (winch)</li> <li> 019140 (winch)</li> </ul>	<ul style="list-style-type: none"> <li> 088891</li> <li> 088891</li> </ul>	<ul style="list-style-type: none"> <li></li> <li></li> </ul>

# PERI Rental Criteria

## PD 8 System











Trolley with winch	Description	Instruction	Billing Instruction	Type
	<p><b>15.57 Rag bent</b></p>	<p> 019140 (rag)</p>	<p> 088891</p>	
	<p><b>15.58 Rag</b></p> <ul style="list-style-type: none"> <li>■ Teeth broken</li> <li>■ Or worn (teeth ate curved or sharp)</li> </ul>	<p> 019140 (rag)</p> <p> 017140 (rag)</p>	<p> 088891</p> <p></p>	 

# PERI Rental Criteria

## PD 8 System



Trolley with winch	Description	Instruction	Billing Instruction	Type
	<p>15.59 Frame bent</p>			
	<p>15.60 Handle bent</p>		 088244	



# PERI Rental Criteria

## PD 8 System



Trolley with Winch	Description	Instruction	Billing Instruction	Type
	<b>15.61 Type plate not readable   missing</b>		088037	
	<b>15.62 Bolts   Screws   Cotter pin</b>  <ul style="list-style-type: none"> <li>■ Missing</li> <li>■ Or damaged</li> </ul>	  	  	  
	<b>15.63 Damaged welding</b>			



# PERI Rental Criteria

## PD 8 System



Castor PD 8 (018260)	No.	Name	Article number
----------------------	-----	------	----------------

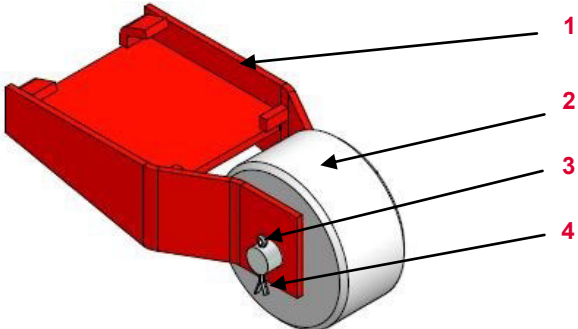

1	Castor		
2	Roll	703965	
3	Bolt	118675	
4	Cotter pin	710921	

Schaden	Description	Instruction	Billing Condition	Type
---------	-------------	-------------	-------------------	------

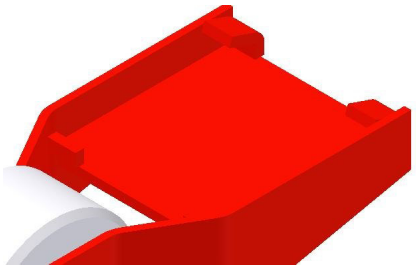

15.64 Castor bent

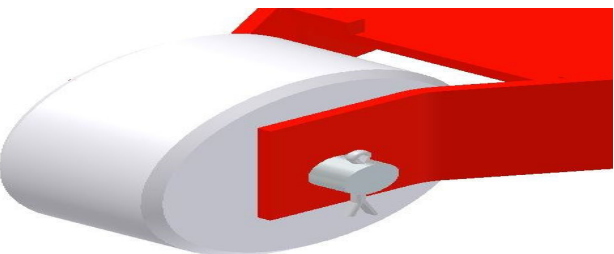

15.65 Roll

■ Worn



■ Or damaged by force



# PERI Rental Criteria

## PD 8 System



PD 8 Lift Unit Lower Part (019070)	Description	Instruction	Billing Instruction	Type
------------------------------------	-------------	-------------	---------------------	------

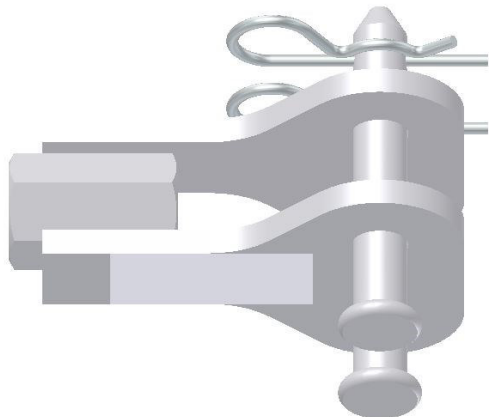

**15.66 Bent**

- If possible
  
- Or if not possible

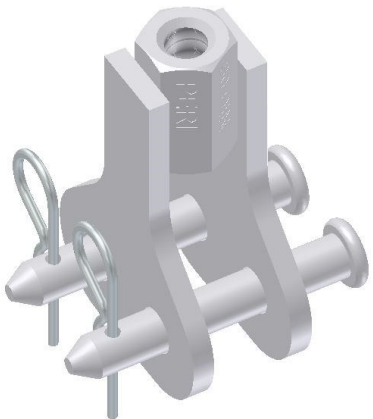

**15.67 Bolt | cotter pin missing**

 018050 (Bolt)  
018060 (cotter pin)









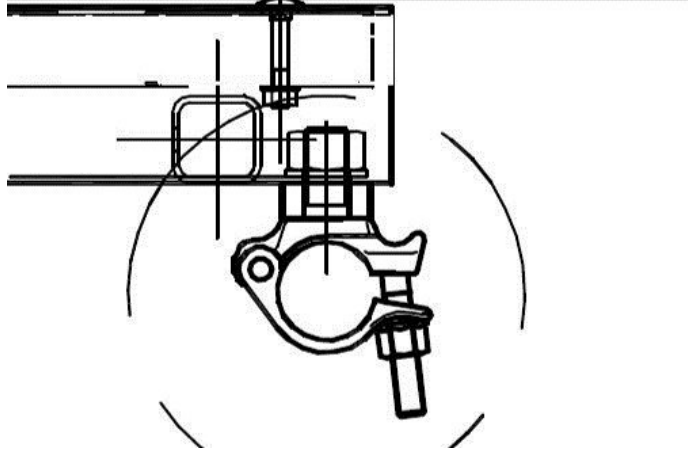

 088192



# PERI Rental Criteria

## PD 8 System



















Stair PD ( 019430)	Description	Instruction	Billing Instruction	Type
	<p><b>15.68 Coupling</b></p> <ul style="list-style-type: none"> <li>■ Missing</li> <li>■ Or damaged</li> </ul>	<p>017040</p>  <p>017040</p> 	<p>088461</p>  <p>088461</p> 	 
	<p><b>15.69 Grating damaged</b></p>	 <p>710982 (Grating 570x30) 710983 (Grating 570x82) 710984 (Grating 570x61)</p>		

# PERI Rental Criteria

## Glossary Icons



Icon	Significance	Icon	Significance	Icon	Significance
	Not OK– material is scrap		Billing necessary (customer)		Optical damage
	OK– material stays in rental park		No Billing necessary		Functional damage
	Scrap material– it's not permitted to hand out the material because of safety aspects		Shorten the material		Functional damage— it's <b>not</b> permitted to hand out the material
	Repair according to instruction		Mark the material		Static damage— it's <b>not</b> permitted to hand out the material
	Fix material cold– Afterwards check weld seams and bordering components		Replace damaged material		
	Repair after local economic efficiency calculation		Replace missing material		
	Clean the material				