

# PERI Rental Criteria

## VARIO Accessories

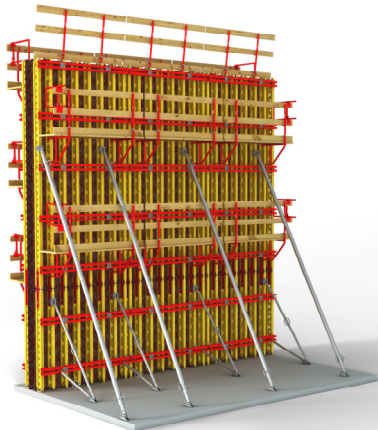

**Contact**

**PERI GmbH**  
**Formwork Scaffolding**  
**Engineering**  
 P.O. Box 1264  
 89264 Weissenhorn, Germany  
 Phone +49 (0) 7309.950-0  
 Fax +49 (0) 7309.951-0  
 rental-criteria@peri.de

Content	Page
Hook Straps	2
Crane Hook-2	17
Tie Yoke Head SRU	19
Various Accessories	20
Glossary	32

Changes made	Date   Initial	Page
New version	01/2018   fw	

# PERI Rental Criteria

## VARIO Accessories



### Hook Strap 24-100/120 | 24-140/160

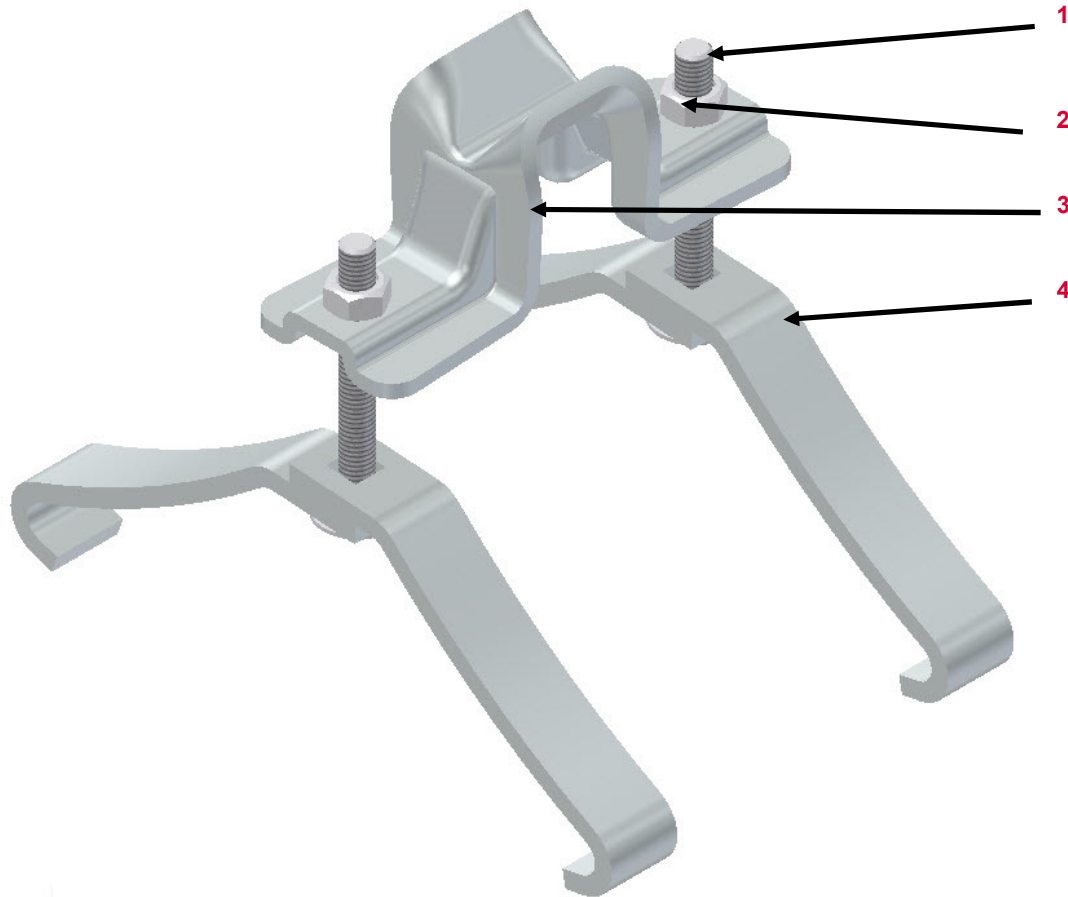

















No.	Name	Article number
1	Bolt	126228
2	Nut	024090
3	Horizontal bracket	710253
4	Tension bracket 24-100/120	024040
4	Tension bracket 24-140/160	722690

Valid for	Article number
Hook Strap 24-100/120	024070
Hook Strap 24-140/160	

# PERI Rental Criteria

## VARIO Accessories





















Hook Strap 24-100/120   24-140/160	Description	Instruction	Billing	Type
	<b>09.01 Bolt   Nut</b>			
	<ul style="list-style-type: none"> <li>■ Missing</li> </ul>			
	<ul style="list-style-type: none"> <li>■ Or bent</li> </ul>			
<ul style="list-style-type: none"> <li>■ Or Rusty</li> </ul>				
	<b>09.02 Tension bracket</b>			
	<ul style="list-style-type: none"> <li>■ Missing</li> </ul>			
<ul style="list-style-type: none"> <li>■ Or bent</li> </ul>				

# PERI Rental Criteria

## VARIO Accessories



Hook Strap 24-100/120   24-140/160	Description	Instruction	Billing	Type
	<b>09.03 Rusty</b>	<ul style="list-style-type: none"> <li>■ Degree of rust A; B or C </li> </ul>		
	<ul style="list-style-type: none"> <li>■ Degree of rust &gt; C</li> </ul>	 		
	<b>09.04 Soiled heavily</b>	<ul style="list-style-type: none"> <li>■ If removable </li> </ul>		
	<ul style="list-style-type: none"> <li>■ Or if not and parts replaceable</li> </ul>			
	<ul style="list-style-type: none"> <li>■ Or if parts not replaceable</li> </ul>			

# PERI Rental Criteria

## VARIO Accessories



### Hook Strap Uni HBU

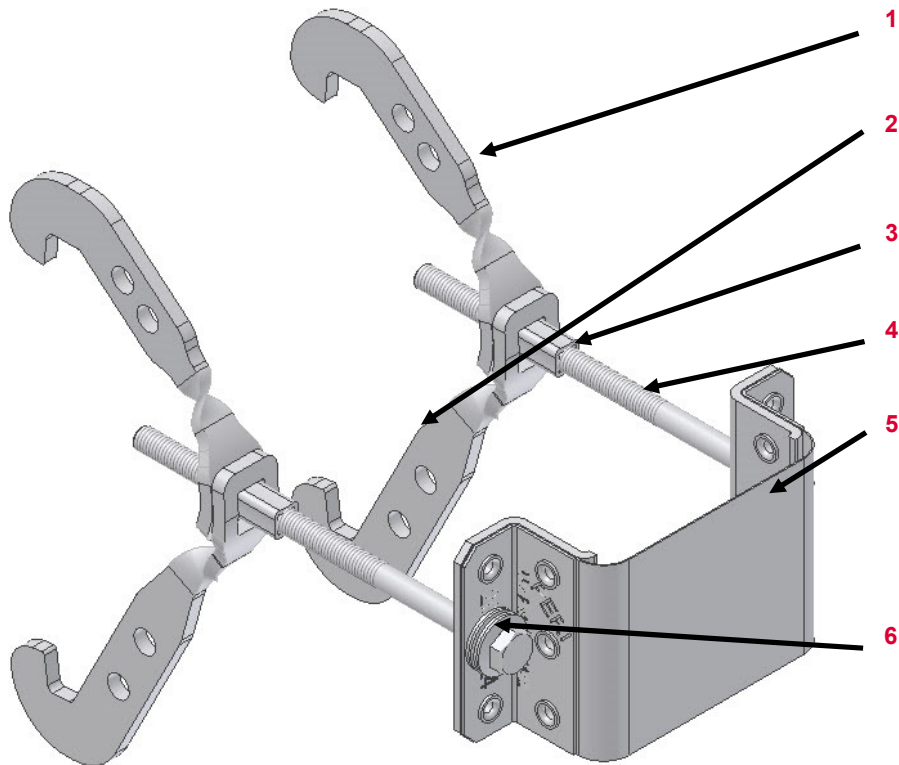

No.	Name	Article number
1	Hook 123	103840
2	Hook 160	103842
3	Sleeve	103844
4	Bolt	
5	Strap	
6	Disk spring	109870

Valid for	Article number
Hook Strap Universal HBU 24-28	103845
Hook Strap Universal HBU 20-24	104931
Hook Strap Universal HBU 16-26 U200	111806
Hook Strap Universal Double 24-28	104096
Hook Strap Universal Double 20-24	104930
Hook Strap MPB 24/GT24	111000



# PERI Rental Criteria

## VARIO Accessories



Hook Strap Uni HBU	Description	Instruction	Billing	Type
--------------------	-------------	-------------	---------	------



09.05 Complete Hook strap soiled with concrete

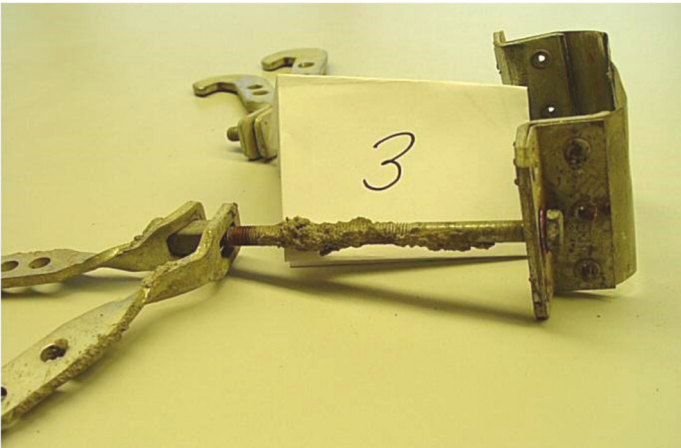



09.06 Bolt soiled with concrete



# PERI Rental Criteria

## VARIO Accessories











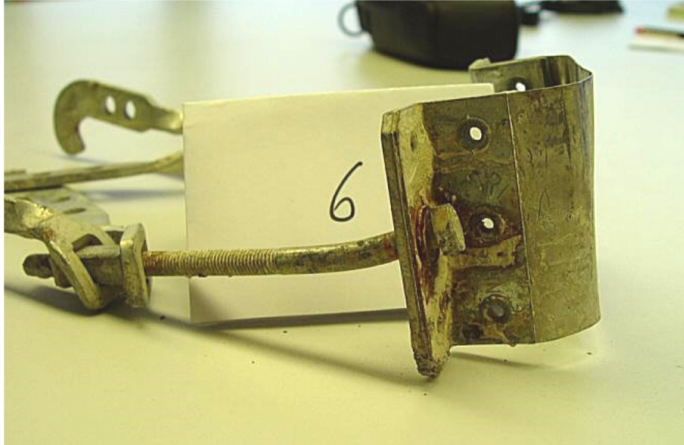





Hook Strap Uni HBU	Description	Instruction	Billing	Type
	<p><b>09.07 Strap soiled with concrete</b></p> <ul style="list-style-type: none"> <li>■ Screws can be tighten</li> <li>■ Or soiled heavily</li> </ul>	<p>✓</p> <p>⚙️</p>	<p>🚫</p> <p>📄</p>	<p>👁️</p> <p>⚙️</p>
	<p><b>09.08 Strap bent</b></p>	<p>⚙️</p>	<p>📄</p>	<p>⚙️</p>

# PERI Rental Criteria

## VARIO Accessories













Hook Strap Uni HBU	Description	Instruction	Billing	Type
	09.09 Bolt bent			
	<p>09.10 Rust</p> <ul style="list-style-type: none"> <li>■ At the bolts (bolts not movable)</li> <li>■ Degree of rust until class C</li> <li>■ Degree of rust D</li> </ul>			
				
				



# PERI Rental Criteria

## VARIO Accessories

















Hook Strap Uni HBU	Description	Instruction	Billing	Type
	<b>09.11 Strap bent</b>	<ul style="list-style-type: none"> <li>■ Smooth bent </li> </ul>		
	<ul style="list-style-type: none"> <li>■ Or kink</li> </ul>			
	<b>09.12 Crack in strap</b>			

# PERI Rental Criteria

## VARIO Accessories



Hook Strap Uni HBU	Description	Instruction	Billing	Type
	<b>09.13 Nail holes</b>			
	<ul style="list-style-type: none"> <li>■ ≤ 25 % material loss</li> </ul>			
	<ul style="list-style-type: none"> <li>■ Or &gt; 25 % material loss</li> </ul>			
	<b>09.14 Dent in strap</b>			
	<ul style="list-style-type: none"> <li>■ ≤ Ø 2 cm</li> </ul>			
<ul style="list-style-type: none"> <li>■ Or &gt; Ø 2 cm</li> </ul>				

# PERI Rental Criteria

## VARIO Accessories



### Hook Strap HB

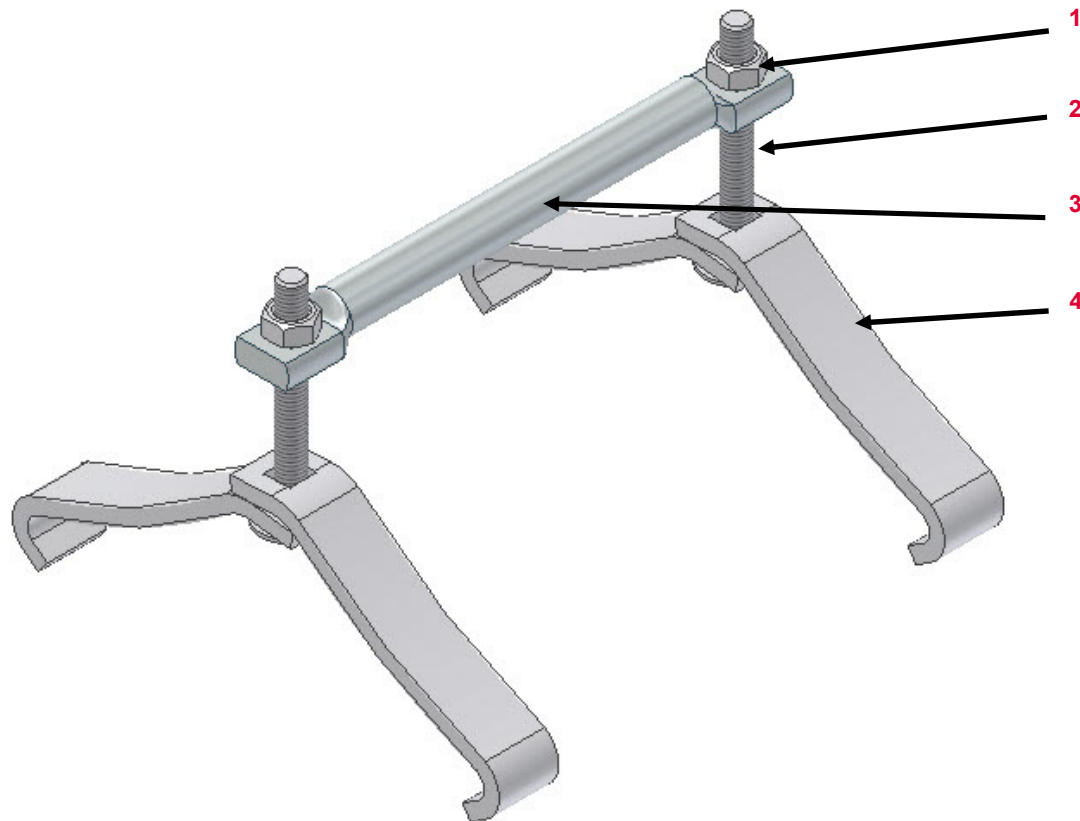





















No.	Name	Article number
1	Nut	024090
2	Bolt	
3	Horizontal bracket	726041
4	Hook HB	024040

Valid for	Article number
Hook Strap HB	024110
Cross Strap HB	024860
Double Hook Strap DHB	024170

# PERI Rental Criteria

## VARIO Accessories



Hook Strap HB	Description	Instruction	Billing	Type
	<b>09.15 Bolts   Nuts   Hooks</b>			
	<ul style="list-style-type: none"> <li>■ Missing</li> </ul>			
	<ul style="list-style-type: none"> <li>■ Or damaged through force</li> </ul>			
<ul style="list-style-type: none"> <li>■ Or soiled</li> </ul>				
	<b>09.16 Horizontal bracket</b>			
	<ul style="list-style-type: none"> <li>■ Missing</li> </ul>			
	<ul style="list-style-type: none"> <li>■ Or damaged through force</li> </ul>			
<ul style="list-style-type: none"> <li>■ Or soiled</li> </ul>				

# PERI Rental Criteria

## VARIO Accessories



### Hook Strap for T20 (024880)

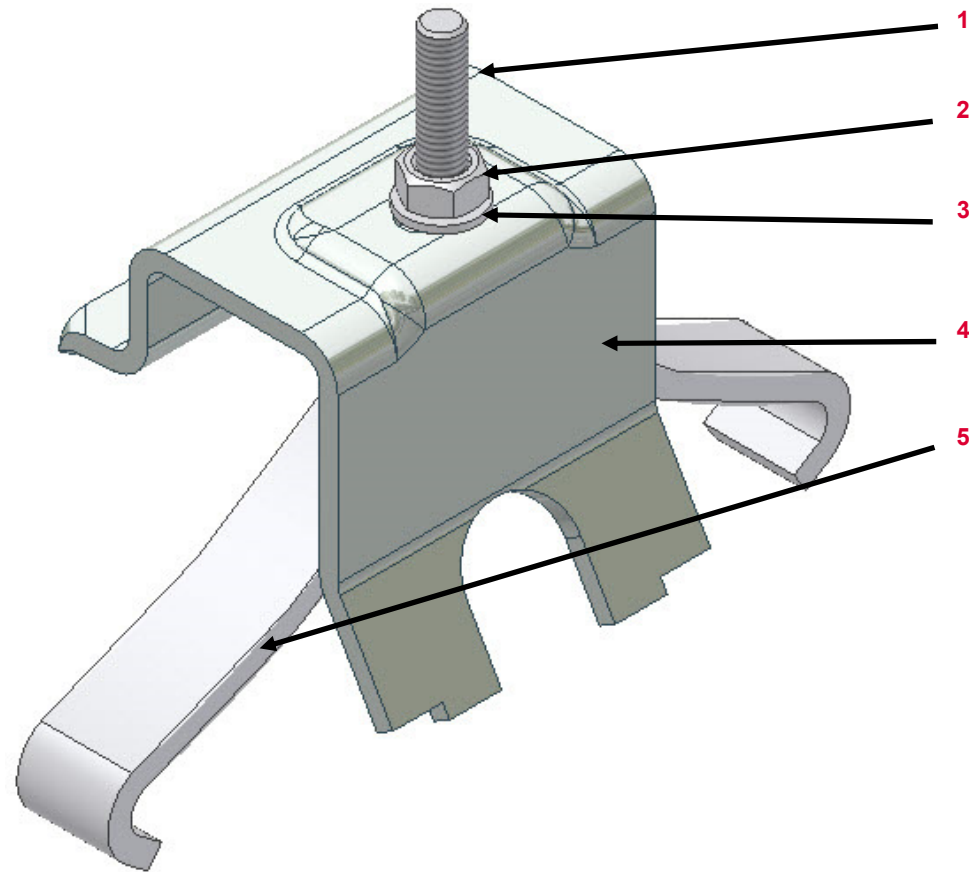

No.	Name	Article number
1	Bolt	126228
2	Nut	024090
3	Washer	780354
4	„Brücke“	721833
5	Hook	024040



# PERI Rental Criteria

## VARIO Accessories



### Fix Strap for U100-120 (024630)

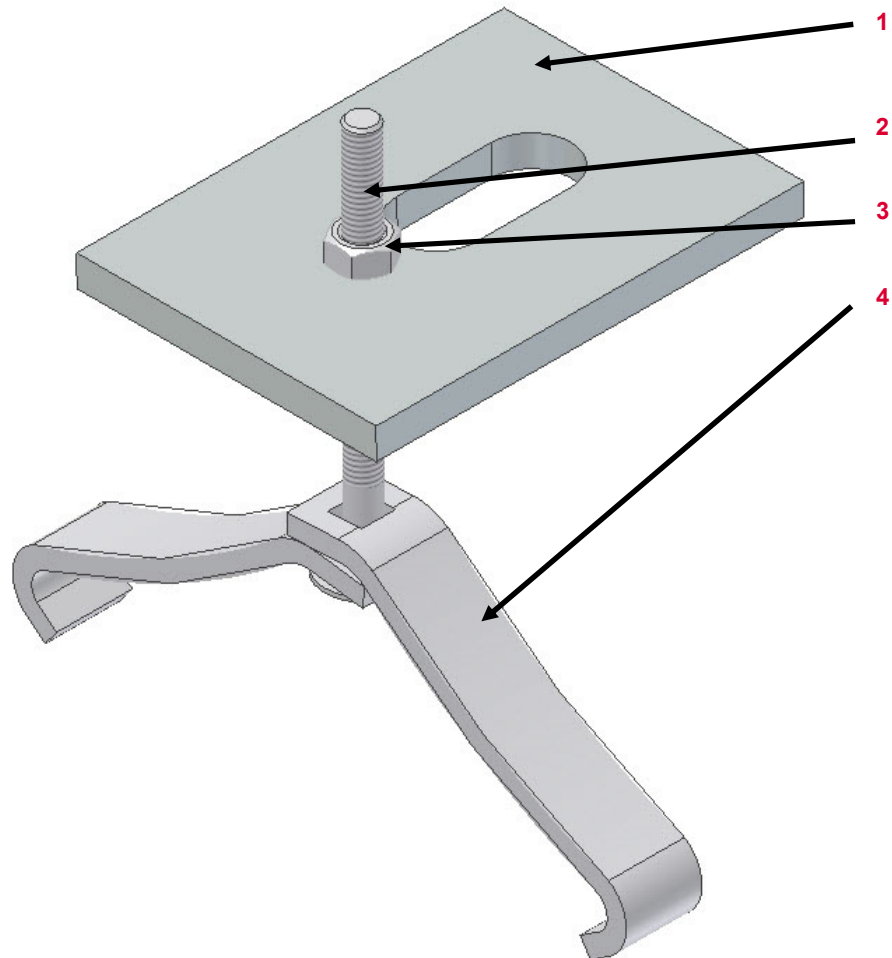

No.	Name	Article number
-----	------	----------------

1	Pressure plate	722670
2	Bolt	710249
3	Nut	024090
4	Hook	024040

# PERI Rental Criteria

## VARIO Accessories



Hook Strap for T20 (024880) Fix Strap (024630) Description	Instruction	Billing	Type
--	-------------	---------	------

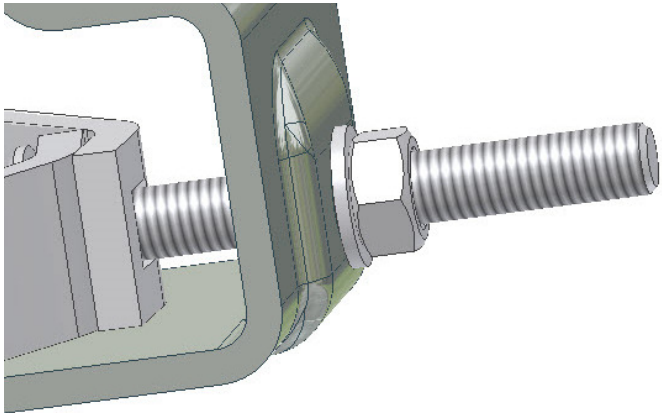

**09.17 Bolt | Nut | Washer**

- Missing
- Or damaged through force
- Or soiled

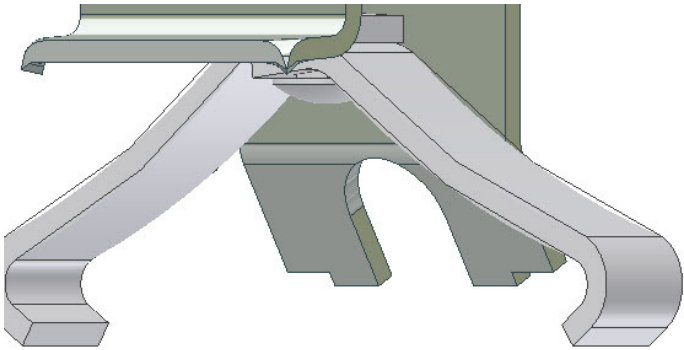

**09.18 Hook**









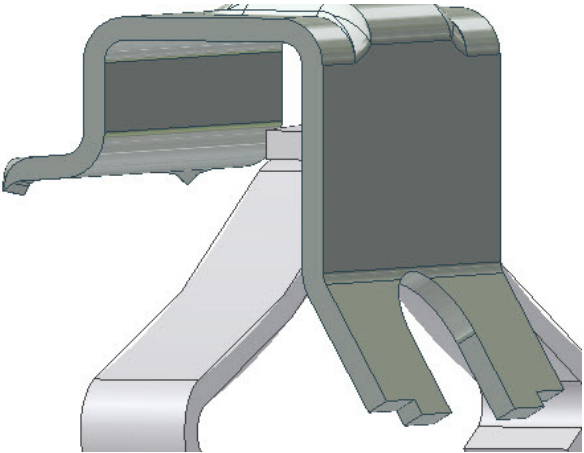

- Missing
- Or damaged through force
- Or soiled

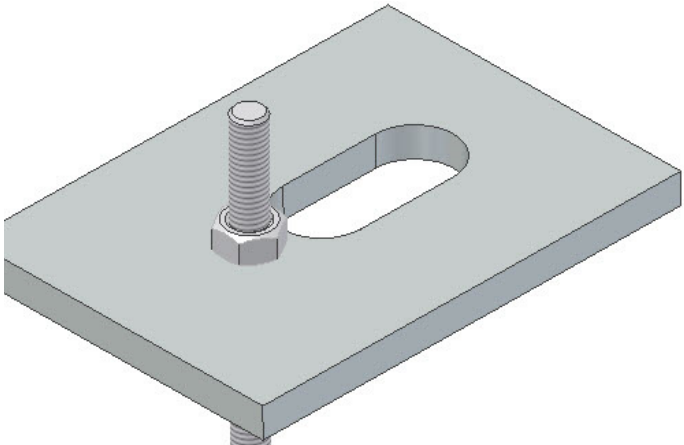

# PERI Rental Criteria

## VARIO Accessories



Hook Strap for T20 (024880) Fix Strap (024630) Description	Instruction	Billing	Type	
	<p>09.19 „Brücke“ bent</p>			
	<p>09.20 Pressure plate</p>	<p>■ Bent</p> 		
	<p>■ Or missing</p>			

# PERI Rental Criteria

## VARIO Accessories



### Crane Hook-2 VT20 (113712)

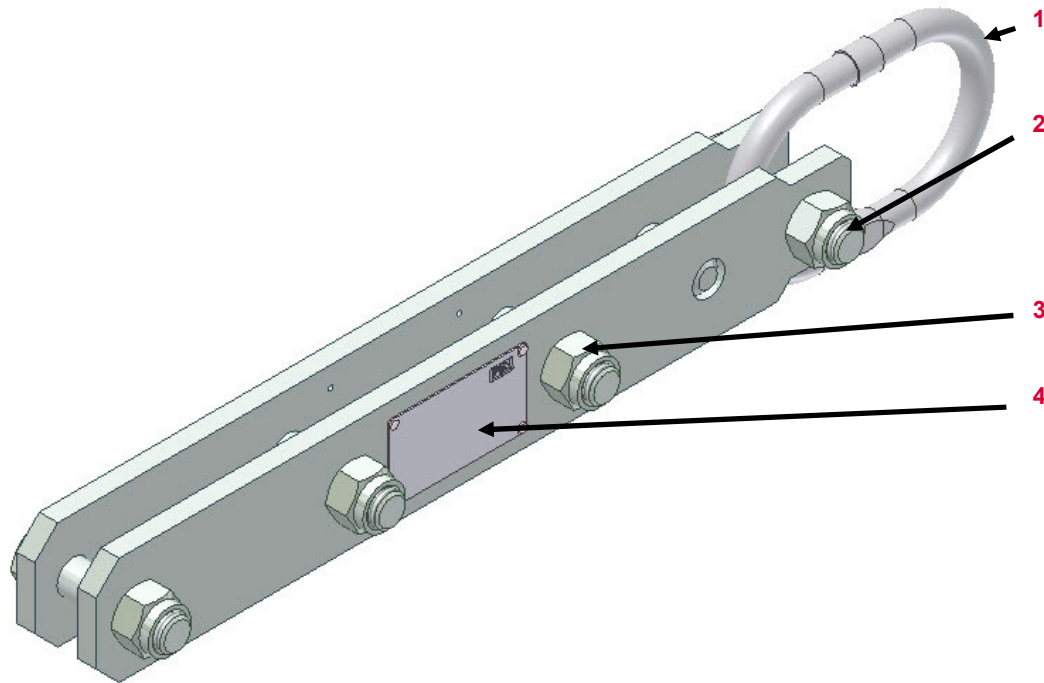









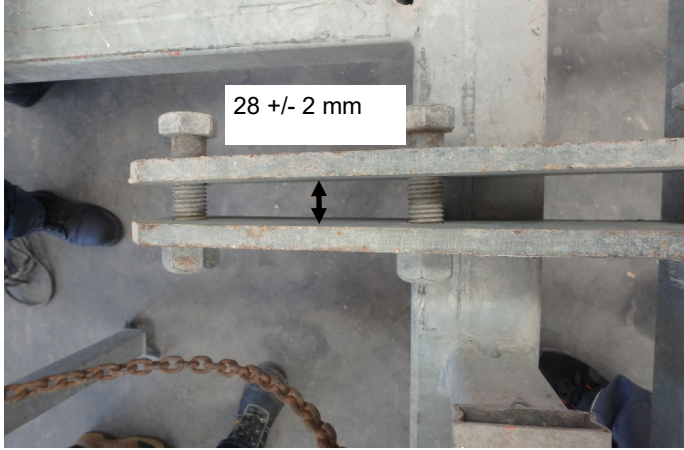





No.	Name	Article number
1	Suspension Link	106894
2	Bolt	024900
3	Nut	781053
4	Type plate	113721

# PERI Rental Criteria

## VARIO Accessories



Crane Hook-2 VT20 (113712)	Description	Instruction	Billing	Type
	<b>09.21 Bent</b>	<ul style="list-style-type: none"> <li>■ Within the tolerance</li> </ul>		
	<ul style="list-style-type: none"> <li>■ Or out of tolerance and repairable</li> </ul>			
	<ul style="list-style-type: none"> <li>■ Or out of tolerance and not repairable</li> </ul>			
	<b>09.22 Bolts   Nuts</b>	<ul style="list-style-type: none"> <li>■ Missing</li> </ul>		
	<ul style="list-style-type: none"> <li>■ Or damaged through force</li> </ul>			



Crane Hook-2 VT20 (113712)	Description	Instruction	Billing	Type
----------------------------	-------------	-------------	---------	------

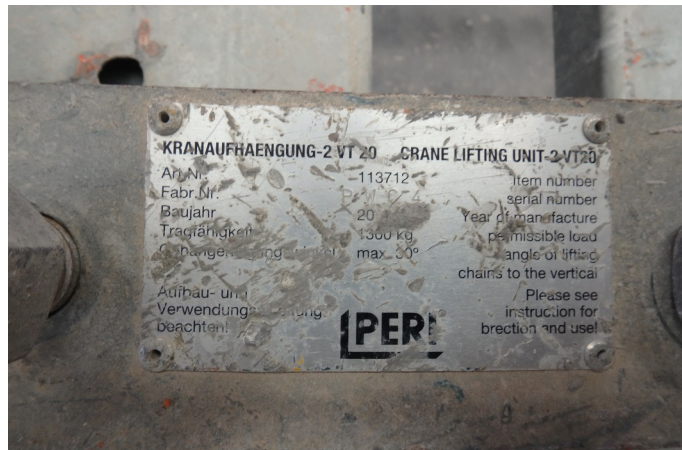

### 09.23 Type plate

- Missing



- Or not readable

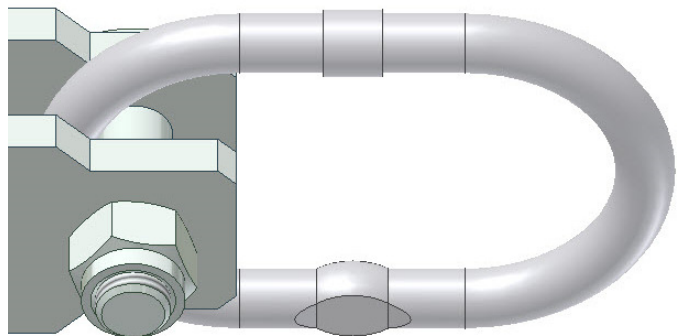

### 09.24 Suspension Link

- Worn ( $\varnothing < 9$  mm)



- Or missing



# PERI Rental Criteria

## VARIO Accessories



### Tie Yoke Head SRU (110756)

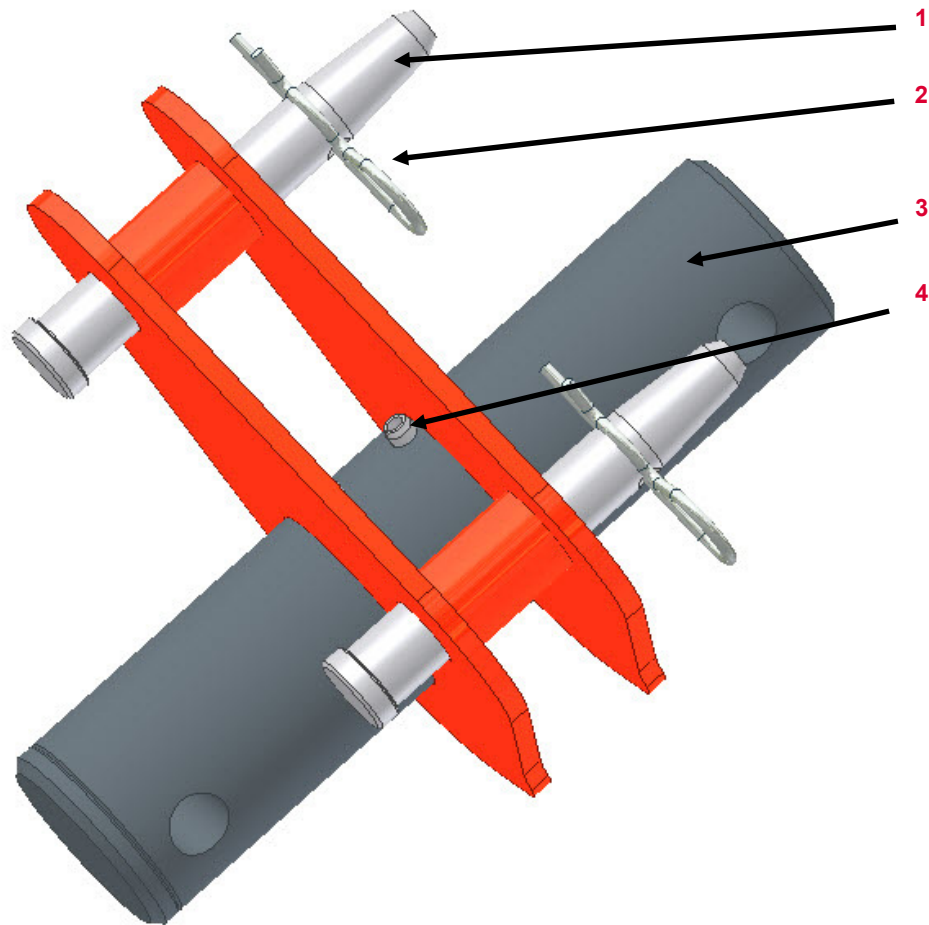













No.	Name	Article number
-----	------	----------------

1	Pin	105400
2	Cotter pin	018060
3	Tie Yoke	131352
4	Dowel pin	770013

# PERI Rental Criteria

## VARIO Accessories











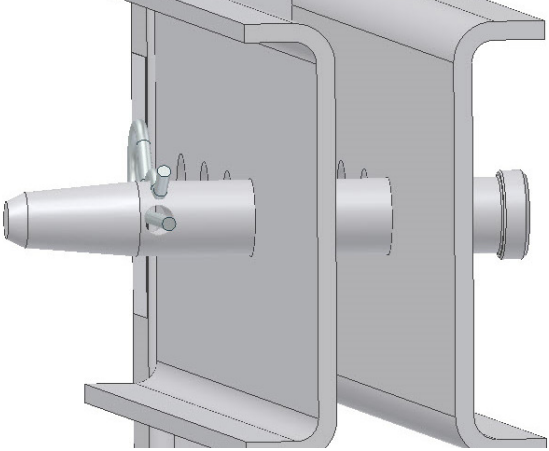

Tie Yoke Head SRU (110756)	Description	Instruction	Billing	Type
	<b>09.25 Pin   Cotter pin   Dowel pin   Tie yoke</b>	 105400 (Pin) 018060 (Spring pin)		
	<ul style="list-style-type: none"> <li>■ Missing</li>   <li>■ Or damaged through force</li> </ul>	 105400 (Pin) 018060 (Spring pin)		
	<b>09.26 Bent</b>			
	<ul style="list-style-type: none"> <li>■ If possible</li>   <li>■ Or if not possible</li> </ul>			

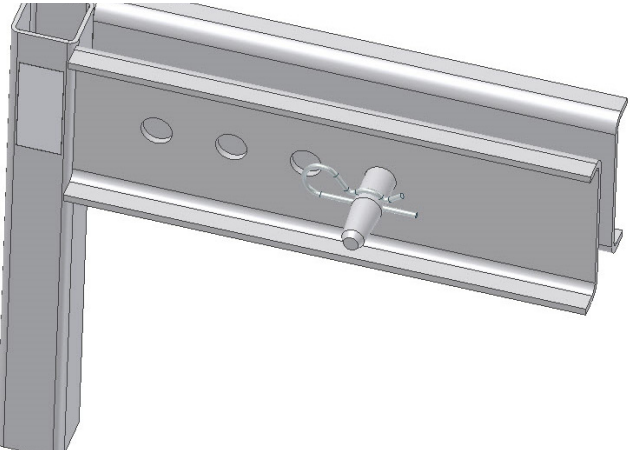
# PERI Rental Criteria

## VARIO Accessories



Handrail Holder GT24/VT20 (101290)	Description	Instruction	Billing	Type
	<p><b>09.27 Bolt   Cotter Pin</b></p>			
	<ul style="list-style-type: none"> <li>■ Missing</li> </ul>	 <p>105400 (Bolt) 018060 (Cotter Pin)</p>		
	<p><b>09.28 Bent</b></p>			
	<ul style="list-style-type: none"> <li>■ If possible</li> </ul>			
	<ul style="list-style-type: none"> <li>■ Or if not possible</li> </ul>			

# PERI Rental Criteria

## VARIO Accessories



Coupling Compression Plate KDP (024220)	Description	Instruction	Billing	Type
---	-------------	-------------	---------	------

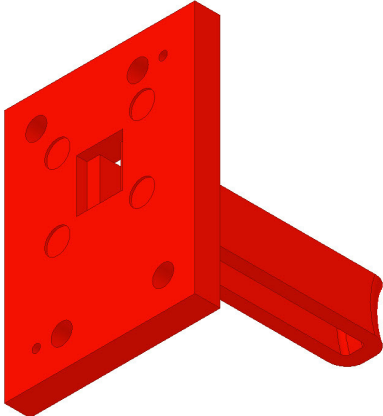

09.29 Bent





# PERI Rental Criteria

## VARIO Accessories















Extension Splice 24 (024480)	Description	Instruction	Billing	Type
	<b>09.30 Bent</b>			
	<ul style="list-style-type: none"> <li>■ If possible</li> </ul>			
	<ul style="list-style-type: none"> <li>■ Or if not possible</li> </ul>			
	<b>09.31 Three wingnut</b>			
	<ul style="list-style-type: none"> <li>■ Missing</li> </ul>			
	<ul style="list-style-type: none"> <li>■ Or damaged through force</li> </ul>			

# PERI Rental Criteria

## VARIO Accessories











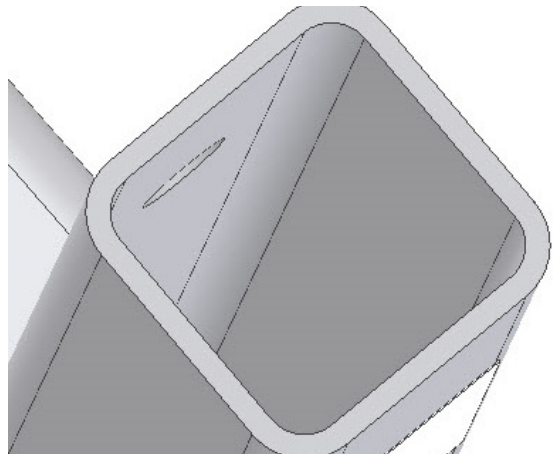

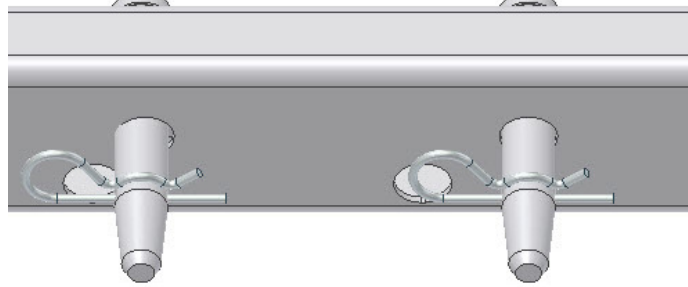

Girder Claw HB (024600)	Description	Instruction	Billing	Type
	<p><b>09.32 Bolt   Nut   Hook</b></p> <ul style="list-style-type: none"> <li>■ Missing</li> <li>■ Or damaged through force</li> </ul>	<p>  710249 (Bolt)   024090 (Nut)   024040 (Hook)         </p> <p>  710249 (Bolt)   024090 (Nut)   024040 (Hook)         </p>	<p>    </p>	<p>    </p>
	<p><b>09.33 Edge Girder Connector Bent</b></p>	<p>  710968 (Edge Girder Connector)         </p>	<p>  </p>	<p>  </p>

# PERI Rental Criteria

## VARIO Accessories











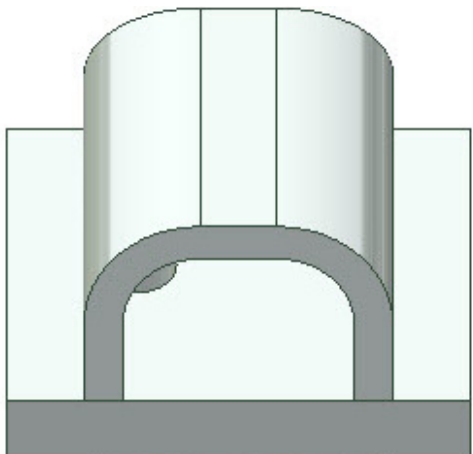

Handrail Holder SRU (104131)	Description	Instruction	Billing	Type
	<b>09.34 Tube bent</b>	<ul style="list-style-type: none"> <li data-bbox="846 566 1294 614">■ If possible </li> </ul>		
	<ul style="list-style-type: none"> <li data-bbox="846 710 1294 742">■ Or if not possible</li> </ul>			
	<b>09.35 Pin   Cotter pin</b>	<ul style="list-style-type: none"> <li data-bbox="846 1077 1294 1125">■ Missing  105400 (pin) 018060 (cotter pin)</li> </ul>		
	<ul style="list-style-type: none"> <li data-bbox="846 1220 1294 1252">■ Or damaged through force</li> </ul>	 105400 (pin) 018060 (cotter pin)		

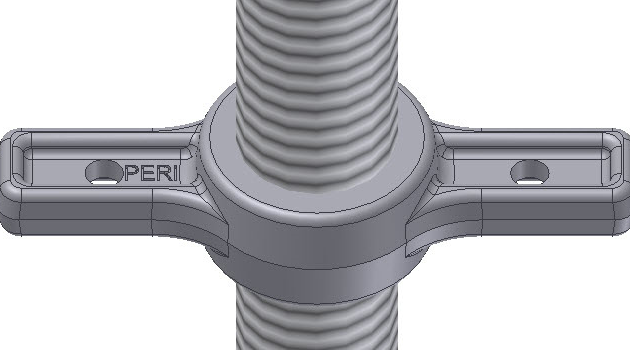
# PERI Rental Criteria

## VARIO Accessories



Spindle Head SRU (109630)	Description	Instruction	Billing	Type
	<b>09.36 Head bent</b>			
	<ul style="list-style-type: none"> <li>■ If possible</li> </ul>			
	<b>09.37 Cam nut</b>			
	<ul style="list-style-type: none"> <li>■ Missing</li> </ul>			
	<ul style="list-style-type: none"> <li>■ Or damaged through force</li> </ul>			

# PERI Rental Criteria

## VARIO Accessories



Bulkhead Tie (013240)	Description	Instruction	Billing	Type
	<b>09.38 Bent</b>			
	<ul style="list-style-type: none"> <li>■ If possible</li> </ul>			
	<ul style="list-style-type: none"> <li>■ Or if not possible</li> </ul>			
	<b>09.39 Thread not moveable</b>			
	<ul style="list-style-type: none"> <li>■ Worn</li> </ul>			
	<ul style="list-style-type: none"> <li>■ Or damaged through force</li> </ul>			



# PERI Rental Criteria

## VARIO Accessories



Lowering Wedge (024590; 117930)	Description	Instruction	Billing	Type
---------------------------------	-------------	-------------	---------	------

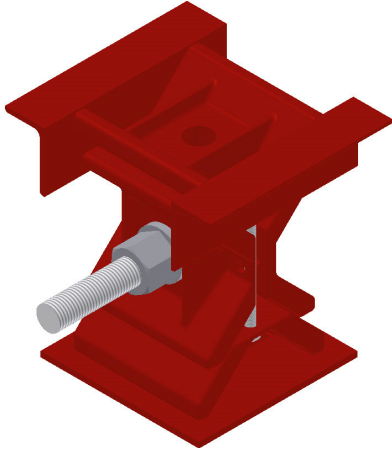

**09.40 Function not available**











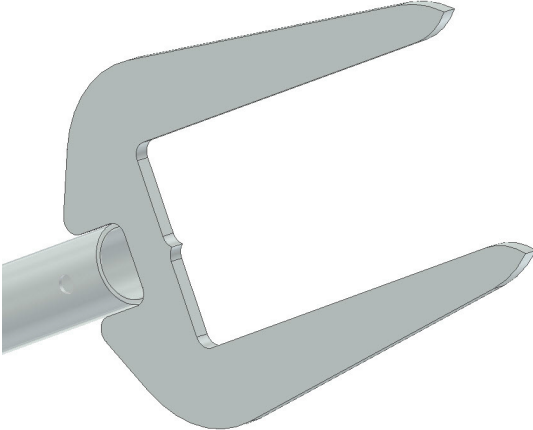



- Worn
- Or damaged through force



**09.41 Bent**

- If possible
- Or if not possible











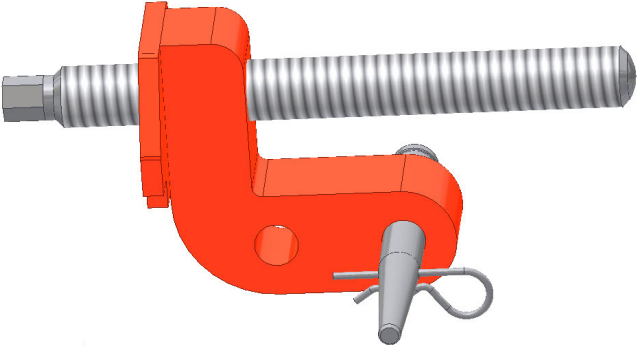

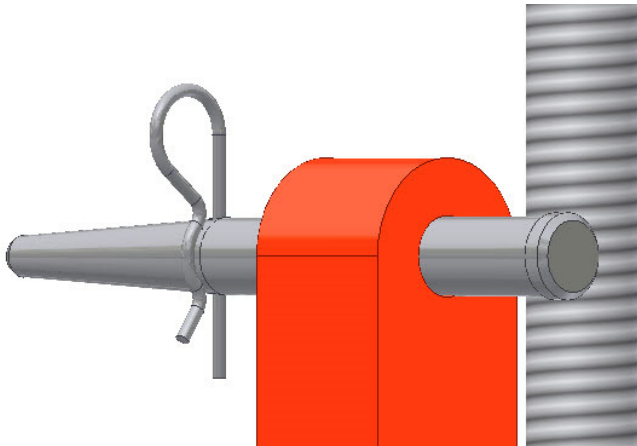

Errection Bar (070740)	Description	Instruction	Billing	Type
	<b>09.42 Bar bent</b>			
	■ If possible			
	■ Or if not possible			
	<hr/>			
	<b>09.43 Complete Errection bar bent</b>			
	■ If possible			
	■ Or if not possible			

# PERI Rental Criteria

## VARIO Accessories



















Adjusting Unit SRU (111135)	Description	Instruction	Billing	Type
	<b>09.44 Spindle</b>			
	<ul style="list-style-type: none"> <li>■ Worn</li> </ul>	 111132 (Spindle)		
	<ul style="list-style-type: none"> <li>■ Or damaged through force</li> </ul>	 111132 (Spindle)		
	<b>09.45 Pin   Cotter pin</b>			
	<ul style="list-style-type: none"> <li>■ Missing</li> </ul>	 104031 (Pin) 018060 (Cotter pin)		
	<ul style="list-style-type: none"> <li>■ Or damaged through force</li> </ul>	 104031 (Pin) 018060 (Cotter pin)		

# PERI Rental Criteria

## Glossary Icons



Icon	Significance	Icon	Significance	Icon	Significance
	Not OK – Scrap		Compensation (customer)		Optical damage– it’s permitted to handle out
	OK— Article stays in Rental Park		No compensation		Functional damage– it’s permitted to handle out
	It’s <b>not</b> permitted to handle out the article because of security aspects		Shorten the article		Functional damage– it’s <b>not</b> permitted to handle out
	Repair according to Working Instruction		Mark article		Statical damage– it’s <b>not</b> permitted to handle out
	Fix article cold		Replace defect components		
	Repair after local profitability calculation		Replace missing components		
	Clean the article				