

PERI Rental Criteria

MAXIMO

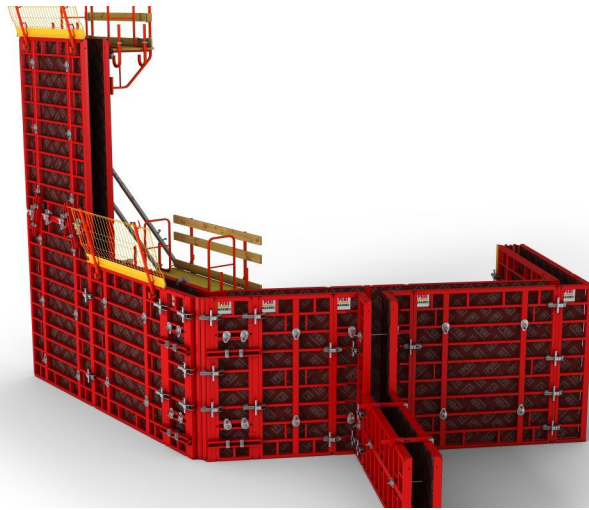

Contact

PERI GmbH
Formwork Scaffolding
Engineering
 P.O. Box 1264
 89264 Weissenhorn, Germany
 Phone +49 (0) 7309.950-0
 Fax +49 (0) 7309.951-0
 rental-criteria@peri.de

Content	Page
Frame	2
Articulated Corner	20
Shaft element	25
Wall thickness compensation	29
Reinforcement panel	39
Accessories	46
Platform	62
MXK	83
MXH	96

Changes	Date Initial	Page
New version	08/2015 fw	
MXK and MXH added	08/2016 fw	

PERI Rental Criteria

MAXIMO



MAXIMO Frame	No.	Name	Article number
--------------	-----	------	----------------

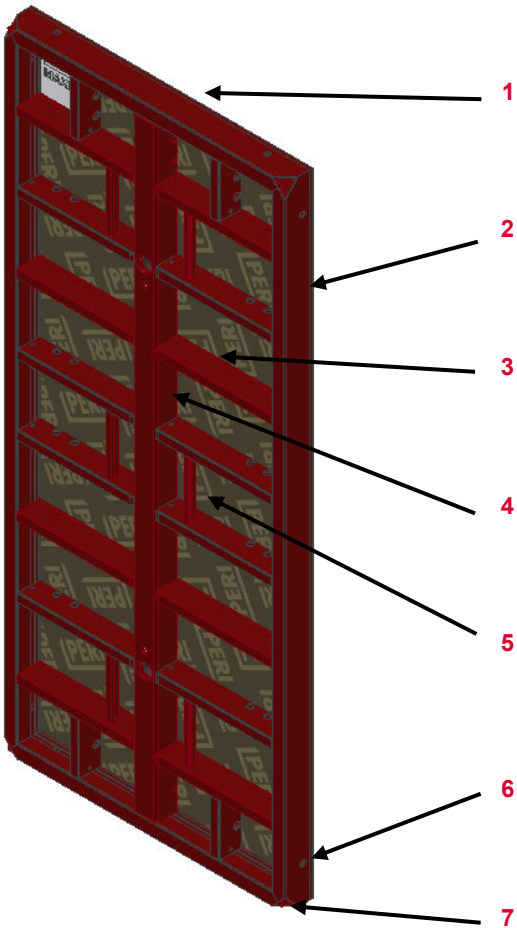

1	Front profile	
2	Length profile	
3	Brace	
4	Anchor Brace	
5	Exit tube	111999
6	Sleeve	750120
7	Levering corner	112337

PERI Rental Criteria

MAXIMO



Article	Article number
Element MX 15 330x270	116454
Element MX 15 330x 40	114426
Element MX 15 330x120	114248
Element MX 15 330x90	114258
Element MX 15 330x60	114445
Element MX 15 330x45	114452
Element MX 15 330x30	114457
Element MXM 15 330x60	114464
Element MX 15 270x240	112006
Element MX 15 270x120	112022
Element MX 15 270x90	112045
Element MX 15 270x60	112200
Element MX 15 270x45	112078

Article	Article number
Element MX 15 270x45	112078
Element MX 15 270x30	112090
Element MXM 15 270x60	112849
Element MX 15 120x240	112104
Element MX 15120x120	112143
Element MX 15 120x90	112152
Element MX 15 120x60	112221
Element MX 15 120x45	112232
Element MX 15 120x30	112239
Element MXM 15 120x60	117915

PERI Rental Criteria

MAXIMO



Article	Article number
Element MX 15 90x240	112115
Element MX 15 90x90	112252
Element MX 15 90x60	112259
Element MX 15 90x45	112265
Element MX 15 90x30	112271
Element MX 15 60x240	112126
Element MX 15 60x60	112280
Element MX 15 60x45	112286
Element MX 15 60x30	112292
Element MX 15 30x240	112133

Article	Article number

PERI Rental Criteria

MAXIMO



Article	Article number
Element MX 18, 330x240	124093
Element MX 18, 330x120	124126
Element MX 18, 330x90	124127
Element MX 18, 330x60	124128
Element MX 18, 330x45	124129
Element MX 18, 330x30	124130
Element MXM 18, 330x60	124163
Element MX 18, 330x270	124131
Element MX 18, 270x240	124132
Element MX 18, 270x120	124134
Element MX 18, 270x90	124138
Element MX 18, 270x60	124135
Element MX 18, 270x45	124136

Article	Article number
Element MX 18, 270x30	124137
Element MXM 18, 270x60	124188
Element MX 18, 120x240	124139
Element MX 18, 120x120	124142
Element MX 18, 120x90	124143
Element MX 18, 120x60	124144
Element MX 18, 120x45	124145
Element MX 18, 120x30	124146
Element MXM 18, 120x60	124189

PERI Rental Criteria MAXIMO



Article	Article number
Element MX 18, 90x240	124147
Element MX 18, 90x90	124148
Element MX 18, 90x60	124149
Element MX 18, 90x45	124150
Element MX 18, 90x30	124151
Element MX 18, 60x240	124157
Element MX 18, 60x60	124158
Element MX 18, 60x45	124160
Element MX 18, 60x30	124159
Element MX 18, 30x240	124162

Article	Article number

PERI Rental Criteria

MAXIMO















Article	Article number
Outer Corner MXA 120x35	112761
Outer Corner MXA 120x45	112830
Outer Corner MXA 270x35	112667
Outer Corner MXA 270x45	112806
Outer Corner MXA 330x35	114486
Outer Corner MXA 330x45	114478
Outer Corner MXA 60x35	112778
Outer Corner MXA 60x45	112837
Outer Corner MXA 90x35	126917
Outer Corner MXA 90x45	126923
Inner Corner MXI 330x60	114470
Inner Corner MXI 330x50/20	115338
Inner Corner MXI 270x60	112419

Article	Article number
Inner Corner MXI 270x50/20	115255
Inner Corner MXI 120x60	112689
Inner Corner MX 120x50/20	115299
Inner Corner MXI 90x60	112715
Inner Corner MXI 90x50/20	115307
Inner Corner MXI 60x60	112726
Inner Corner MXI 60x50/20	115315
Shaft corner MXSE 330	117913
Shaft corner MXSE 270	117914
Shaft corner MXSE 120	117915

PERI Rental Criteria

MAXIMO



















Frame	Description	Instruction	Billing Condition	Type
	<p>26.01 Profile parts or braces torn out</p>	 		
	<p>26.02 Front profile damaged</p> <ul style="list-style-type: none"> ■ Kink caused by lifting hook ■ Or damaged by force, rest of the frame in good condition 	<ul style="list-style-type: none">  Front profile  Front profile 	<ul style="list-style-type: none">  See table (p. 18)  See table (p. 18) 	<ul style="list-style-type: none">  

PERI Rental Criteria

MAXIMO















Frame	Description	Instruction	Billing Condition	Type
	26.03 Length profile deformed			
	<ul style="list-style-type: none"> ■ Kink caused by lifting hook ■ Or damaged by force 	 		
	26.04 Holes in the profile			
	<ul style="list-style-type: none"> ■ $\leq \text{Ø } 3 \text{ cm}$ 			088028 
	<ul style="list-style-type: none"> ■ Or $> \text{Ø } 3 \text{ cm}$ in length- or Anchor profile 	 		
<ul style="list-style-type: none"> ■ Or $> \text{Ø } 3 \text{ cm}$ in front profile, brace or exit tube 			See table (p. 19) 	

PERI Rental Criteria

MAXIMO











Frame	Description	Instruction	Billing Condition	Type
	26.05 Kink in brace		 See table (p. 19)	
	26.06 Sleeve in brace damaged <ul style="list-style-type: none"> ■ If bending is possible  ■ Or if bending is impossible  Strut ■ Or pieces torn out  Strut 	 088244 	 See table (p. 19) 	 See table (p. 19) 

PERI Rental Criteria

MAXIMO





















Frame	Description	Instruction	Billing Condition	Type
	<p>26.07 Element bent diagonally</p> <ul style="list-style-type: none"> ■ > 6 mm 			
	<p>26.08 Element bent</p> <ul style="list-style-type: none"> ■ > 8 mm 			

PERI Rental Criteria

MAXIMO













Frame	Description	Instruction	Billing Condition	Type
	26.09 Dent in profile <ul style="list-style-type: none"> ■ ≤ 5 mm depth 	 		
	<ul style="list-style-type: none"> ■ Or > 5 mm depth 			088027 
	26.10 Dent in profile edge <ul style="list-style-type: none"> ■ ≤ 3 mm 	 		
	<ul style="list-style-type: none"> ■ Or > 3 mm until ≤ 10 mm 			088236 
	<ul style="list-style-type: none"> ■ Or > 10 mm 	 Remove plywood		088236 

PERI Rental Criteria

MAXIMO











Frame	Description	Instruction	Billing Condition	Type
	<p>26.11 Crack in the outside welding</p>		 088028	
	<p>26.12 Crack in the profile edge</p> <ul style="list-style-type: none"> ■ With damage in the profile edge ■ Or without damage of the profile edge 	 	 088028 	 

PERI Rental Criteria

MAXIMO











Frame	Description	Instruction	Billing Condition	Type
	<p>26.13 Levering Corner damaged useless</p>		 088056	
	<p>26.14 Sleeve damaged, missing</p>		 088002	

PERI Rental Criteria

MAXIMO



Frame	Description	Instruction	Billing Condition	Type
	<p>26.15 Hole in frame caused by rust</p> <ul style="list-style-type: none"> ■ Test with 300 g hammer and peen 	 		
	<p>26.16 Ring thread damaged</p> <ul style="list-style-type: none"> ■ Test with torque wrench and 110 Nm 	 <p>125214 (riveting nut)</p>		

PERI Rental Criteria

MAXIMO



Corner	Description	Instruction	Billing Condition	Type
--------	-------------	-------------	-------------------	------

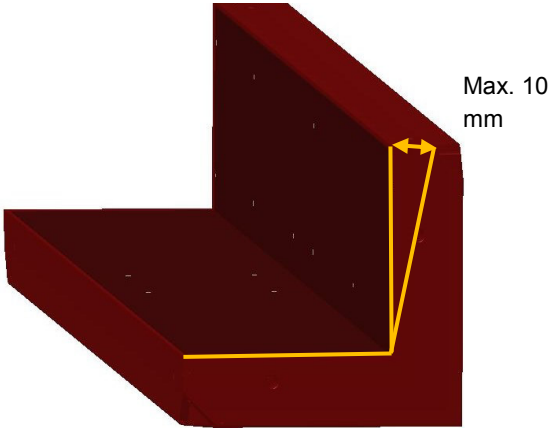

26.17 Outer corner bent

- Bent > 10 mm



26.18 Inner corner bent

- Bent > 10 mm



PERI Rental Criteria

MAXIMO



Washer (123603; 123604)	Description	Instruction	Billing Condition	Type
-------------------------	-------------	-------------	-------------------	------

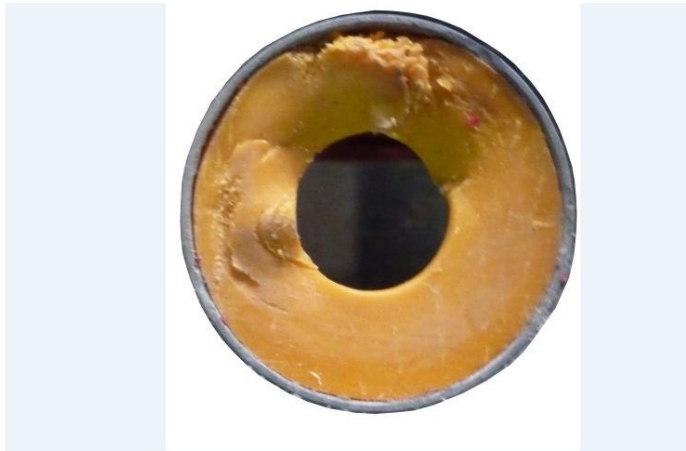

26.19 Rubber damaged



088033



26.20 Anchor soiled with concrete



Afterwards lubricate with PERI Clean



088073



PERI Rental Criteria

MAXIMO



Article	Front profile	
	Spare part	Service article number
Front profile 30	109106	088049
Front profile 45	112065	088050
Front profile 60	109031	088051
Front profile 90	109023	088052
Front profile 120	109021	088053
Front profile 240	745051	088054
Front profile 270	745050	088055

PERI Rental Criteria

MAXIMO



Article	Brace	
	Spare part	Service article number
Strut 18	745357	088038
Strut 19	112479	088039
Strut 22	745356	088040
Strut 33	112511	088041
Strut 34	112500	088042
Strut 43	745355	088043
Strut 48	745354	088044
Strut 49	112508	088045
Strut 78	745352	088046
Strut 122	745350	088047
Strut 140	116461	088048
Strut 108	745351	088230
Strut 60	745353	088232

PERI Rental Criteria

MAXIMO



MAXIMO Articulated corner	No.	Name	Article number
---------------------------	-----	------	----------------

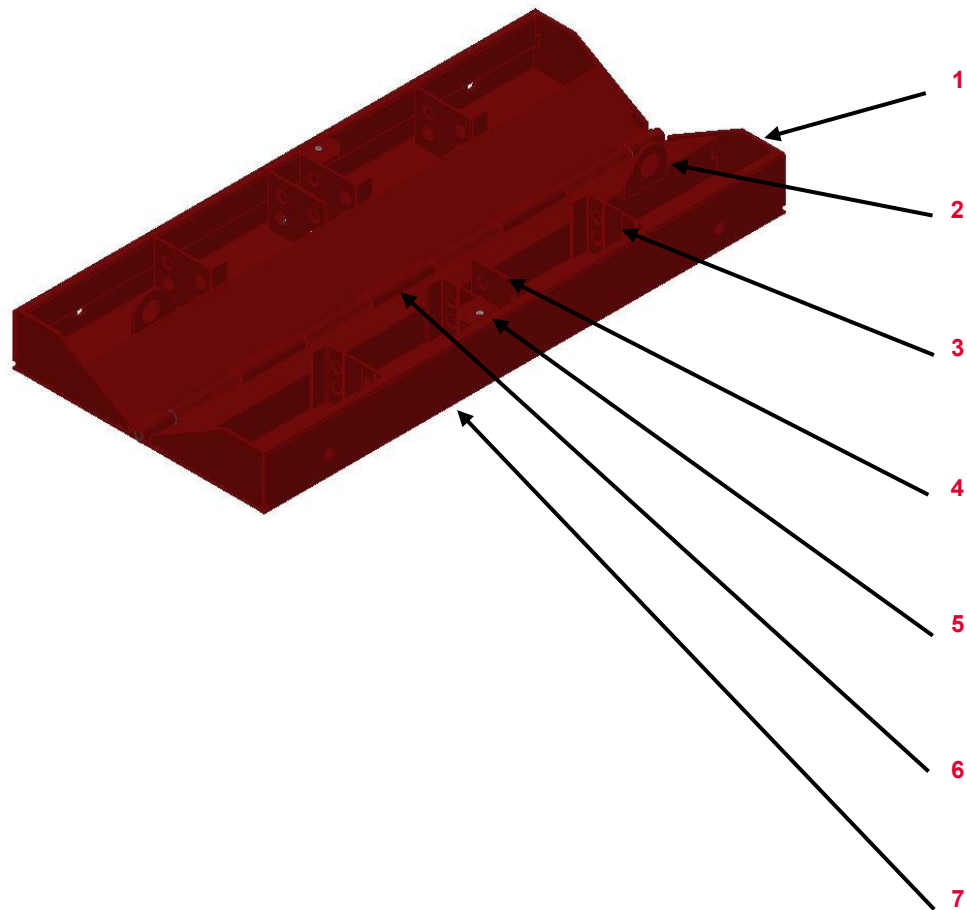

1	Cover plate	111751
2	Mounting eye	111709
3	„Strebenprofil“	111708
4	Bearing plate	114105
5	„Gewindelasche“	113210
6	Hinge	
7	Concrete surface	

Valid for	Article number
Articulated corner MXGA 120	111850
Articulated corner MXGA 270	111872
Articulated corner MXGA 330	114607
Articulated corner MXGI 120	113246
Articulated corner MXGI 270	113203
Articulated corner MXGI 330	114583
Articulated corner MXGI 18 120	124201
Articulated corner MXGI 18 270	124200
Articulated corner MXGI 18 330	124202

PERI Rental Criteria

MAXIMO



Dents	Description	Instruction	Billing Condition	Type
-------	-------------	-------------	-------------------	------



26.21 Dent or kink in concrete surface

■ ≤ 3 mm



■ Or > 3 mm



088027

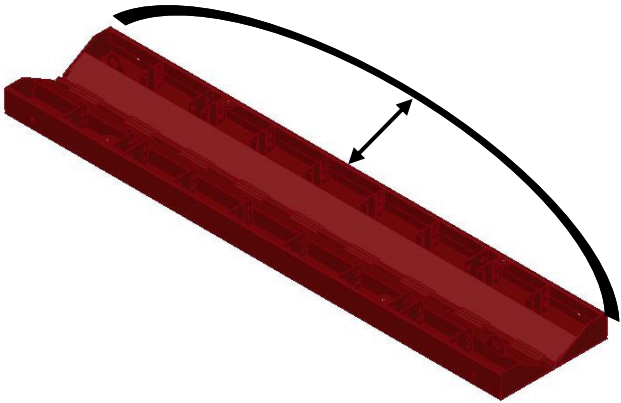

26.22 Frame dent





















■ > 8 mm



PERI Rental Criteria

MAXIMO





Plates	Description	Instruction	Billing Condition	Type
	26.23 Bearing profile or „Strebenprofil“ bent			
	<ul style="list-style-type: none"> ■ If bending is possible 			
	<ul style="list-style-type: none"> ■ Or if bending is impossible 			
	<ul style="list-style-type: none"> ■ Or damaged welding 			
	26.24 Mounting eye bent			
	<ul style="list-style-type: none"> ■ If bending is possible 			
	<ul style="list-style-type: none"> ■ Or bending is impossible 			
	<ul style="list-style-type: none"> ■ Or damaged welding 			

PERI Rental Criteria

MAXIMO



Plates	Description	Instruction	Billing Condition	Type
	26.25 Thread plate			
	■ Bent		088244	
	■ Or crack in welding			
	■ Or torn out			
	26.26 Cover plate deformed or torn out			
	■ > 3 mm		088244	
	■ Or bending not possible	111842 (MXGA) 111751 (MXGI)		

PERI Rental Criteria

MAXIMO



Function	Description	Instruction	Billing Condition	Type
	26.27 Function			
	<ul style="list-style-type: none"> ■ Element moves hardly 	Afterwards oil the hinge		
	<ul style="list-style-type: none"> ■ Function not available 			
	<ul style="list-style-type: none"> ■ Function not available after cleaning and repair 			
	26.28 Element bent diagonally			
	<ul style="list-style-type: none"> ■ > 5 mm 			

PERI Rental Criteria

MAXIMO



MAXIMO Shaft corner MXSE			
No.	Name	Article number	

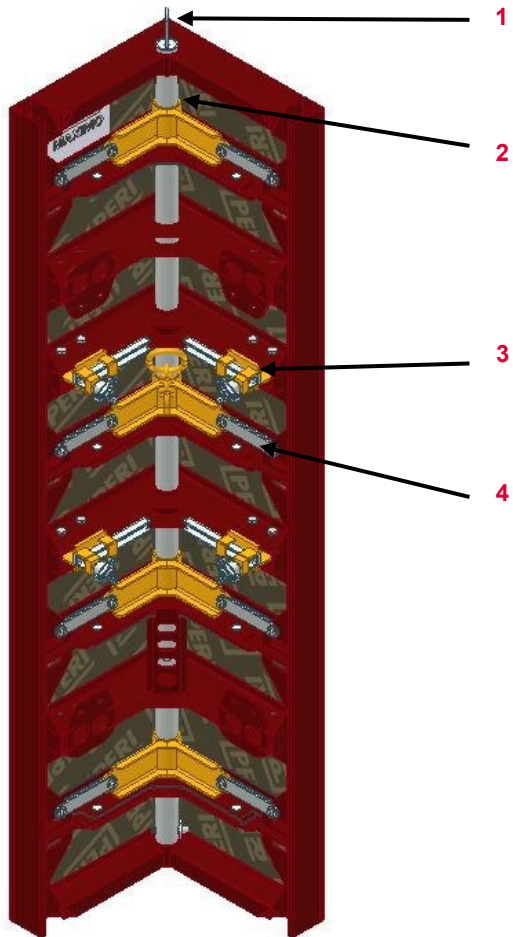

1	Tension ledge	118140	
2	Draw bar	118182	
3	Position ledge	126263	
4	Lever MXSE	118136	

Valid for	Article number
Shaft element MXSE 120	117915
Shaft element MXSE 270	117914
Shaft element MXSE 330	117913
Shaft element MXSE 18, 120	125288
Shaft element MXSE 18, 270	125286
Shaft element MXSE 18, 330	125284

PERI Rental Criteria

MAXIMO





Frame	Description	Instruction	Billing Condition	Type
	<p>26.29 Frame and exterior brace damaged, difficult to dismantle</p>			
	<p>26.30 Plywood protrudes at profile</p>	<p>Remove or adjust aluminium strip, so that profile and plywood are levelled</p>		

PERI Rental Criteria

MAXIMO







Shaft element	Description	Instruction	Billing Condition	Type
	26.31 Draw bar crack in welding		088061	
	26.32 Lever MXSE bent			
	<ul style="list-style-type: none"> ■ If bending is possible ■ Or if not possible 	<ul style="list-style-type: none"> 	<ul style="list-style-type: none"> 088244 118136 (Lever) 	<ul style="list-style-type: none">

PERI Rental Criteria

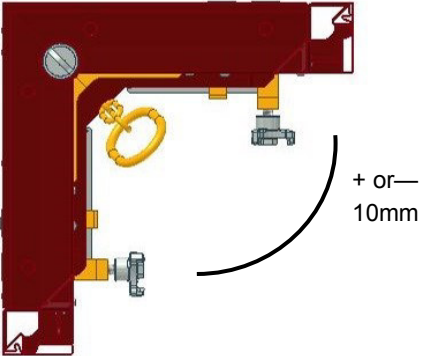
MAXIMO



Shaft element	Description	Instruction	Billing Condition	Type
	<p>26.33 Frame bent</p> <ul style="list-style-type: none"> ■ > 10 mm 			

PERI Rental Criteria

MAXIMO



MX Wall thickness compensation aluminium	No.	Name	Article number
--	-----	------	----------------

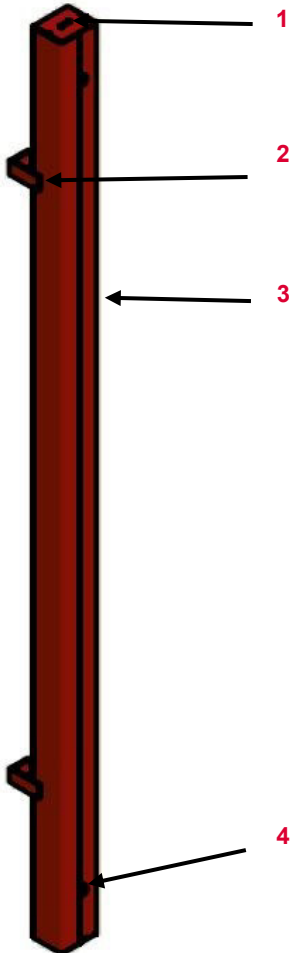



1	Insert plate	101959
2	Profile	
3	Concrete surface	
4	Tube WDA	

Valid for	Article number
Wall thickness compensation WDA MX 120x10 Alu	114142
Wall thickness compensation WDA MX 270x10 Alu	114128
Wall thickness compensation WDA MX 330x10 Alu	114394

PERI Rental Criteria

MAXIMO

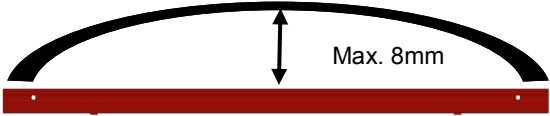

Compensation	Description	Instruction	Billing Condition	Type
	26.34 Compensation bent			
	<ul style="list-style-type: none"> ■ > 8 mm 			
	26.35 Dent in concrete surface			
	<ul style="list-style-type: none"> ■ ≤ 3 mm 			
	<ul style="list-style-type: none"> ■ Or > 3 mm < 10 mm 		088244	
<ul style="list-style-type: none"> ■ Or > 10 mm 				

PERI Rental Criteria

MAXIMO



Compensation	Description	Instruction	Billing Condition	Type
--------------	-------------	-------------	-------------------	------

26.36 Deformed insert plate (without damage of the welding)

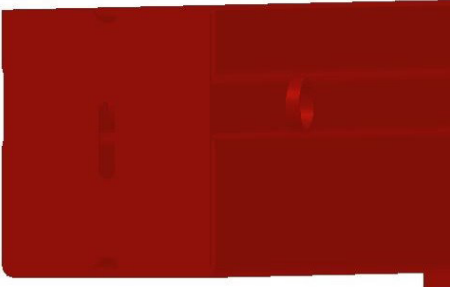

26.37 Deformed insert plate (with damage of the welding)











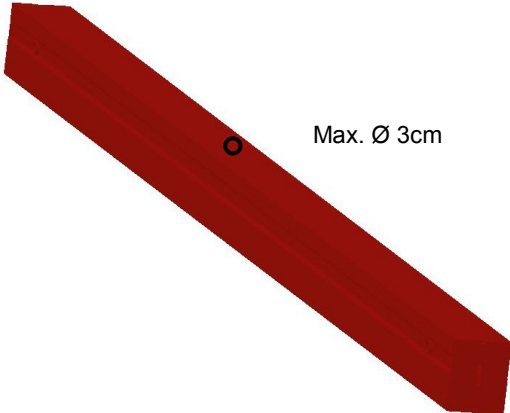

088001

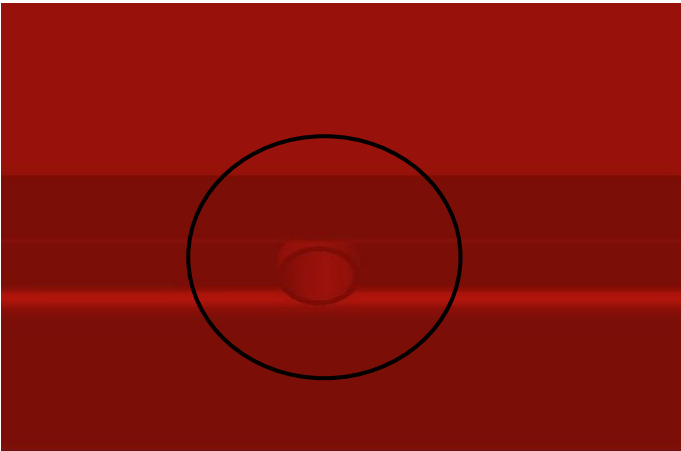

PERI Rental Criteria

MAXIMO











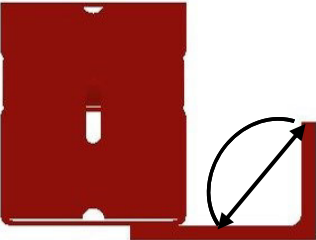

Compensation	Description	Instruction	Billing Condition	Type
	<p>26.38 Hole in concrete surface</p> <ul style="list-style-type: none"> ■ $\text{Ø} \leq 3 \text{ cm}$ ■ Or $\text{Ø} > 3 \text{ cm}$ 	<ul style="list-style-type: none">   	<ul style="list-style-type: none">  088028  	<ul style="list-style-type: none">  
	<p>26.39 Damaged/ useless tube</p>	<ul style="list-style-type: none">  	<ul style="list-style-type: none">  	<ul style="list-style-type: none"> 

PERI Rental Criteria

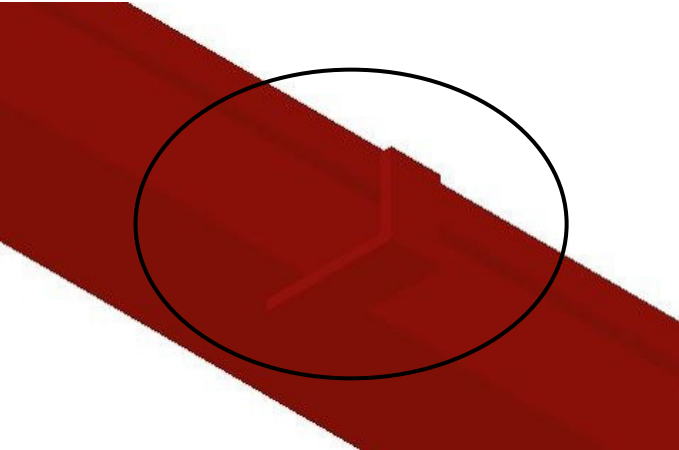
MAXIMO



Profile	Description	Instruction	Billing Condition	Type
	26.40 Profile bent			
	<ul style="list-style-type: none"> ■ ≤ 10 mm ■ Or > 10 mm 	<ul style="list-style-type: none">   740781 (WDA 120) 740776 (WDA 270 + 330) 	<ul style="list-style-type: none">  088244  088000 	<ul style="list-style-type: none">  
	26.41 Profile missing	<ul style="list-style-type: none">  740781 (WDA 120) 740776 (WDA 270 + 330) 	<ul style="list-style-type: none">  088000 	<ul style="list-style-type: none"> 

PERI Rental Criteria

MAXIMO



MX Wall thickness compensation steel	No.	Name	Article number
--------------------------------------	-----	------	----------------

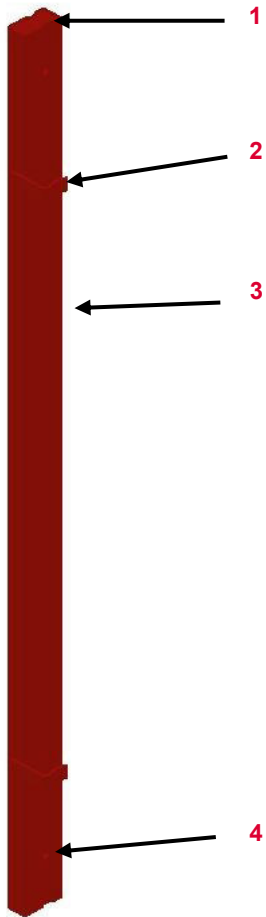











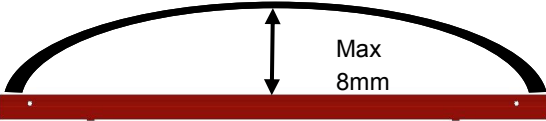

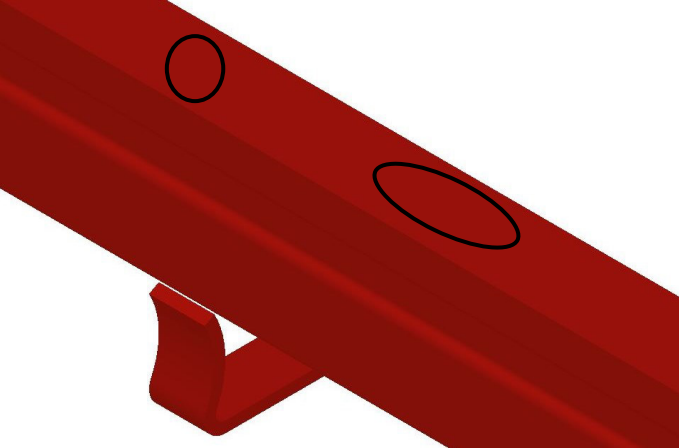

1	Insert plate
2	Profile
3	Concrete surface
4	Sleeve

Valid for	Article number
Wall thickness compensation WDA MX 330x6	114846
Wall thickness compensation WDA MX 330x5	114826
Wall thickness compensation WDA MX 330x4	114842
Wall thickness compensation WDA MX 270x6	114174
Wall thickness compensation WDA MX 270x5	114186
Wall thickness compensation WDA MX 270x4	114165
Wall thickness compensation WDA MX 120x6	114181
Wall thickness compensation WDA MX 120x5	114191
Wall thickness compensation WDA MX 120x4	114212

PERI Rental Criteria

MAXIMO









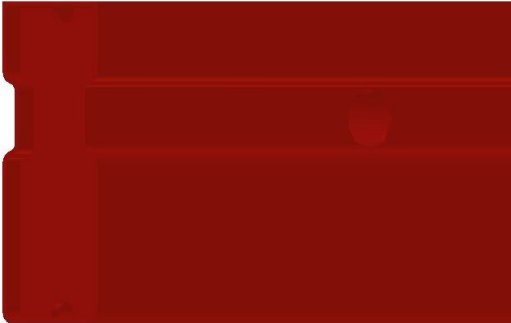

Compensation	Description	Instruction	Billing Condition	Type
	26.42 Compensation bent			
	<ul style="list-style-type: none"> ■ > 8 mm 			
	26.43 Dent in concrete surface			
	<ul style="list-style-type: none"> ■ ≤ 3 mm 			
	<ul style="list-style-type: none"> ■ Or > 3 mm until ≤ 10 mm 			
	<ul style="list-style-type: none"> ■ Or > 10 mm 			

PERI Rental Criteria

MAXIMO







Compensation	Description	Instruction	Billing Condition	Type
	<p>26.44 Deformed insert plate (without damage of the welding))</p>			
	<p>26.45 Deformed insert plate (with damage of the welding)</p>		 088001	

PERI Rental Criteria

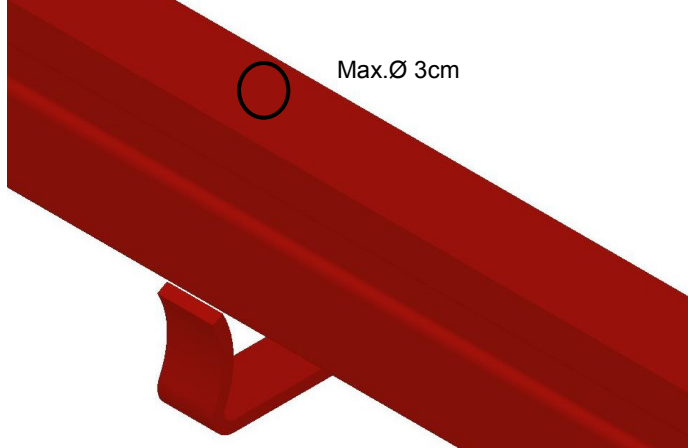
MAXIMO











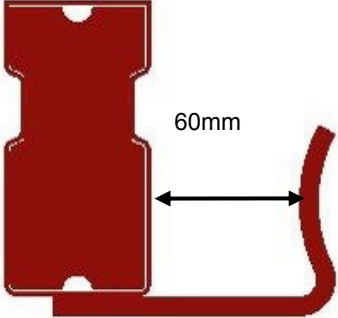

Compensation	Description	Instruction	Billing Condition	Type
	<p>26.46 Hole in concrete surface</p> <ul style="list-style-type: none"> ■ $\varnothing \leq 3 \text{ cm}$ ■ Or $\varnothing > 3 \text{ cm}$ 	<ul style="list-style-type: none">   	<ul style="list-style-type: none">  088028  	<ul style="list-style-type: none">  
	<p>26.47 Sleeve damaged/ useless</p>	<ul style="list-style-type: none">  	<ul style="list-style-type: none">  	<ul style="list-style-type: none"> 

PERI Rental Criteria

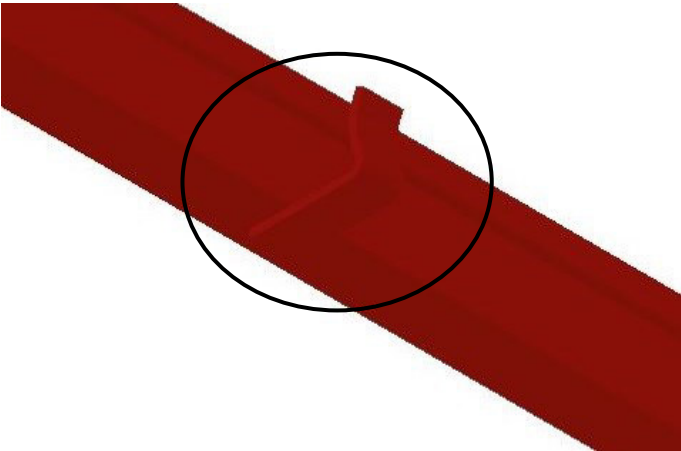
MAXIMO



Profile	Description	Instruction	Billing Condition	Type
	26.48 Profile bent			
	<ul style="list-style-type: none"> ■ ≤ 10 mm ■ Or > 10 mm 	 	 088244  088164	 
	26.49 Profile missing		 088164	

PERI Rental Criteria

MAXIMO



Reinforcement panel AT

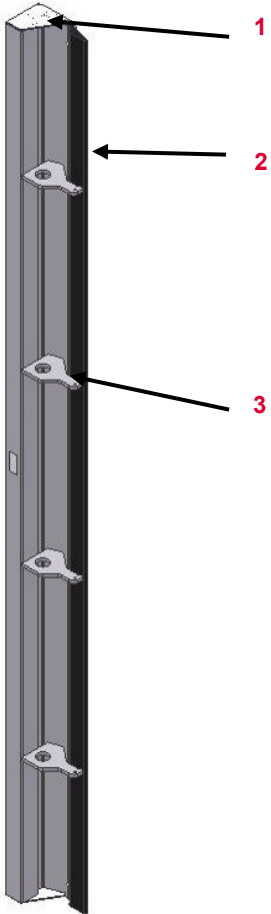









No.	Name	Article number
1	Cover plate	100782
2	Sealing profile	
3	Hook	100781

Valid for	Article number
Reinforcement panel TRIO AT 270x5	105953
Reinforcement panel TRIO AT 270x3	023060
Reinforcement panel TRIO AT 120x5	105978
Reinforcement panel TRIO AT 120x3	023067

PERI Rental Criteria

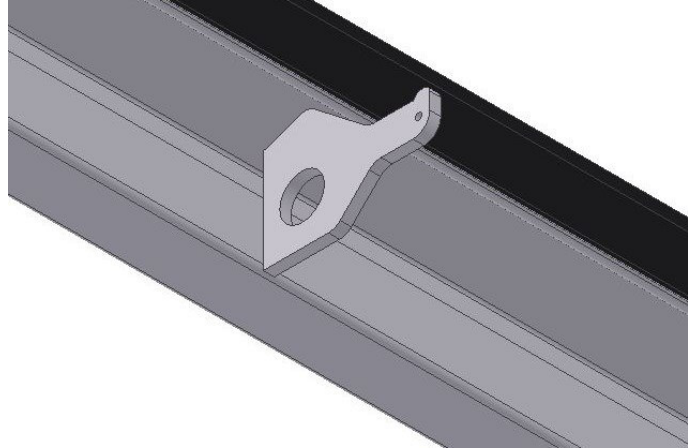
MAXIMO











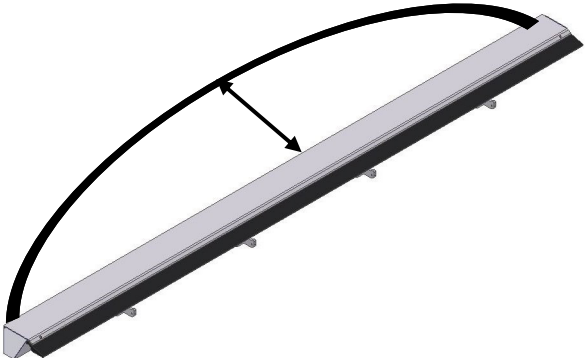

Profile	Description	Instruction	Billing Condition	Type
	<p>26.50 Sealing profile cut or torn</p> <ul style="list-style-type: none"> ■ > 3 mm depth 			
	<p>26.51 Crack in hook or missing</p>		 088154	

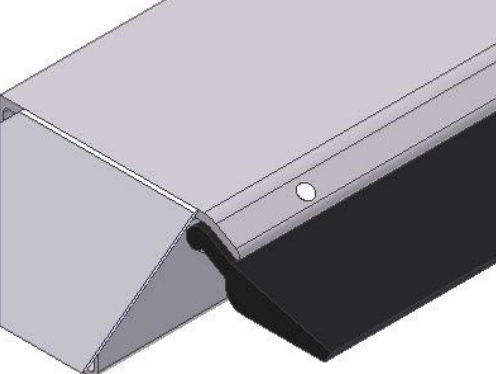
PERI Rental Criteria

MAXIMO



Profile	Description	Instruction	Billing Condition	Type
	<p>26.52 Bent profile</p> <ul style="list-style-type: none"> ■ > 8 mm 			
	<p>26.53 Cover plate damaged</p> <ul style="list-style-type: none"> ■ > 3 mm until \leq 10 mm 		 088244	
	<ul style="list-style-type: none"> ■ Or > 10 mm 		 088151	

Reinforcement panel MT	Nr.	Bezeichnung	Artikelnummer
------------------------	-----	-------------	---------------

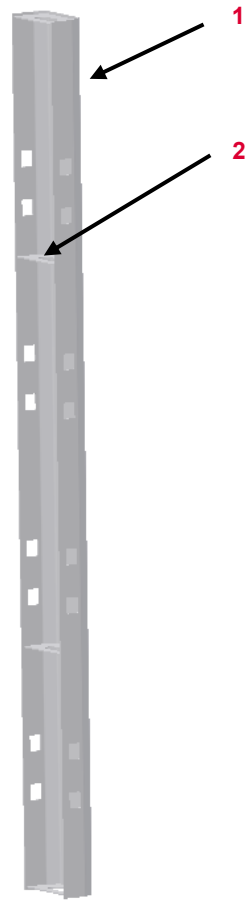









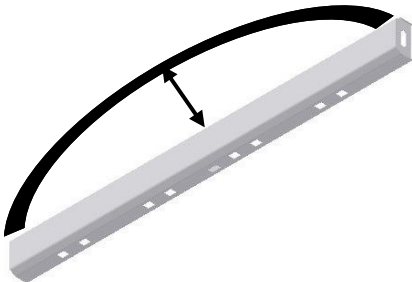

1	Profile
2	Inside plate

Valid for	Article number
Reinforcement panel TRIO MT 270x35/36	023065
Reinforcement panel TRIO MT 270x30	023064
Reinforcement panel TRIO MT 270x24/25	023062
Reinforcement panel TRIO MT 270x20	023061
Reinforcement panel TRIO MT 120x35/36	023072
Reinforcement panel TRIO MT 120x30	023071
Reinforcement panel TRIO MT 120x24/25	023069
Reinforcement panel TRIO MT 120x20	023068

PERI Rental Criteria

MAXIMO



Panel MT	Description	Instruction	Billing Condition	Type
	26.54 Panel dent, deformed <ul style="list-style-type: none"> ■ > 8 mm 			
	26.55 Inner plate damaged/ bent <ul style="list-style-type: none"> ■ Without damage of the welding ■ Or with damage of the welding 	 	 088244 	 

PERI Rental Criteria

MAXIMO



Reinforcement panel MTF

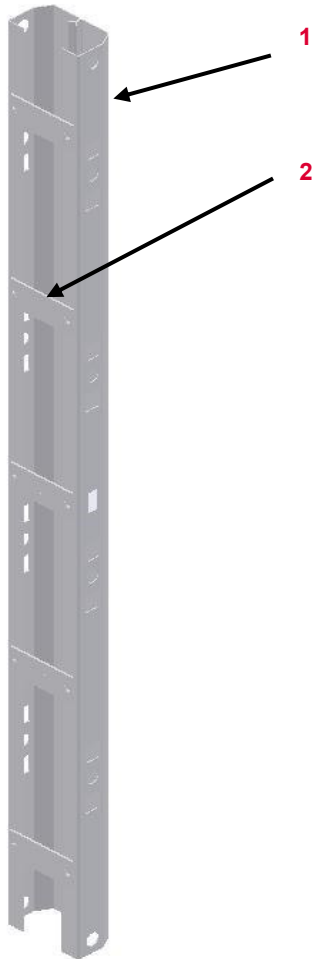







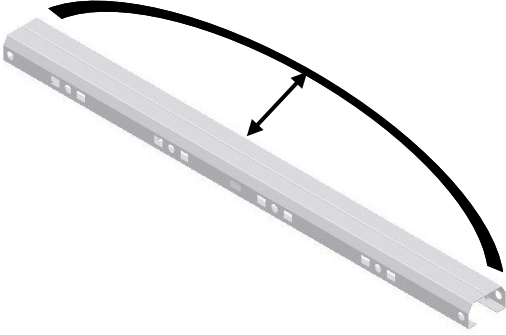

No.	Name	Article number
1	Profile	
2	Plate	

Valid for	Article number
Reinforcement panel TRIO MTF 270x35/36	023076
Reinforcement panel TRIO MTF 270x30	023077
Reinforcement panel TRIO MTF 270x24/25	023075
Reinforcement panel TRIO MTF 270x20	023074
Reinforcement panel TRIO MTF 120x35/36	023079
Reinforcement panel TRIO MTF 120x30	023078
Reinforcement panel TRIO MTF 120x24/25	023080
Reinforcement panel TRIO MTF 120x20	023081

PERI Rental Criteria

MAXIMO



Panel MTF	Description	Instruction	Billing Condition	Type
	<p>26.56 Panel dent</p> <ul style="list-style-type: none"> ■ > 8 mm 			
	<p>26.57 Deformed/ missing plates</p>			

PERI Rental Criteria

MAXIMO



Filler profile	No.	Name	Article number
----------------	-----	------	----------------

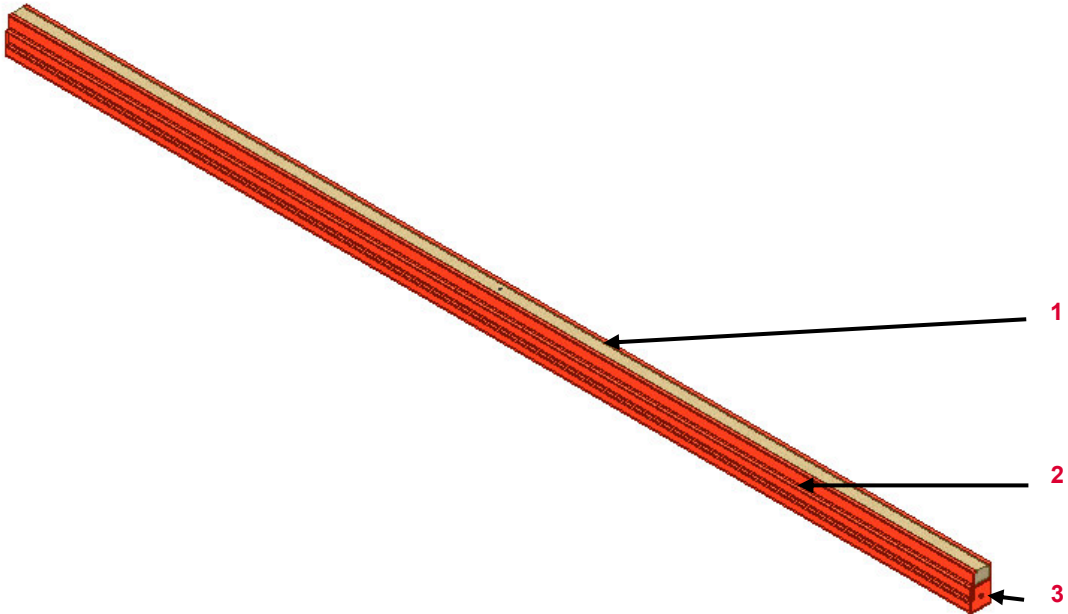















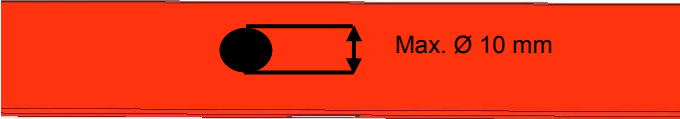

- 1 Wood
- 2 Profile
- 3 Cover plate

Valid for	Article number
Filler profile TPP 120 Alu	101823
Filler profile TPP 270 Alu	101813
Filler profile TPP 330 Alu	101829

PERI Rental Criteria

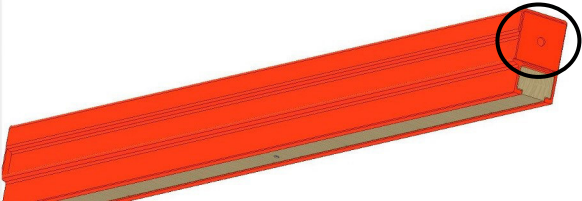
MAXIMO











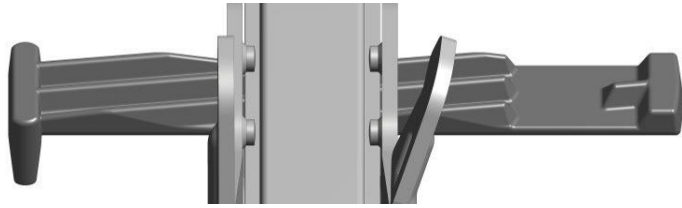





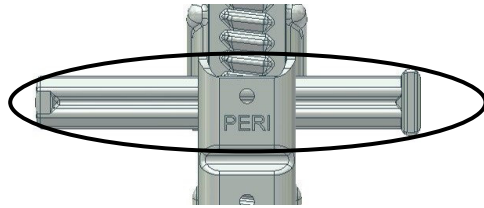

Filler profile	Description	Instruction	Billing Condition	Type
	26.58 Worn wood			
	26.59 Profile dent <ul style="list-style-type: none"> ■ > 8 mm 			
	26.60 Hole in profile <ul style="list-style-type: none"> ■ Ø > 10 mm 	 		
	26.61 Deformed cover plate			

PERI Rental Criteria

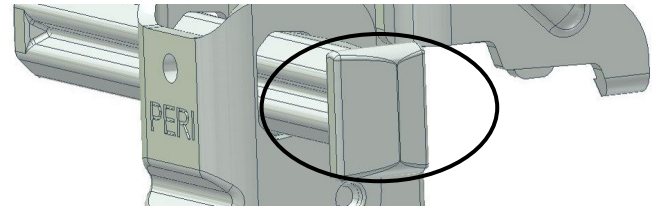
MAXIMO



Alignment Coupler BFD (023500)	Description	Instruction	Billing Condition	Type
	<p>26.62 Bent tie claw</p>		 088244	
	<p>26.63 Coupler fall apart</p>		 088032	
	<p>26.64 Wedge bent/ useless</p>	 		
	<p>26.65 Crack in hitting surface</p>	 		

PERI Rental Criteria

MAXIMO



MX Tie	No.	Name	Article number
--------	-----	------	----------------

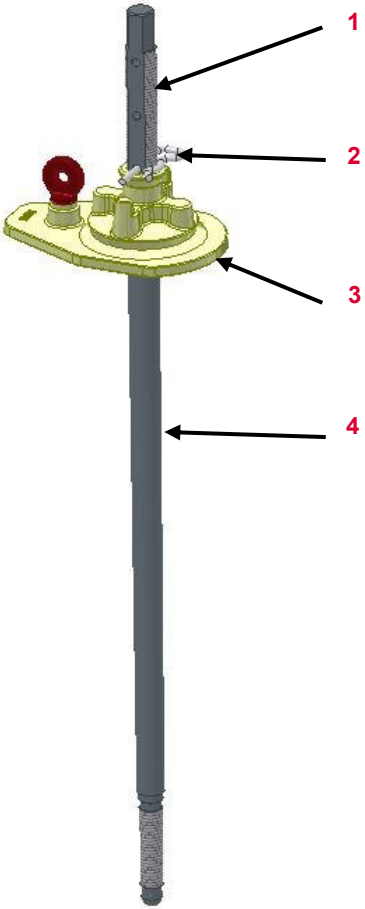













1	Thread	
2	Cotter pin MX	113256
3	Anchor plate with nut	123910
4	Anchor tie	

Valid for	Article number
MX 15 Tie 15-25	113847
MX 15 Tie 20-30	112387
MX 15 Tie 30-40	112464
MX 18 Tie 15-25	123901
MX 18 Tie 20-30	123902
MX 18 Tie 30-40	123903
MX 18 Tie 40-50	123904
MX 18 Tie 50-60	123905

PERI Rental Criteria

MAXIMO











MAXIMO Anchor	Description	Instruction	Billing Condition	Type
	26.66 Soiled thread		 088075	
	26.67 Separated parts		 088075	
	26.68 Damaged thread		 088075	

PERI Rental Criteria

MAXIMO















MX Wignnut (112386, 123900)	Description	Instruction	Billing Condition	Type
	<p>26.69 Deformed/ missing dowel pins</p>			
	<p>26.70 Deformed sleeve</p>			

PERI Rental Criteria

MAXIMO



Tie spanner MX15 (116841)	Description	Instruction	Billing Condition	Type
	<p>26.71 Hexagonal nut fallen out (Tie spanner of 2nd generation)</p>			
	<p>26.72 Hexagonal insert slips while tightening, because it has been oiled or greased (Tie spanner of 2nd generation)</p>	 <p>Dismount hexagonal insert and thorough cleaning and degreasing of the friction surfaces</p>		
	<p>26.73 Damaged spring</p>			

PERI Rental Criteria

MAXIMO



Bulkhead tie MX DW20 (115640)	Description	Instruction	Billing Condition	Type
-------------------------------	-------------	-------------	-------------------	------

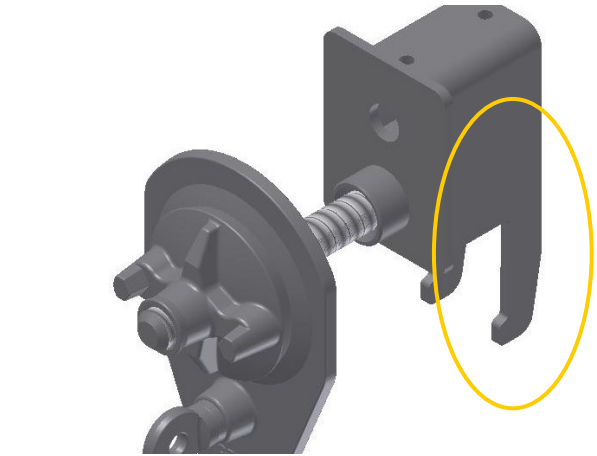

26.74 Deformed claws



088244

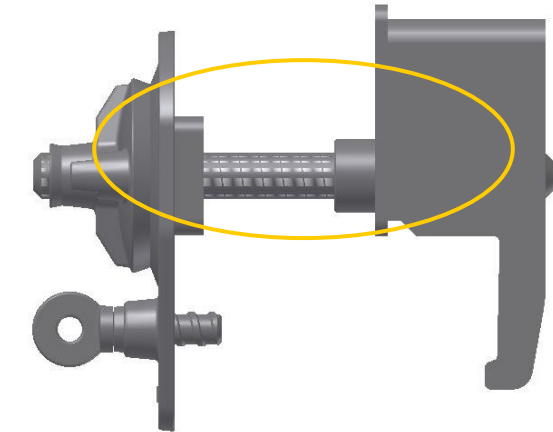









26.75 Soiled thread



PERI Rental Criteria

MAXIMO











MAR (124941; 124942)	Description	Instruction	Billing Condition	Type
	<p>26.76 Double hook bent</p>		 088035	
	<p>26.77 Double hook broken</p>		 088035	

PERI Rental Criteria

MAXIMO















MAR (124941; 124942)	Description	Instruction	Billing Condition	Type
	<p>26.78 Profile bent</p>		 088244	
	<p>26.79 Guide roller deformed</p>	 124940 (guide roller)	 088076	

PERI Rental Criteria

MAXIMO



TRIO prop connector (023660)	Description	Instruction	Billing Condition	Type
	<p>26.80 Crack in welding</p>			
	<p>26.81 Bent deformed</p>		 088244	
	<p>26.82 Broken wingnut</p>	 030190 (wingnut)	 088541	

PERI Rental Criteria

MAXIMO



Tension and Compensation device (123842; 115350)	No.	Name	Article number
--	-----	------	----------------

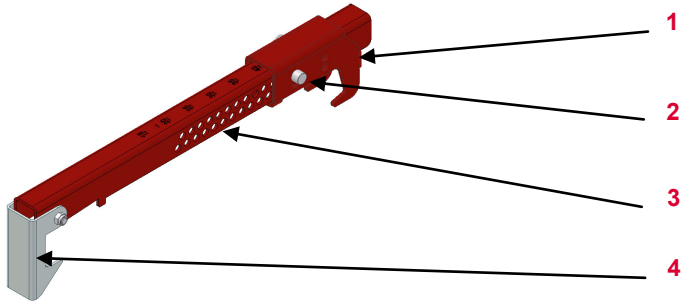

1	„Einhängeschuh“	115349
2	Bolt D=12	115331
3	„Abstandsschiene“	123841
4	„Sicherungshaken“	114390

Tension and Compensation device	Description	Instruction	Billing Condition	Type
---------------------------------	-------------	-------------	-------------------	------

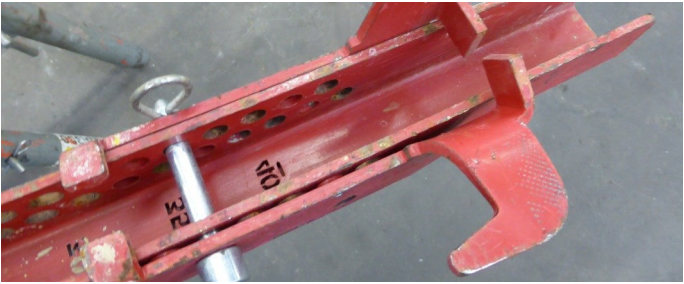

26.83 Bent claw			088244	
-----------------	--	--	--------	--







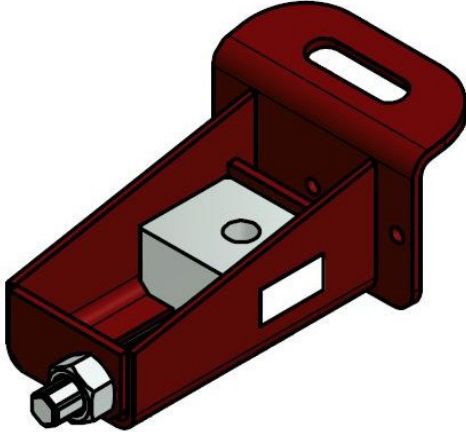

26.84 Stake holes cut in				
--------------------------	--	--	--	--

PERI Rental Criteria

MAXIMO

















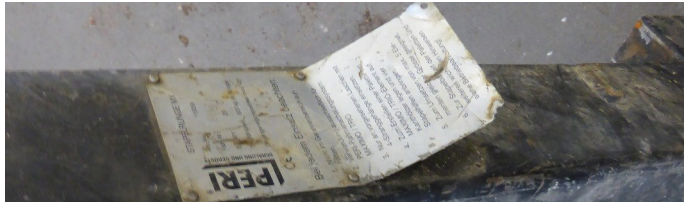

Adjusting bracket MX (101633)	Description	Instruction	Billing Condition	Type
	<p>26.85 Bent parts</p>		 088244	
	<p>26.86 Soiled thread</p>	 Afterwards test of the function		

PERI Rental Criteria

MAXIMO











Stacking device MX (115058)	Description	Instruction	Billing Condition	Type
	<p>26.87 Bended profile</p>		 088244	
	<p>26.88 Crack in welding</p>			
	<p>26.89 Unreadable, missing type plate</p>		 088037	
	<p>26.90 Bended device</p>		 088244	

PERI Rental Criteria

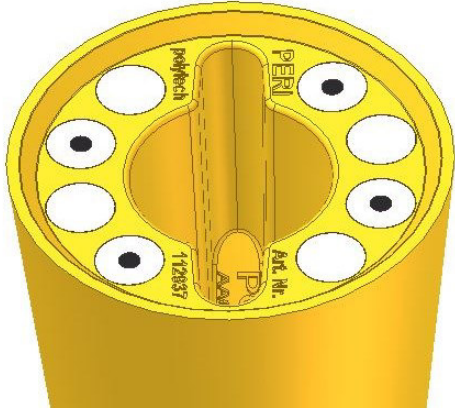
MAXIMO



Sealing cone (112937; 127425)	Description	Instruction	Billing Condition	Type
	<p>26.91 Damage at the plastic</p>			
	<p>26.92 Soiled with concrete</p>	 <p>Afterwards lubricate with PERI Clean</p>		

PERI Rental Criteria

MAXIMO



Magnetkonusschlüssel (126696)	Description	Instruction	Billing Condition	Type
-------------------------------	-------------	-------------	-------------------	------

26.93 Bent magnet core spanner

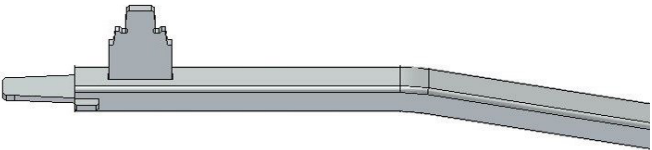

26.94 Bent head



088244

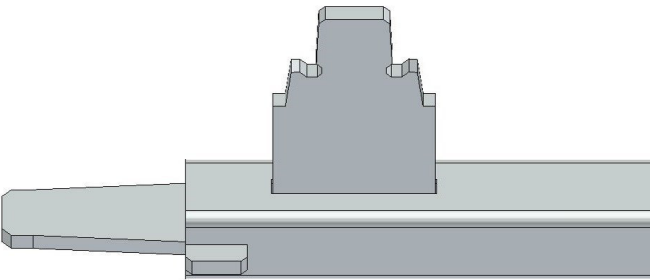

PERI Rental Criteria

MAXIMO



MXP Platform with hatch (115935; 115937)

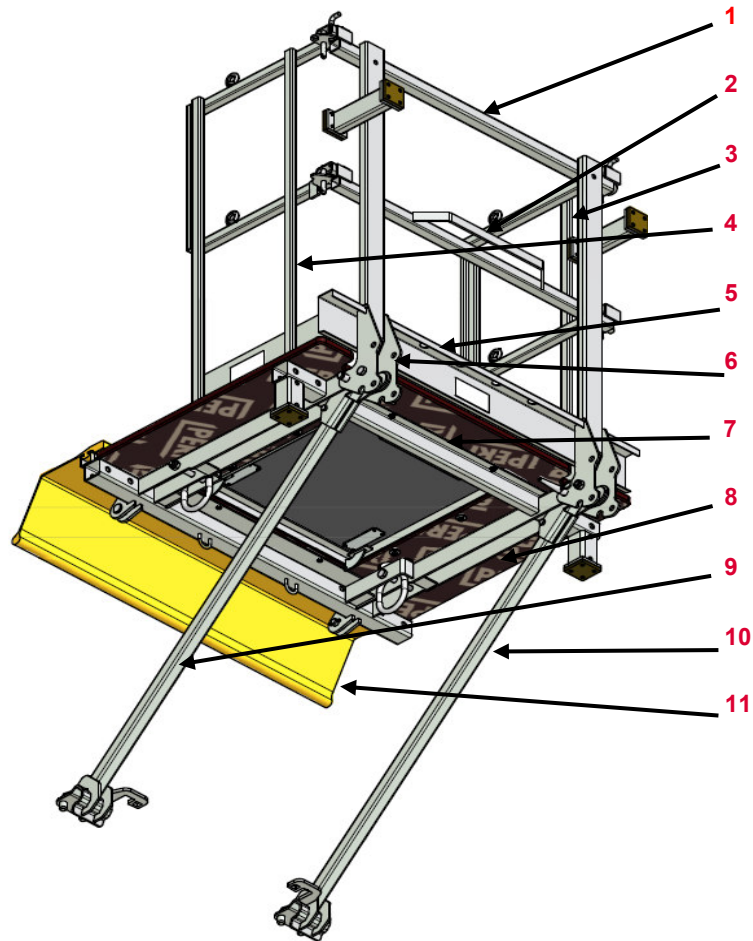













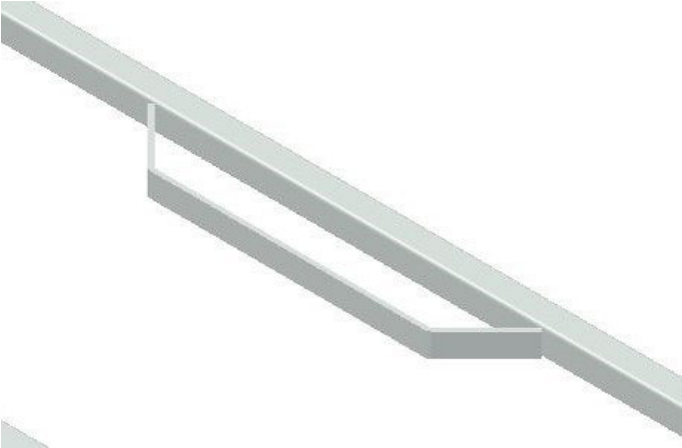

No.	Name	Article number MXP240	Article number MXP120
1	Guard rails	116171	116402
2	Bracket	116349	116349
3	Side guardrail right	115946	115946
4	Side guardrail left	115945	115945
5	Toe board	116169	116399
6	„Vorschweißbaugruppe“	116618	116618
7	Platform bracket	116160	116396
8	Decking MXP with hatch	116080	116105
9	Brace connector left	116012	116012
10	Brace connector right	116015	116015
11	Rubber dust cover	114600	116390

PERI Rental Criteria

MAXIMO



Platform	Description	Instruction	Billing Condition	Type
	26.95 Handrail bent			
	<ul style="list-style-type: none"> ■ ≤ 5 mm ■ Or > 5 mm 	<ul style="list-style-type: none">    MXP 240 (116171) MXP 120 (116402) 	<ul style="list-style-type: none">   088086 088085 	<ul style="list-style-type: none">  
	26.96 Bracket bent			
	<ul style="list-style-type: none"> ■ Without crack in the welding ■ Or with crack in welding 	<ul style="list-style-type: none">   	<ul style="list-style-type: none">  088244  	<ul style="list-style-type: none">  

PERI Rental Criteria

MAXIMO



Platform	Description	Instruction	Billing Condition	Type
	<p>26.97 Toe board bent</p>		088244	
	<p>26.98 Holes in toe board torn out</p>		116399 (120x100) 116169 (240x100)	

PERI Rental Criteria

MAXIMO











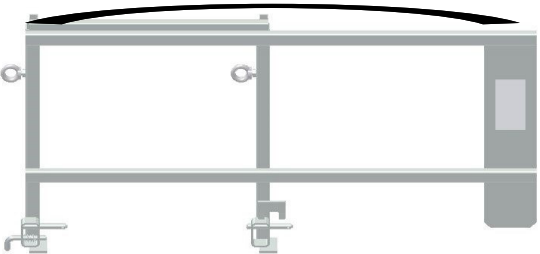



Platform	Description	Instruction	Billing Condition	Type
	<p>26.99 „Vorschweißbaugruppe“ bent</p> <ul style="list-style-type: none"> ■ ≤ 5 mm ■ > 5 mm 	<ul style="list-style-type: none">   116618 	<ul style="list-style-type: none">  088244  	<ul style="list-style-type: none">  

PERI Rental Criteria

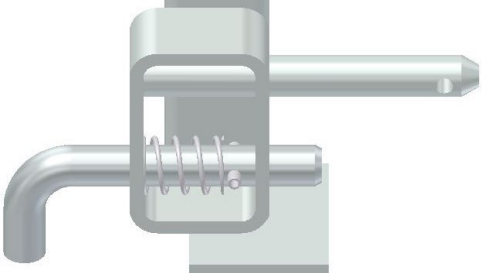
MAXIMO









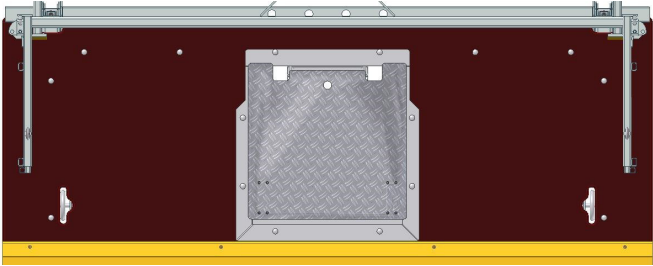

Side guardrail left and right	Description	Instruction	Billing Condition	Type
	<p>26.100 Side guardrail bent</p> <ul style="list-style-type: none"> ■ > 5 mm 			
	<p>26.101 „Bordbrett“ bent or kink</p>	 116050		
	<p>26.102 Bolt defect/ missing</p>	 <p>117956 (bolt) 114288 (spring) 722930 (spring pin)</p>	 088192	

PERI Rental Criteria

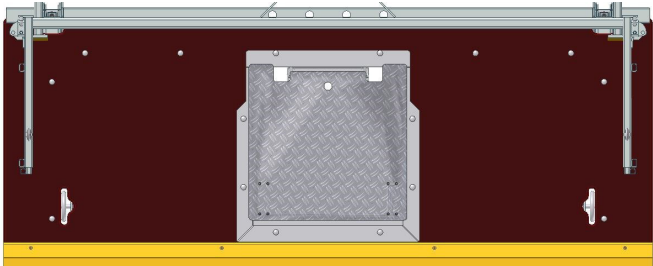
MAXIMO





Deck	Description	Instruction	Billing Condition	Type
	<p>26.103 Deck worn</p>	 <p>116080 (240x100) 116105 (120x100)</p>	 <p>088079 088080</p>	
	<p>26.104 Deck damaged by force</p>	 <p>116080 (240x100) 116105 (120x100)</p>	 <p>088079 088080</p>	

PERI Rental Criteria

MAXIMO



Hatch	Description	Instruction	Billing Condition	Type
	<p>26. 105 Function of the hatch not available because of damages caused by force</p>	 115141	 088099	

PERI Rental Criteria

MAXIMO



Platform	Description	Instruction	Billing Condition	Type
----------	-------------	-------------	-------------------	------

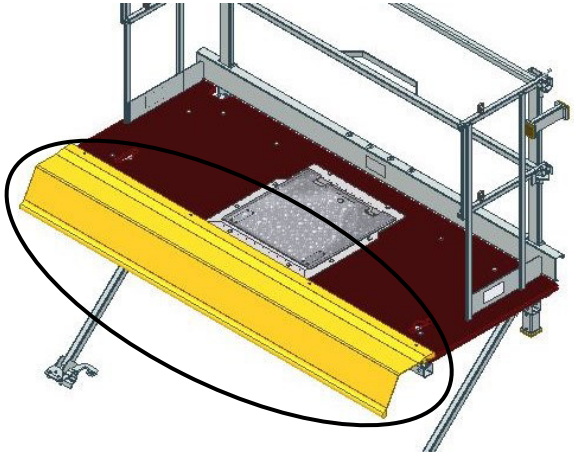

26.106 Rubber dust cover cut , torn



114600 (240x100)
116390 (120x100)



088095
088094



26.107 Brace connector bent

■ > 5 mm



116015 (right)
116012 (left)



088089



PERI Rental Criteria

MAXIMO



MXP Platform without hatch (115936; 115938)

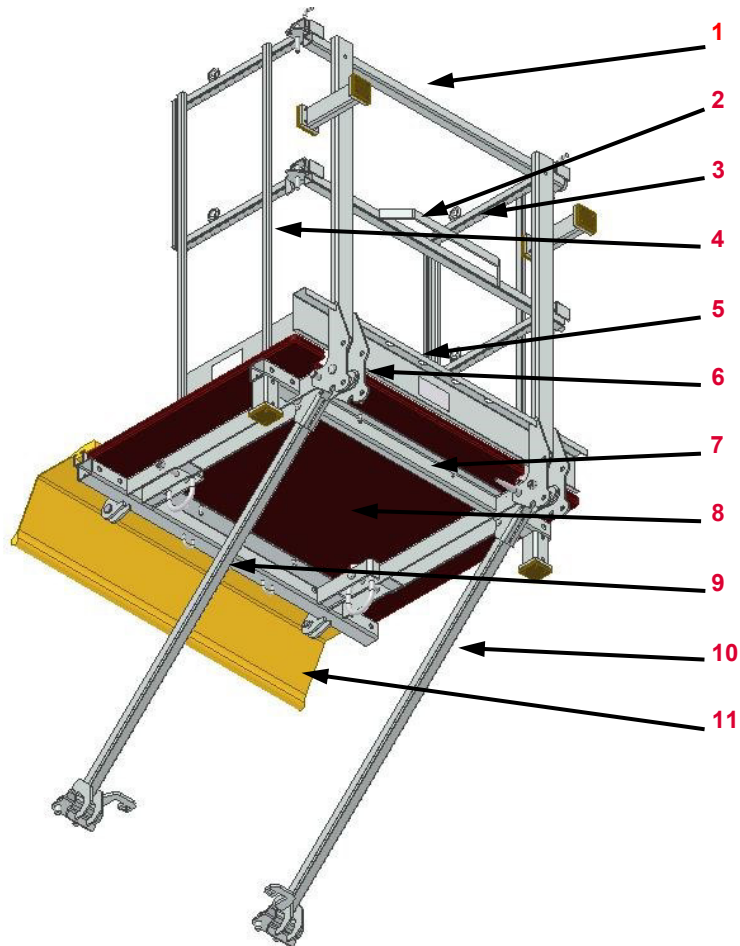













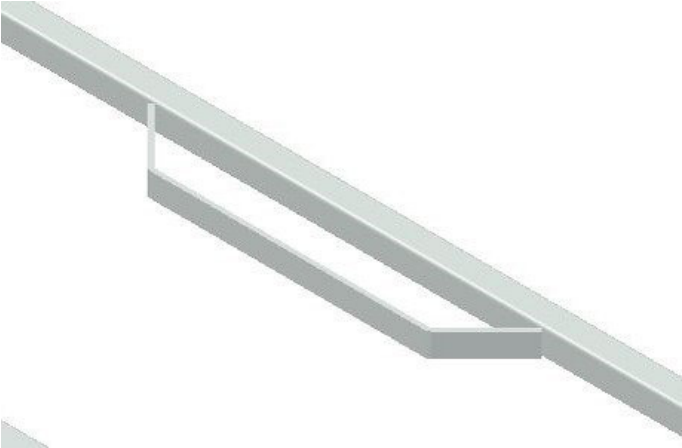

No.	Name	Article number MXP240	Article number MXP120
1	Handrail	116171	116402
2	Bracket	116349	116349
3	Side guardrail right	115946	115946
4	Side guardrail left	115945	115945
5	Toe board	116169	116399
6	„Vorschweißbaugruppe“	116618	116618
7	Platform bracket	116160	116396
8	Deck MXP without hatch	116088	116089
9	Brace connector left	116012	116012
10	Brace connector right	116015	116015
11	Rubber dust cover	114600	116390

PERI Rental Criteria

MAXIMO



Platform	Description	Instruction	Billing Condition	Type
	26.108 Handrail bent			
	<ul style="list-style-type: none"> ■ ≤ 5 mm ■ Or > 5 mm 	<ul style="list-style-type: none">    116171 (MXP 240) 116402 (MXP 120) 	<ul style="list-style-type: none">   088086 088085 	<ul style="list-style-type: none">  
	26.109 Bracket bent			
	<ul style="list-style-type: none"> ■ Without crack in the welding ■ Or with crack in welding 	<ul style="list-style-type: none">   	<ul style="list-style-type: none">  088244  	<ul style="list-style-type: none">  

PERI Rental Criteria

MAXIMO







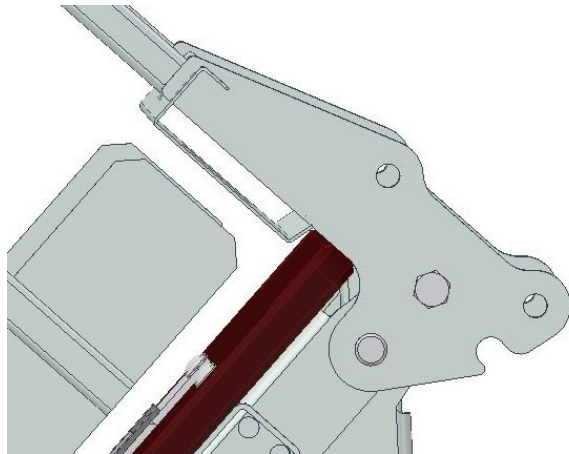

Platform	Description	Instruction	Billing Condition	Type
	<p>26.110 Toe board bent</p>		088244	
	<p>26.111 Holes in toe board torn out</p>		116399 (120x100) 116169 (240x100)	

PERI Rental Criteria

MAXIMO











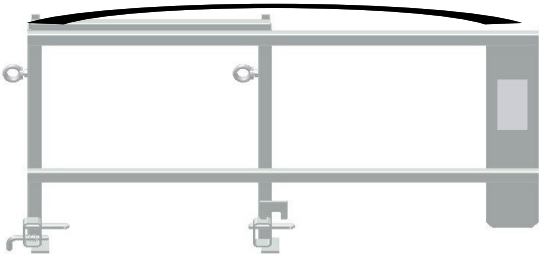



Platform	Description	Instruction	Billing Condition	Type
	<p>26.112 „Vorschweißbaugruppe“ bent</p> <ul style="list-style-type: none"> ■ ≤ 5 mm ■ > 5 mm 	<ul style="list-style-type: none">   116618 	<ul style="list-style-type: none">  088244  	<ul style="list-style-type: none">  

PERI Rental Criteria

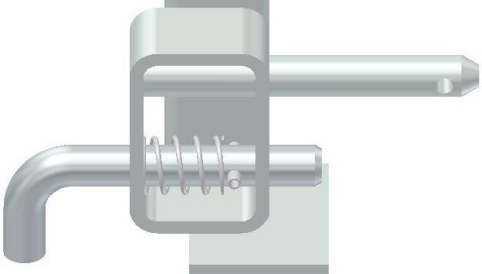
MAXIMO









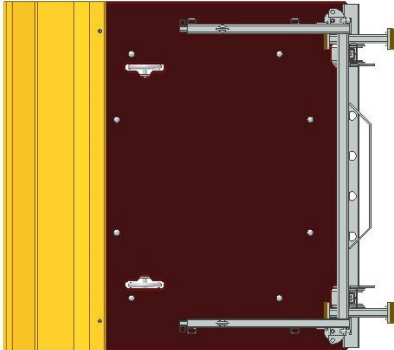

Side guardrail left and right	Description	Instruction	Billing Condition	Type
	<p>26.113 Side guardrail bent</p> <ul style="list-style-type: none"> ■ > 5 mm 			
	<p>26.114 Toe board bent, kink</p>	 116050		
	<p>26.115 Bolt defect, missing</p>	 <ul style="list-style-type: none"> 117956 (bolt) 114288 (spring) 722930 (spring pin) 	 088192	

PERI Rental Criteria

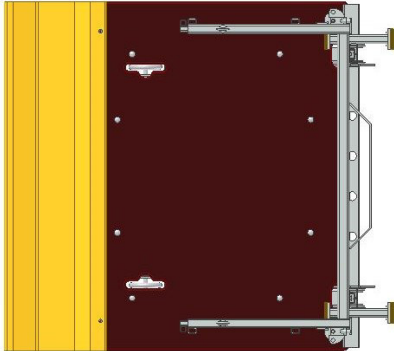
MAXIMO



Deck	Description	Instruction	Billing Condition	Type
	<p>26.116 Deck worn</p>	 <p>116088 (240x100) 116089 (120x100)</p>		
	<p>26.117 Deck damaged by force</p>	 <p>116088 (240x100) 116089 (120x100)</p>	 <p>088082 088078</p>	

PERI Rental Criteria

MAXIMO



Platform	Description	Instruction	Billing Condition	Type
----------	-------------	-------------	-------------------	------

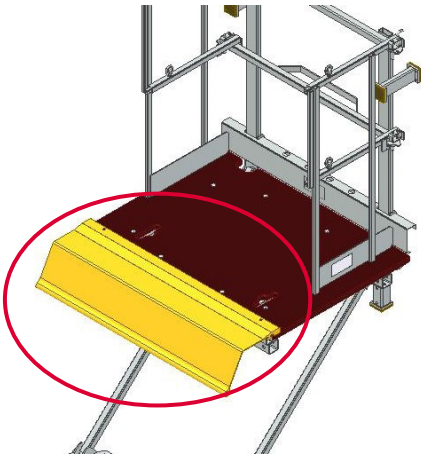

26.118 rubber dust cover in, torn



114600 (240x100)
116390 (120x100)



088095
088094



26.119 Brace connector bent

■ > 5 mm



088089



PERI Rental Criteria

MAXIMO



Platform MXP (115939; 115940)

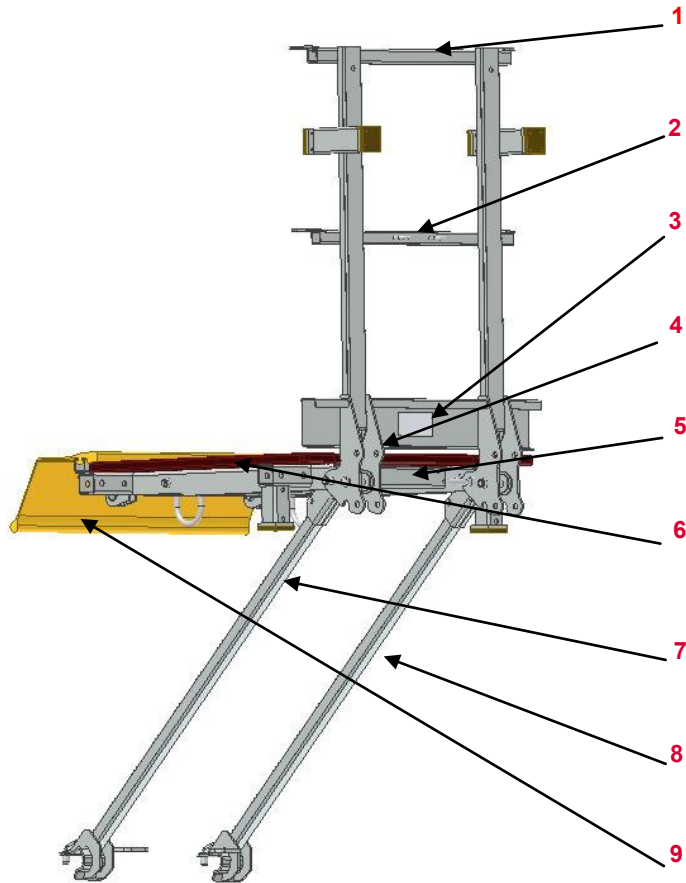









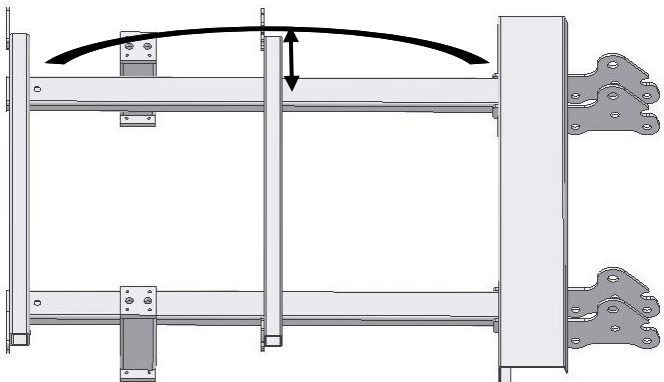



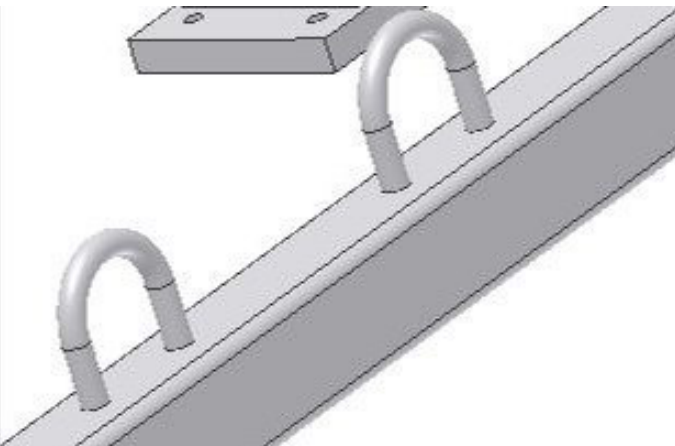

No.	Name	Article number MXP 90	Article number MXP 72
1	Handrail	116244	116558
2	Bracket		
3	Toe board	116242	116556
4	„Vorschweißbaugruppe“	116618	116618
5	Platform bracket	116239	116553
6	Deck MXP	116245	116559
7	Brace connector left	116012	116012
8	Brace connector right	116015	116015
9	Rubber dust cover	116091	116547

PERI Rental Criteria

MAXIMO











Platform	Description	Instruction	Billing Condition	Type
	<p>26.120 Handrail bent</p> <ul style="list-style-type: none"> ■ ≤ 5 mm ■ Or > 5 mm 	<ul style="list-style-type: none">    116244 (MXP 90) 116658 (MXP 72) 	<ul style="list-style-type: none">   088084 088087 	<ul style="list-style-type: none">  
	<p>26.121 Bracket bent</p> <ul style="list-style-type: none"> ■ Without crack in the welding ■ Or with crack in the welding 	<ul style="list-style-type: none">   	<ul style="list-style-type: none">  088244  	<ul style="list-style-type: none">  

PERI Rental Criteria

MAXIMO







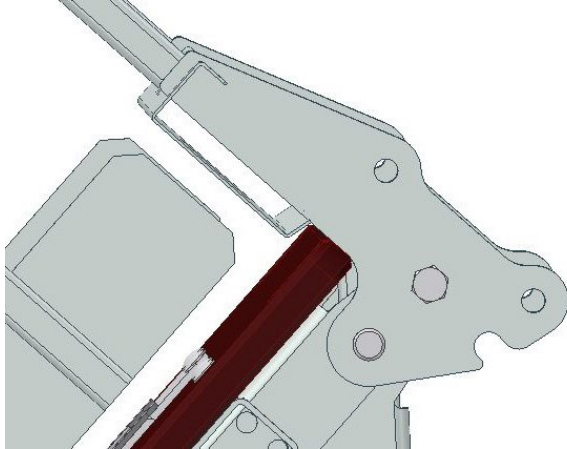

Platform	Description	Instruction	Billing Condition	Type
	<p>26.122 Toe board bent</p>		 088244	
	<p>26.123 Holes in toe board torn out</p>		 116242 (90x100) 116556 (72x100)	

PERI Rental Criteria

MAXIMO





Platform	Description	Instruction	Billing Condition	Type
	<p>26.124 „Vorschweißbaugruppe“ bent</p> <ul style="list-style-type: none"> ■ ≤ 5 mm ■ > 5 mm 	<ul style="list-style-type: none">   116618 	<ul style="list-style-type: none">   	<ul style="list-style-type: none">  

PERI Rental Criteria

MAXIMO



Deck	Description	Instruction	Billing Condition	Type
	26.125 Deck worn	 116245 (90x100) 116559 (72x100)		
	26.126 Deck damaged by force	 116245 (90x100) 116559 (72x100)	 088077 088081	

PERI Rental Criteria

MAXIMO



Platform	Description	Instruction	Billing Condition	Type
----------	-------------	-------------	-------------------	------

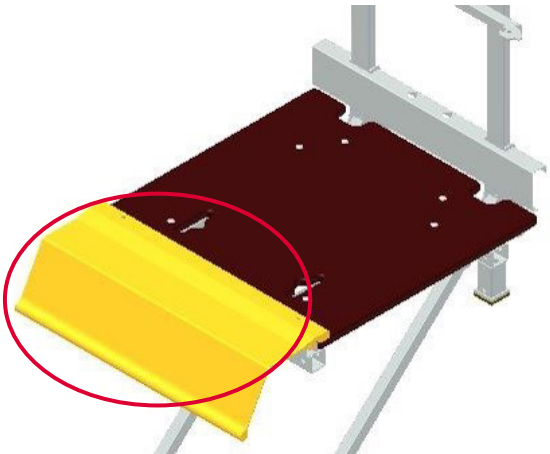

26.127 Rubber dust cover cut in

 116091 (90x100)
116547 (72x100)

 088093
088096



26.128 Brace connector bent

■ > 5 mm

 116012 (left)
116015 (right)

 088089



Scaffold Deck MXK

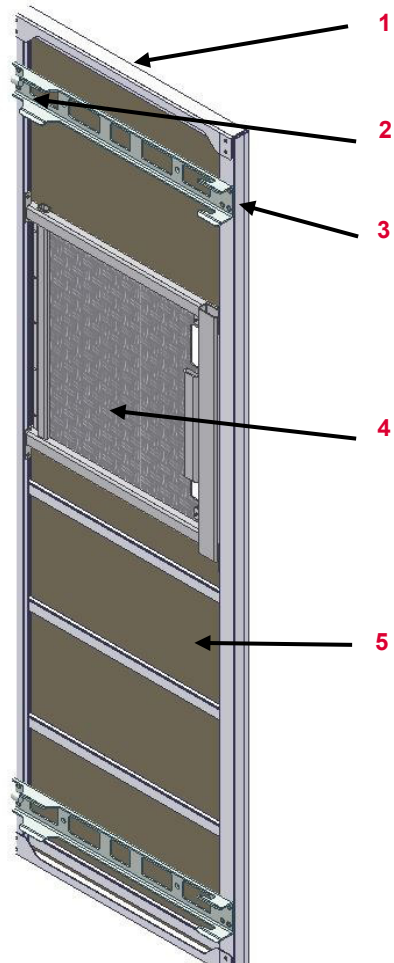











No.	Name	Article number
1	Front profile	127007
2	Guide pin	126751
3	„Belagschiene“	126745
4	Hatch	128720
5	Deck	

Valid for	Article number
Scaffold Deck MXK 240 w. Hatch	128740
Scaffold Deck MXK (Steel) w. Hatch	128812
Scaffold Deck MXK 240	126463
Scaffold Deck MXK 120	125693
Scaffold Deck MXK 90	126927
Scaffold Deck MXK (Steel)	128310
Scaffold Deck MXK (Steel)	128311
Scaffold Deck MXK (Steel)	128312

PERI Rental Criteria

MAXIMO























Scaffold Deck MXK	Description	Instruction	Billing Condition	Type
	26.129 Deck <ul style="list-style-type: none"> ■ Worn 			
	<ul style="list-style-type: none"> ■ Or damaged by force 			
	26.130 Hatch broken			

PERI Rental Criteria

MAXIMO











Scaffold Deck MXK	Description	Instruction	Billing Condition	Type
	26.131 Guide pin bent			
	<ul style="list-style-type: none"> ■ If possible 			
	<ul style="list-style-type: none"> ■ Or if not possible 			
	<ul style="list-style-type: none"> ■ Or crack in material 			
	26.132 „Belagschiene“ bent			
	<ul style="list-style-type: none"> ■ If possible 			
	<ul style="list-style-type: none"> ■ Or if bending not possible 			
	<ul style="list-style-type: none"> ■ Or crack in material 			

PERI Rental Criteria

MAXIMO



Scaffold deck MXK	Description	Instruction	Billing Condition	Type
	<p>26.133 Front profile damaged</p>			
	<p>26.134 Deck bent</p> <p>■ > 5 mm</p>			

PERI Rental Criteria

MAXIMO



Compensation Deck (126541)

No.	Name	Article number
-----	------	----------------

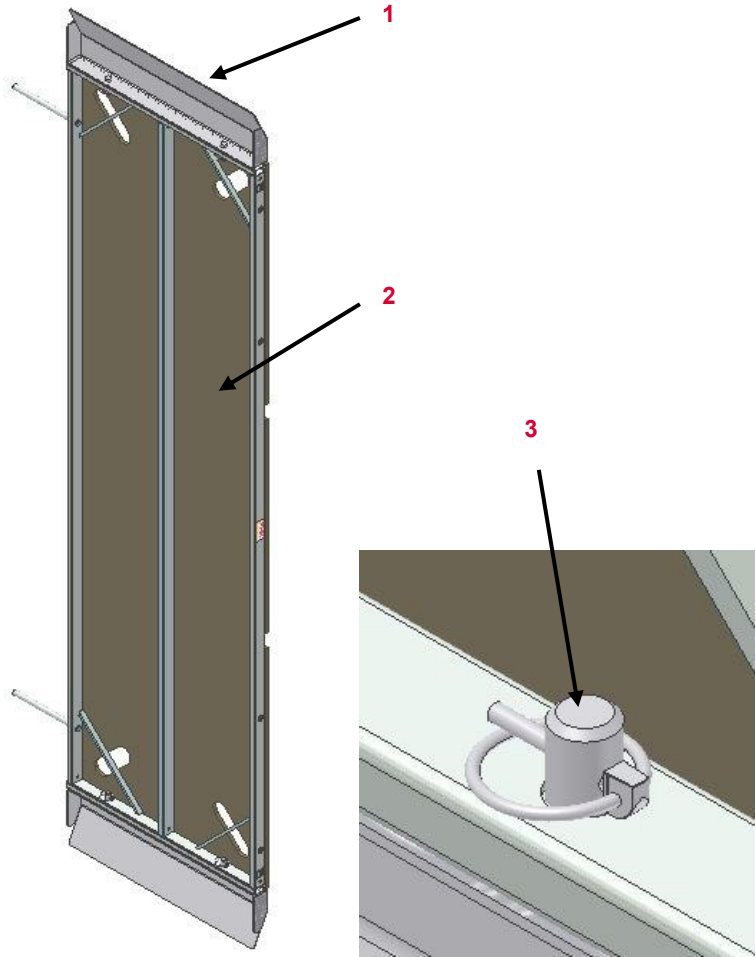









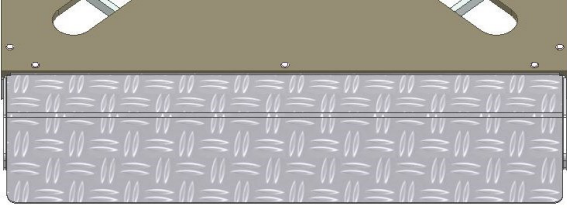





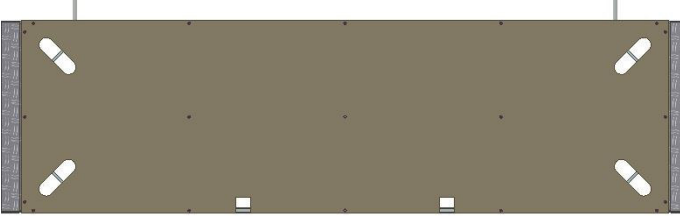

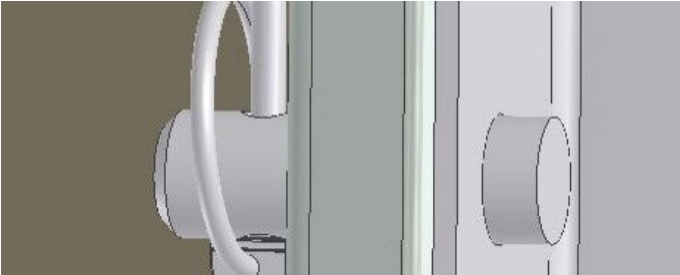

1	Passage	128846
2	Deck	128856
3	Clip pin	127005

PERI Rental Criteria

MAXIMO



Compensation Deck (126541)	Description	Instruction	Billing Condition	Type
	26.135 Passage bent			
	<ul style="list-style-type: none"> <li data-bbox="846 571 1294 606">■ If possible <li data-bbox="846 715 1294 750">■ Or if not possible 	<ul style="list-style-type: none"> <li data-bbox="1294 571 1787 630">  <li data-bbox="1294 715 1787 774">  128846 (Passage) 117285 (Rivet) 	<ul style="list-style-type: none"> <li data-bbox="1787 571 2078 630">  <li data-bbox="1787 715 2078 774">  	<ul style="list-style-type: none"> <li data-bbox="2078 571 2163 630">  <li data-bbox="2078 715 2163 774"> 
	26.136 Deck			
	<ul style="list-style-type: none"> <li data-bbox="846 901 1294 936">■ Worn <li data-bbox="846 1045 1294 1080">■ Or damaged by force 	<ul style="list-style-type: none"> <li data-bbox="1294 901 1787 960">  <li data-bbox="1294 1029 1787 1088">  	<ul style="list-style-type: none"> <li data-bbox="1787 901 2078 960">  <li data-bbox="1787 1029 2078 1088">  	<ul style="list-style-type: none"> <li data-bbox="2078 901 2163 960">  <li data-bbox="2078 1029 2163 1088"> 
	26.137 Clip pin			
	<ul style="list-style-type: none"> <li data-bbox="846 1262 1294 1297">■ Missing <li data-bbox="846 1406 1294 1441">■ Or damaged 	<ul style="list-style-type: none"> <li data-bbox="1294 1230 1787 1318">  127005 (Klappsplint) <li data-bbox="1294 1390 1787 1441">  127005 (Klappsplint) 	<ul style="list-style-type: none"> <li data-bbox="1787 1230 2078 1318">  <li data-bbox="1787 1390 2078 1441">  	<ul style="list-style-type: none"> <li data-bbox="2078 1230 2163 1318">  <li data-bbox="2078 1390 2163 1441"> 

PERI Rental Criteria

MAXIMO



Scaffold Bracket MXK (126356)

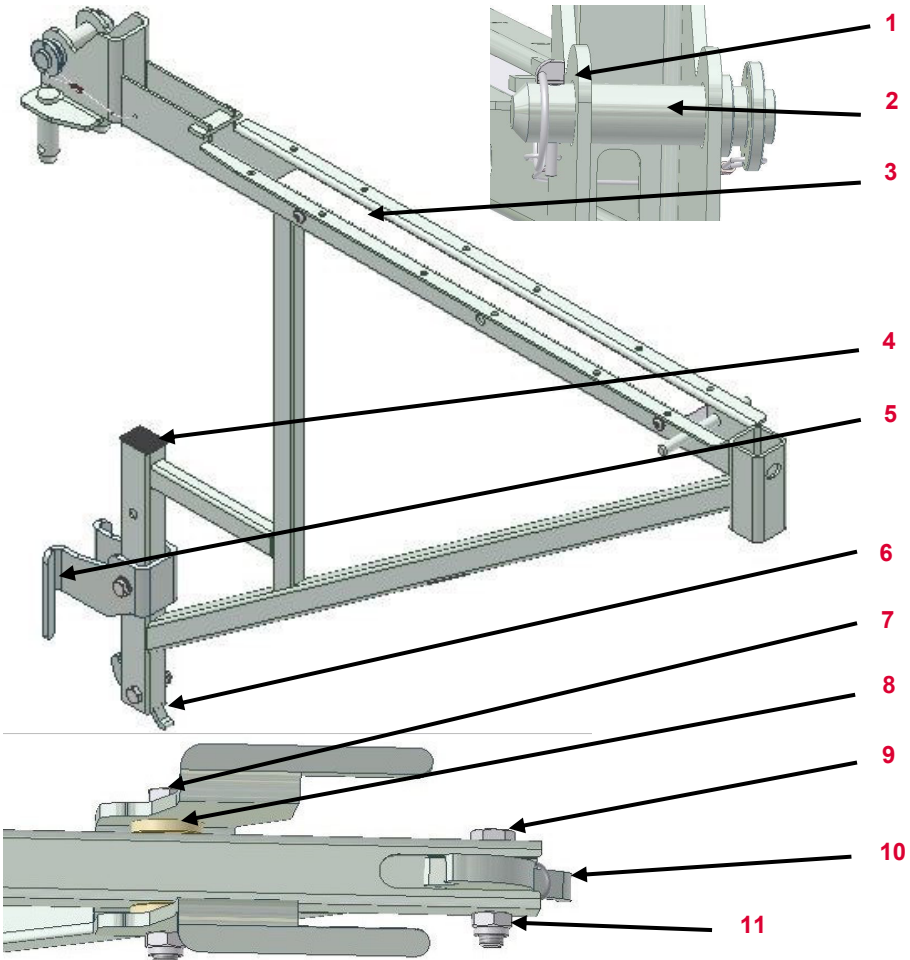













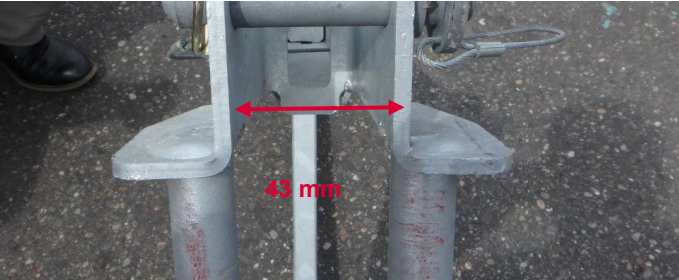

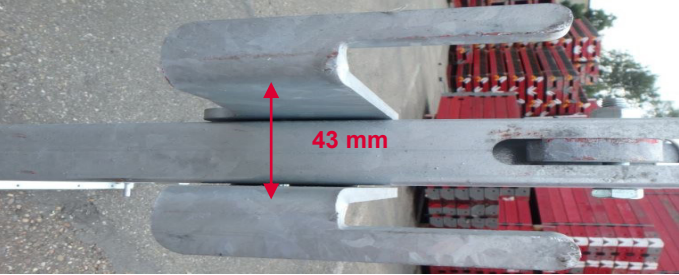

No.	Name	Article number
1	Clip pin	127005
2	Safety bolt	126730
3	Nail board MXK 580	126819
4	Plastic cover	128592
5	Connection head bottom	126728
6	Hook	126732
7	Bolt M 10x70	128356
8	Inserting sleeve	128621
9	Bolt M 10x45	104692
10	Spring	127004
11	Nut M 10	780356

PERI Rental Criteria

MAXIMO



















Scaffold Bracket	Description	Instruction	Billing Condition	Type
	26.138 Nail board worn	 126819		
	26.139 Connection head (top) bent ■ > 43.5 mm			
	■ Or < 42 mm			
	26.140 Connection head (bottom) bent ■ > 43.5 mm			
	■ Or < 42 mm			

PERI Rental Criteria

MAXIMO

















Scaffold bracket	Description	Instruction	Billing Condition	Type
	26.141 Hook broken	 126732		
	26.142 Spring, <ul style="list-style-type: none"> ■ Broken ■ Or worn 	 127004  127004	 	 
	26.143 Spiral rope	 127303		
	<ul style="list-style-type: none"> ■ Missing ■ Or damaged 	 127303		

PERI Rental Criteria

MAXIMO















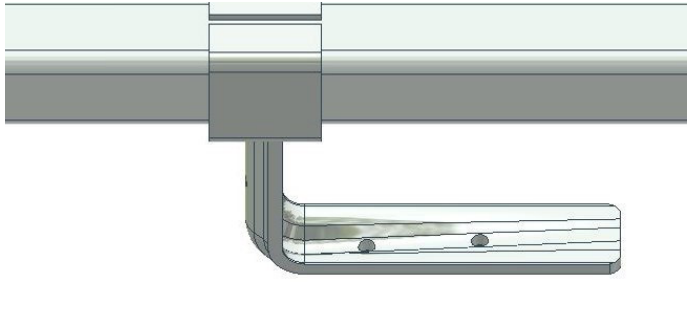

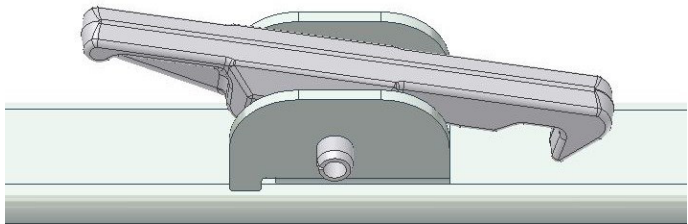

Stopend Rail MXK (126357)	Description	Instruction	Billing Condition	Type
	<p>26.144 Wedge</p> <ul style="list-style-type: none"> ■ Missing ■ Or bent (with crack in material) 	<p>   </p>	<p>   </p>	<p>   </p>
	<p>26.145 "Bordblech" bent</p>	<p></p>	<p></p>	<p></p>
	<p>26.146 Sleeves squeezed bent</p>	<p></p>	<p></p>	<p></p>

PERI Rental Criteria

MAXIMO















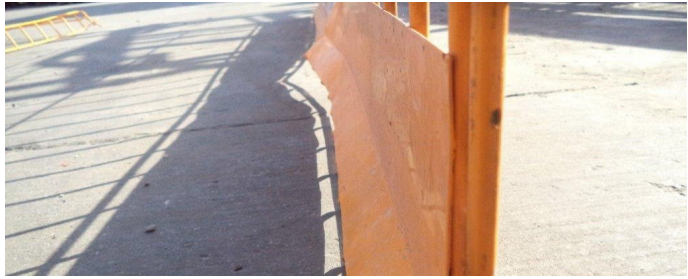

Guardrail post MXK (126360)	Description	Instruction	Billing Condition	Type
	<p>26.147 Bent</p> <ul style="list-style-type: none"> ■ > 10 mm 			
	<p>26.148 Slider</p> <ul style="list-style-type: none"> ■ Missing ■ Oder damaged by force 	 	 	 
	<p>26.149 Safety hook</p> <ul style="list-style-type: none"> ■ Missing ■ Or damaged by force 	 <ul style="list-style-type: none"> 710418 (safety hook) 710420 (spring) 724567 (sleeve)  <ul style="list-style-type: none"> 710418 (safety hook) 710420 (spring) 	 	 

PERI Rental Criteria

MAXIMO



Side Mesh Barrier (126371; 126376;126381)	Description	Instruction	Billing Condition	Type
	<p>26.150 Bar broken</p>		 088072	
	<p>26.151 Mesh</p> <ul style="list-style-type: none"> ■ Bent > 15 mm ■ Or kink 			
	<p>26.152 „Bordbrett“ bent</p> <ul style="list-style-type: none"> ■ If possible ■ Or if not possible 		 088244	
				

PERI Rental Criteria

MAXIMO



Ladder (115915; 114871)	Description	Instruction	Billing Condition	Type
-------------------------	-------------	-------------	-------------------	------



26.153 Tube clip

- Missing
- Or damaged by force



123480 (tube clip)



088007



123480 (tube clip)



088007

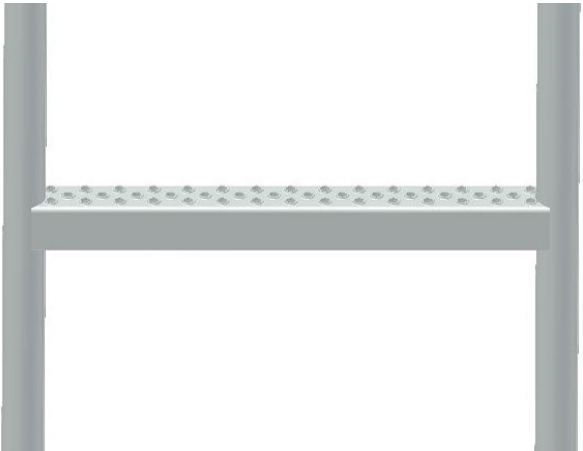

26.154 Footstep bent

- If possible
- Or if not possible
- Or damage in welding



PERI Rental Criteria

MAXIMO



Heated Panel MXH	No.	Name	Article number
------------------	-----	------	----------------

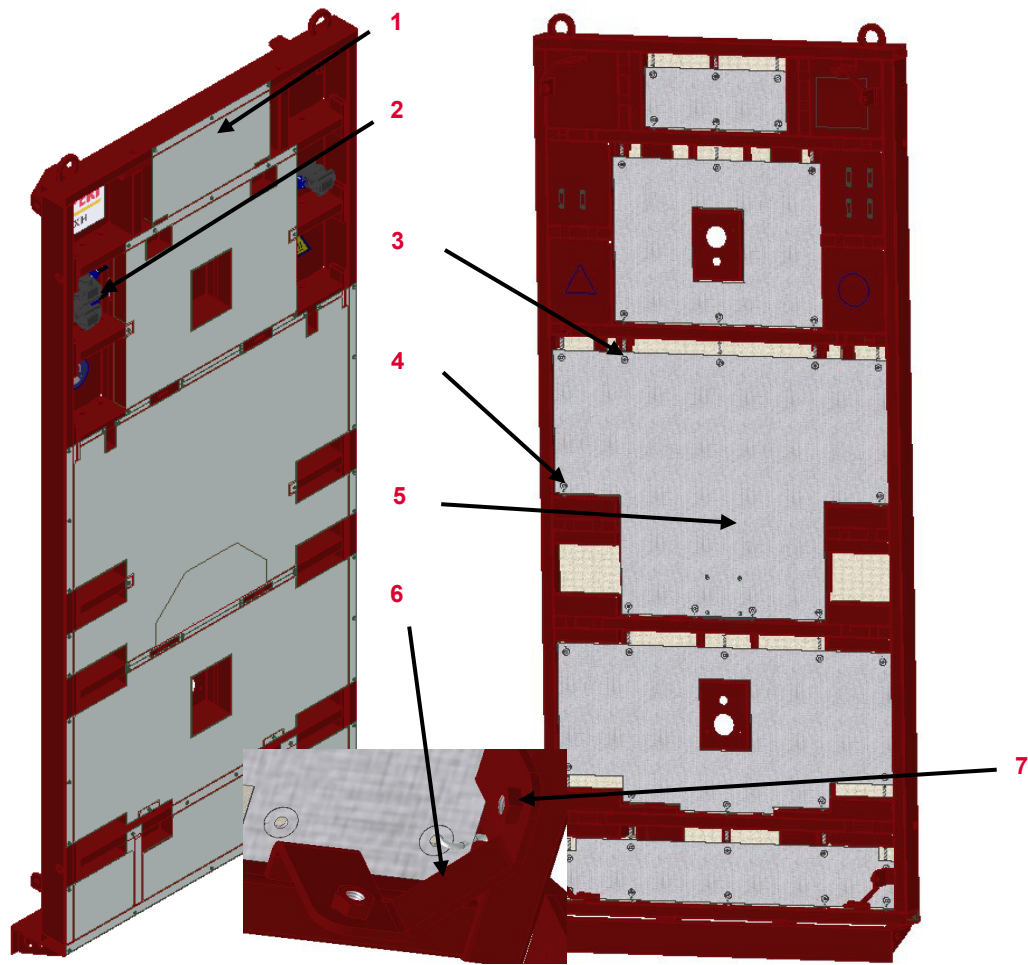













1	Cover plate	
2	Connection	
3	Tension spring	113065
4	S- Hook	113066
5	Heating element	
6	Plate	129161
7	Welding nut	125662

Valid for	Article number
Heated Panel MXH 270x240	129132
Heated Panel MXH 270x120	129133
Extension Heated Panel MXH 120x240	129370
Extension Heated Panel MXH 120x120	129375
Extension Heated Panel MXH 60x240	129134
Extension Heated Panel MXH 60x120	129135

PERI Rental Criteria

MAXIMO















Heated Panel MXH	Description	Instruction	Billing Condition	Type
	<p>26.155 Cover plate bent to the outside</p>	<p> Place a screw (129242)</p>		
	<p>26.156 Cover plate bent to the inside</p>	<p></p>		
	<p>26.157 Dent in cover plate</p> <ul style="list-style-type: none"> ■ No damage of the Isolation heating element 	<p></p>		

PERI Rental Criteria

MAXIMO

















Heated Panel MXH	Description	Instruction	Billing Condition	Type
	<p>26.158 Hexagon socket full of concret</p>			
	<p>26.159 Screw bent broken</p>	 129242		
	<p>26.160 Lever corner Cover plate full of concrete</p>			

PERI Rental Criteria

MAXIMO











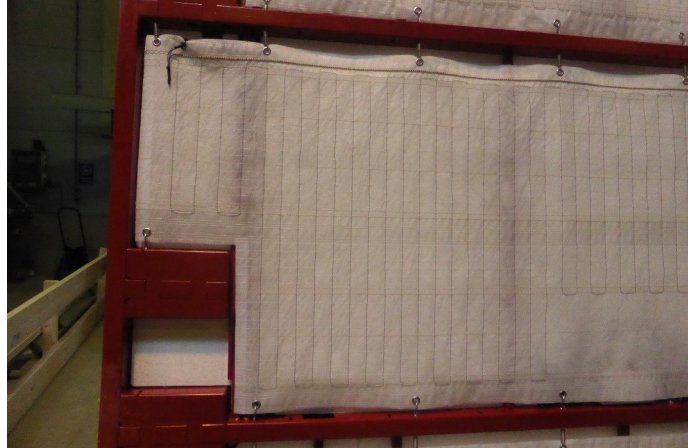



Heated Panel MXH	Description	Instruction	Billing Condition	Type
	<p>26.161 Thread damaged</p> <ul style="list-style-type: none"> ■ If possible ■ Or if not possible 	<ul style="list-style-type: none">  Tap thread  125662 (welding nut) 	<ul style="list-style-type: none">   	<ul style="list-style-type: none">  
	<p>26.162 Connection plate bent</p> <ul style="list-style-type: none"> ■ If possible ■ Or if not possible 	<ul style="list-style-type: none">   126919 (plate) 125662 (welding nut) 	<ul style="list-style-type: none">   	<ul style="list-style-type: none">  

PERI Rental Criteria

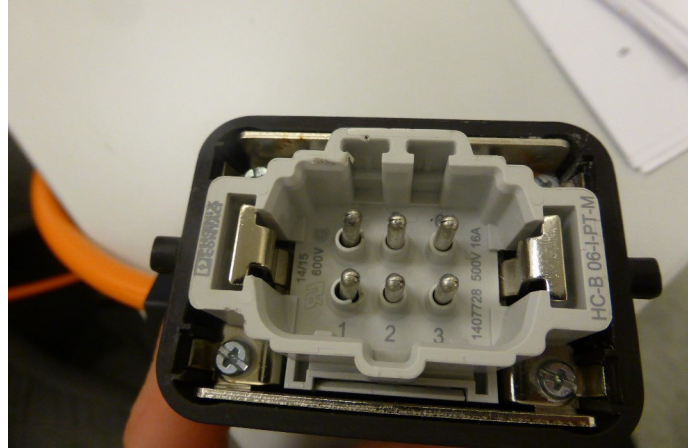
MAXIMO











Heated Panel MXH	Description	Instruction	Billing Condition	Type
	<p>26.163 Heating element broken</p> <ul style="list-style-type: none"> ■ Damaged by force ■ Or damaged without force (worn) 	<p>   Has to be done by an qualified electrician </p> <p>  Has to be done by an qualified electrician </p>	<p>  </p> <p>  </p>	<p>  </p> <p>  </p>
	<p>26.164 Pin at the plug damaged</p>	<p>   Has to be done by an qualified electrician </p>	<p>  </p>	<p>  </p>

PERI Rental Criteria

MAXIMO













Heated Panel MXH	Description	Instruction	Billing Condition	Type
	<p>26.165 Cover of plug broken missing</p>			
	<p>26.166 Connection loose</p>	 Tighten (otherwise risk of moisture)		

PERI Rental Criteria

MAXIMO





















Connector RS MXH (129136)	Description	Instruction	Billing Condition	Type
	<p>26.167 Connection bent</p>			
	<p>26.168. Wing nut</p> <ul style="list-style-type: none"> ■ Not moveable ■ Or wing broken 	<ul style="list-style-type: none">  030190  030190 	<ul style="list-style-type: none">   	<ul style="list-style-type: none">  

PERI Rental Criteria

Glossary Icons



Icon	Significance	Icon	Significance	Icon	Significance
	Not OK– material is scrap		Billing necessary (customer)		Optical damage
	OK– material stays in rental park		No Billing necessary		Functional damage
	Scrap material– it's not permitted to hand out the material because of safety aspects		Shorten the material		Functional damage— it's not permitted to hand out the material
	Repair according to instruction		Mark the material		Static damage— it's not permitted to hand out the material
	Fix material cold– Afterwards check weld seams and bordering components		Replace damaged material		
	Repair after local economic efficiency calculation		Replace missing material		
	Clean the material		Attention voltage		