

PERI Rental Criteria

DUO



Contact

PERI GmbH
Formwork Scaffolding
Engineering
 P.O. Box 1264
 89259 Weissenhorn, Germany
 Phone +49 (0) 7309.950-0
 Fax +49 (0) 7309.951-0
 rental-criteria@peri.de

Content	Page
Formlining	2
Frame	16
Accessories	24
Glossary	43

Changes	Date Initial	Page
New version	08/2015 rf	
Article number added	02/2016 fw	3;24
Several changes	08/2017	
Articles added	10/2018 fw	41-43

PERI Rental Criteria

DUO



DUO Panel	No.	Name	Article number
-----------	-----	------	----------------

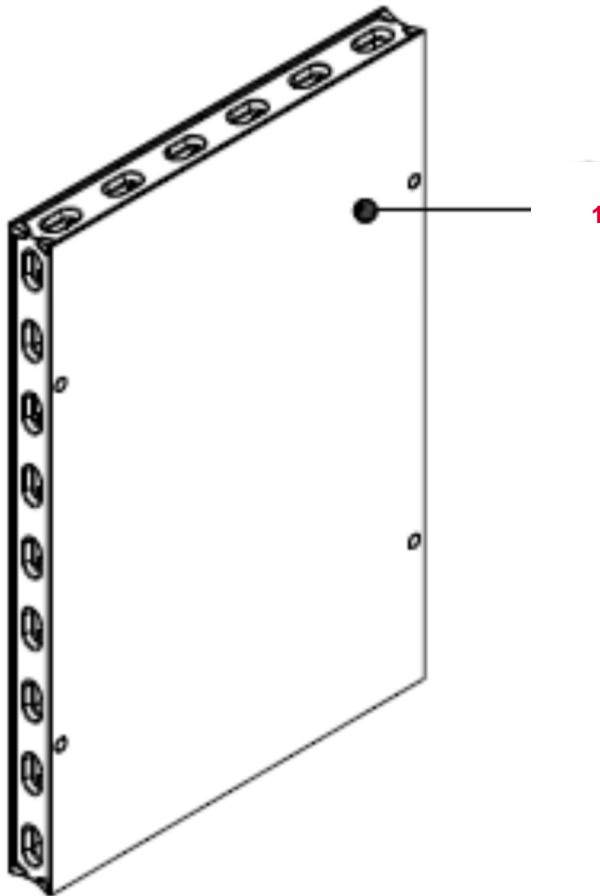

1	Panel	Formlining
	DP 135x90	128228
	DMP 135x75	128229
	DP 135x60	128230
	DMP 135x45	128231
	DP 135x30	128232
	DP 135x15	128233

Valid for	Article number
Panel DP 135 x 90	128280
Multi Panel DMP 135 x 75	128281
Panel DP 135 x 60	128282
Multi Panel DMP 135 x 45	128283
Panel DP 135 x 30	128284
Panel DP 135 x 15	128285

PERI Rental Criteria

DUO



Article	Article number
Panel DP 135 x 90	128280
Multi Panel DMP 135 x 75	128281
Panel DP 135 x 60	128282
Multi Panel DMP 135 x 45	128283
Panel DP 135 x 30	128284
Panel DP 135 x 15	128285
Panel DP 60x90	129837
Multipanel DMP 60 x 75	129838
Panel DP 60 x 60	129839
Multipanel DMP 60 x 45	129840
Panel DP 60 x 30	129841
Panel DP 60 x 15	129842

Article	Article number

PERI Rental Criteria

DUO



Formlining - soiling	Description	Instruction	Billing Condition	Type
----------------------	-------------	-------------	-------------------	------



29.01 Slight soiling



29.02 Strong soiling (no usage of PERI Clean)



088974



PERI Rental Criteria

DUO



Formlining - soiling	Description	Instruction	Billing Condition	Type
----------------------	-------------	-------------	-------------------	------



29.03 Anchor hole soiled with concrete



29.04 Usage of non conform release agents (Diesel, etc.)



Formlining













See table (p. 22)



PERI Rental Criteria

DUO





Formlining - surface damages	Description	Instruction	Billing Condition	Type
	<p>29.05 Damage of the plug in the Multi Panel because of too short distance of the rotor nozzle</p>			
	<p>29.06 Cut in in the formlining because of too short distance of the rotor nozzle</p> <ul style="list-style-type: none"> ■ $D \leq 1 \text{ mm}$ depth ■ Or $D > 1 \text{ mm}$ depth 	<ul style="list-style-type: none">   	<ul style="list-style-type: none">   	<ul style="list-style-type: none">  

PERI Rental Criteria

DUO



Formlining - surface damages

	Description	Instruction	Billing Condition	Type
	<p>29.07 Concrete vibrator damages</p> <ul style="list-style-type: none"> ■ ≤ 1 mm depth ■ Or > 1 mm depth (Welding possible) ■ Or > 1 mm depth (Welding impossible) 	<ul style="list-style-type: none"> ✓ 📊 ⚙️ Formlining 	<ul style="list-style-type: none"> 🚫 089073 📊 See table (p. 22) 	<ul style="list-style-type: none"> 👁️ 👁️ 👁️
	<p>29.08 Damages caused by hammer</p> <ul style="list-style-type: none"> ■ ≤ 1 mm depth ■ Or > 1 mm depth 	<ul style="list-style-type: none"> ✓ ⚙️ Formlining 	<ul style="list-style-type: none"> 🚫 📊 See table (p. 22) 	<ul style="list-style-type: none"> 👁️ 👁️

PERI Rental Criteria

DUO



Formlining - surface damages	Description	Instruction	Billing Condition	Type
------------------------------	-------------	-------------	-------------------	------



29.09 Superficial scratches

- T ≤ 1 mm depth



29.10 Deep scratches

- > 1 mm scratches (welding possible)



089073



- Or > 1 mm scratches (welding impossible)



Formlining



See table (p. 22)



PERI Rental Criteria

DUO



Formlining - surface damages	Description	Instruction	Billing Condition	Type
------------------------------	-------------	-------------	-------------------	------



29.11 Bulged formlining because of hitting from the back side (view from the front)

- $\varnothing \leq 3 \text{ cm}$
- Or $\varnothing > 3 \text{ cm}$



Heat the formlining with the Extruder and hit the dent back



Formlining



See table (p. 22)













Bulged formlining because of hitting from the back side (view from the front side)

PERI Rental Criteria

DUO



Formlining - structural damages	Description	Instruction	Billing Condition	Type
	<p>29.12 Broken formlining</p> <ul style="list-style-type: none"> ■ ≤ 10 cm length 		 089073	
	<p>29.13 Broken formlining</p> <ul style="list-style-type: none"> ■ > 10 cm length and welding possible ■ Or > 10 cm length and welding not possible 	  Formlining	 089073  See table (p. 22)	 

PERI Rental Criteria

DUO

















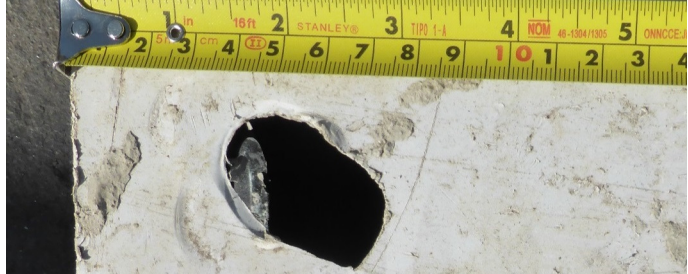

Formlining - edge damages	Description	Instruction	Billing Condition	Type
	<p>29.14 Lightly rubbed formlining</p> <ul style="list-style-type: none"> ■ ≤ 5 mm width 	<p>Deburr the edges with the scratcher</p>		
	<p>29.15 Strongly rubbed formlining</p> <ul style="list-style-type: none"> ■ > 5 mm width and welding possible ■ Or welding not possible 	<p>Formlining</p>	<p>089073</p> <p>See table (p. 22)</p>	

PERI Rental Criteria

DUO















Formlining - structural damages	Description	Instruction	Billing Condition	Type
	<p>29.16 Nail or drilling holes</p> <ul style="list-style-type: none"> ■ ≤ Ø 5 mm 			
	<p>29.17 Small holes</p> <ul style="list-style-type: none"> ■ ≤ 1 cm and welding possible ■ Or welding not possible 	 	 089073  See table (p.22)	 
	<p>29.18 Big holes</p> <ul style="list-style-type: none"> ■ > 1 cm and welding possible ■ Or if not possible 	  Formlining	 089073  See table (p. 22)	 

PERI Rental Criteria

DUO















Formlining - edge damages	Description	Instruction	Billing Condition	Type
	29.19 Notch in formlining edge	<ul style="list-style-type: none"> ■ ≤ 1 cm length and ≤ 1 mm depth 		
	<ul style="list-style-type: none"> ■ Or > 1 cm length and > 1 mm depth 			
	29.21 Formlining edge torn out completely	<ul style="list-style-type: none"> ■ ≤ 5 cm length 		
	<ul style="list-style-type: none"> ■ Or > 5 cm length 			

PERI Rental Criteria

DUO



Formlining - edge damages	Description	Instruction	Billing Condition	Type
	29.22 Rubbed profile corner	<ul style="list-style-type: none"> ■ ≤ 5 mm length  		
	<ul style="list-style-type: none"> ■ Or > 5 mm length 		 089073	
	29.23 Profile corner lifted	<ul style="list-style-type: none"> ■ ≤ 2 cm length  	 089073	
	<ul style="list-style-type: none"> ■ Or > 2 cm length 	 Formlining	 See table (p. 22)	

PERI Rental Criteria

DUO



Formlining - missing components	Description	Instruction	Billing Condition	Type
---------------------------------	-------------	-------------	-------------------	------

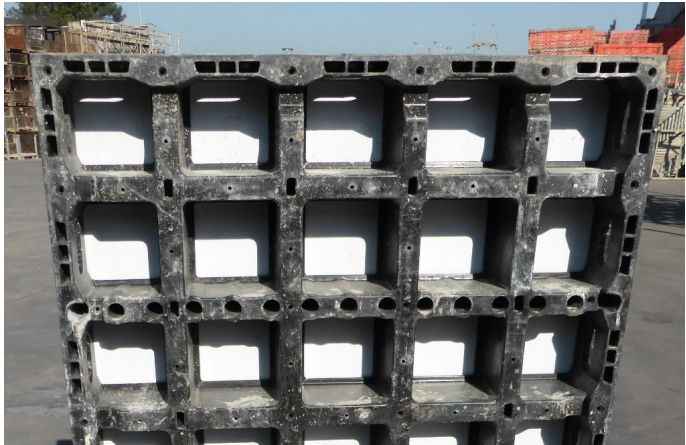

29.24 Missing screws



29.25 Concrete soiling because of missing screws



PERI Rental Criteria

DUO



DUO Panel	No.	Name	Article number
-----------	-----	------	----------------

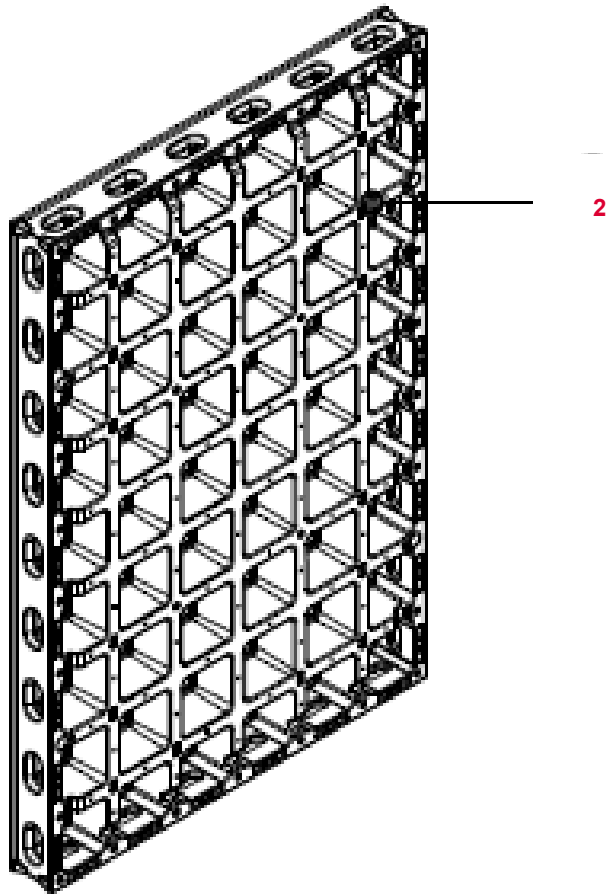



2	Panel	Frame
	DP 135x90	128222
	DMP 135x75	128223
	DP 135x60	128224
	DMP 135x45	128225
	DP 135x30	128226
	DP 135x15	128227

Valid for	Article number
Panel DP 135 x 90	128280
Multi Panel DMP 135 x 75	128281
Panel DP 135 x 60	128282
Multi Panel DMP 135 x 45	128283
Panel DP 135 x 30	128284
Panel DP 135 x 15	128285

PERI Rental Criteria

DUO



Frame - soiling	Description	Instruction	Billing Condition	Type
	29.26 Frame soiled with concrete	 High pressure water cleaning	 089074	
	29.27 Frame bag full of concrete	 High pressure water cleaning or chisel	 089974	
	29.28 Handle full of concrete	 Remove with chisel	 089074	
	29.29 Frame raster full of concrete	 High pressure water cleaning or chisel	 089074	

PERI Rental Criteria

DUO



Formlining - edge damages	Description	Instruction	Billing Condition	Type
---------------------------	-------------	-------------	-------------------	------



29.30 Frame edge damaged

- ≤ 5 mm depth
- Or > 5 mm depth



Frame



See table (p. 22)



29.31 Frame corner damaged

- ≤ 1 cm depth
- Or > 1 cm depth



Frame



See table (p. 22)



PERI Rental Criteria

DUO



Frame - handle	Description	Instruction	Billing Condition	Type
----------------	-------------	-------------	-------------------	------



29.32 Bar broken



Frame



See table (p. 22)



29.33 Bar torn out



Frame















See table (p. 22)



PERI Rental Criteria

DUO



















Frame - cut in	Description	Instruction	Billing Condition	Type
	<p>29.34 Bottom side cut in</p>	 Frame	 See table (p. 22)	
	<p>29.35 Top side cut in (including formlining)</p>	 Frame	 See table (p. 22)	
	<p>29.36 Bottom side torn out</p>	 Frame	 See table (p. 22)	

PERI Rental Criteria

DUO



Frame	Description	Instruction	Billing Condition	Type
	29.37 Nail or drilling holes			
	<ul style="list-style-type: none"> ■ $\leq \text{Ø } 5 \text{ mm}$ ■ Or $> \text{Ø } 5 \text{ mm}$ (outside the marked area, picture below) 	  Frame	  See Table (p. 22)	 
	29.38 Big holes or cracks in the frame			
	<ul style="list-style-type: none"> ■ $\leq \text{Ø } 3 \text{ cm}$ in marked area (same height as handle) ■ Or $> \text{Ø } 3 \text{ cm}$ in marked area 	  Frame	  See table (p. 22)	 
	<ul style="list-style-type: none"> ■ Or $> \text{Ø } 5 \text{ mm}$ outside the marked area 	 Frame	 See table (p. 22)	

PERI Rental Criteria

DUO



Formlining and frame	Description	Instruction	Billing Condition	Type
----------------------	-------------	-------------	-------------------	------



29.39 Anchor hole torn out



29.40 Profile corner torn out



PERI Rental Criteria

DUO



Article	Formlining		Frame	
	Spare part	Service article number	Spare part	Service article number
Panel DP 135 x 90	128228	084407	128222	089066
Multi Panel DMP 135 x 75	128229	084408	128223	089067
Panel DP 135 x 60	128230	084409	128224	089068
Multi Panel DMP 135 x 45	1238231	084410	128225	089069
Panel DP 135 x 30	128232	084411	128226	089070
Panel DP 135 x 15	128233	084412	128227	089071

PERI Rental Criteria

DUO



Wall thickness compensation

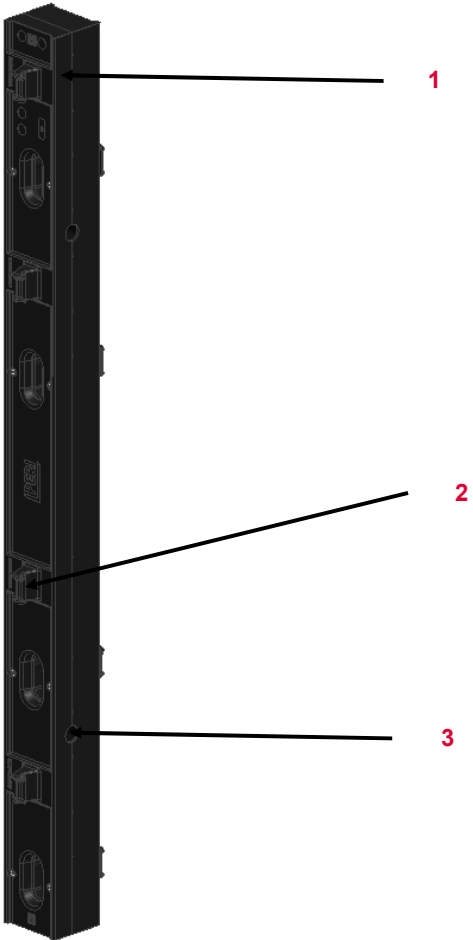













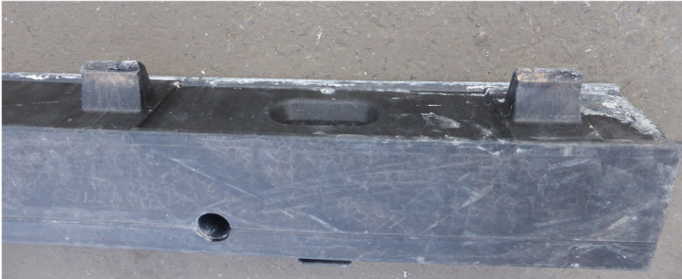

No.	Name	Article number
1	Compensation shell DWC	
2	Tooth	
3	Compensation insert	

Valid for	Article number
Wall thickness compensation DWC 135x10	128292
Wall thickness compensation DWC 135x9	128291
Wall thickness compensation DWC 135x8	128290
Wall thickness compensation DWC 135x7	128289
Wall thickness compensation DWC 135x6	128288
Wall thickness compensation DWC 135x5	128287
Wall thickness compensation DWC 60x5	129879
Wall thickness compensation DWC 60x6	129880
Wall thickness compensation DWC 60x7	129881
Wall thickness compensation DWC 60x8	129883
Wall thickness compensation DWC 60x9	129883
Wall thickness compensation DWC 60x10	129884

PERI Rental Criteria

DUO



Wall thickness compensation	Description	Instruction	Billing Condition	Type
	29.41 Anchor hole device torn out	 		
	29.42 Teeth torn out	 		
	29.43 Holes	 		

PERI Rental Criteria

DUO



Connector DUO (128247)	Description	Instruction	Billing Condition	Type
------------------------	-------------	-------------	-------------------	------



29.44 Parts broken off



29.69 Soiled with concrete



PERI Rental Criteria

DUO



Tube holder (128293)	Description	Instruction	Billing Condition	Type
----------------------	-------------	-------------	-------------------	------



29.45 Tube holder torn out



29.70 Soiled with concrete



PERI Rental Criteria

DUO



Brace connector (128294)	Description	Instruction	Billing Condition	Type
--------------------------	-------------	-------------	-------------------	------



29.46 Eye broken



29.47 Turning knob broken



128254



089072



PERI Rental Criteria

DUO



Crane eye (128296)	Description	Instruction	Billing Condition	Type
--------------------	-------------	-------------	-------------------	------

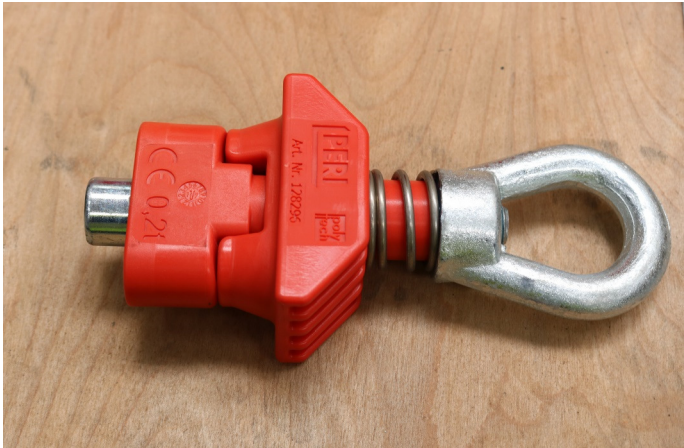









29.48 Parts torn out or function is not available (picture shows no damage)

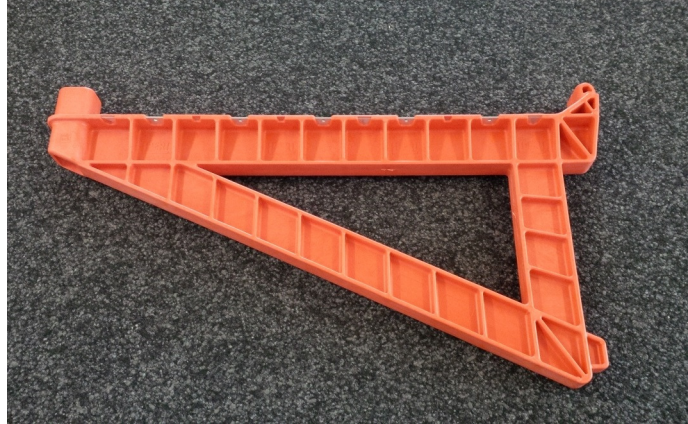

PERI Rental Criteria

DUO



Scaffold bracket (128257)	Description	Instruction	Billing Condition	Type
	<p>29.49 1st. Test version made of plastic (material has to be sort out! Replaced by 2nd version)</p>			
	<p>29.50 2nd. Version plastic bracket reinforced with steel</p>			

PERI Rental Criteria

DUO



Scaffold bracket (128257)	Description	Instruction	Billing Condition	Type
---------------------------	-------------	-------------	-------------------	------



29.71 Broken



29.72 Soiled with concrete



PERI Rental Criteria

DUO



Compensation waler (128255)	Description	Instruction	Billing Condition	Type
-----------------------------	-------------	-------------	-------------------	------



29.51 Broken in the middle



29.73 Broken in the end parts



PERI Rental Criteria

DUO



Extension Support (129809; 128710; 129811)	Description	Instruction	Billing Condition	Type
--	-------------	-------------	-------------------	------



29.52 Parts torn out

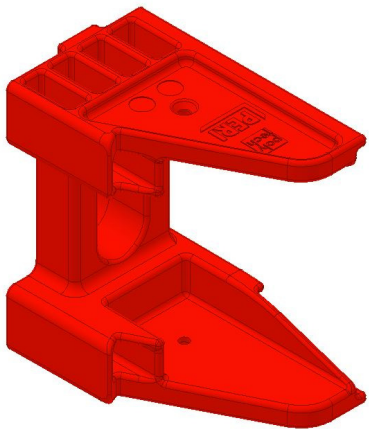

29.53 Crack in Material















- > 3 mm deep



PERI Rental Criteria

DUO



Coupling tie DUO (128256)	Description	Instruction	Billing Condition	Type
	<p>29.54 Thread</p> <ul style="list-style-type: none"> ■ Worn ■ Or damaged by force 	<div style="display: flex; flex-direction: column; gap: 10px;"> <div style="display: flex; gap: 5px;">   </div> <div style="display: flex; gap: 5px;">   </div> </div>	<div style="display: flex; flex-direction: column; gap: 10px;">   </div>	<div style="display: flex; flex-direction: column; gap: 10px;">   </div>
	<p>29.55 Parts torn out</p>	<div style="display: flex; gap: 5px;">   </div>		

PERI Rental Criteria

DUO



Corner DC (128286; 129864)	Description	Instruction	Billing Condition	Type
----------------------------	-------------	-------------	-------------------	------



29.56 Parts torn out





29.57 Teeth torn out



PERI Rental Criteria

DUO



Fix Head DFH (128298; 129862)	Description	Instruction	Billing Condition	Type
	<p>29.58 Scratches Cracks</p> <ul style="list-style-type: none"> ■ ≤ 5 mm deep ■ Or > 5 mm deep 	<ul style="list-style-type: none"> ✓ 🗑️ 🚫 	<ul style="list-style-type: none"> 🚫 📦 	<ul style="list-style-type: none"> 👁️ 📦 kg
	<p>29.59 Parts torn out Holes in article</p>	<ul style="list-style-type: none"> 🗑️ 🚫 	<ul style="list-style-type: none"> 📦 	<ul style="list-style-type: none"> 📦 kg

PERI Rental Criteria

DUO



Fix Head DFH (128298; 129862)	Description	Instruction	Billing Condition	Type
-------------------------------	-------------	-------------	-------------------	------

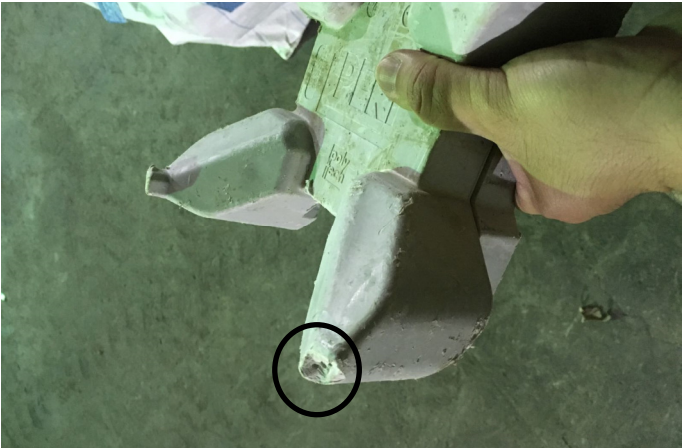

29.60 Nose broken off

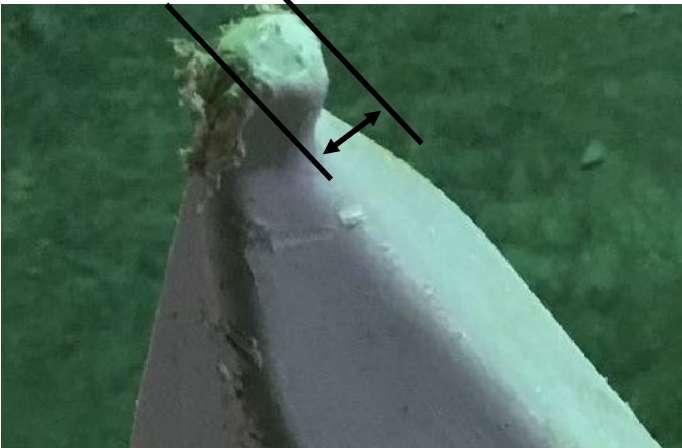

29.61 Nose worn

■ Distance < 5 mm



PERI Rental Criteria

DUO



Guardrail Post Holder (128297)	Description	Instruction	Billing Condition	Type
--------------------------------	-------------	-------------	-------------------	------



29.63 Parts broken off



29.64 Cracks in material

- > 3 mm deep



PERI Rental Criteria

DUO



Wall holder DUO 82 (128263)	Description	Instruction	Billing Condition	Type
-----------------------------	-------------	-------------	-------------------	------

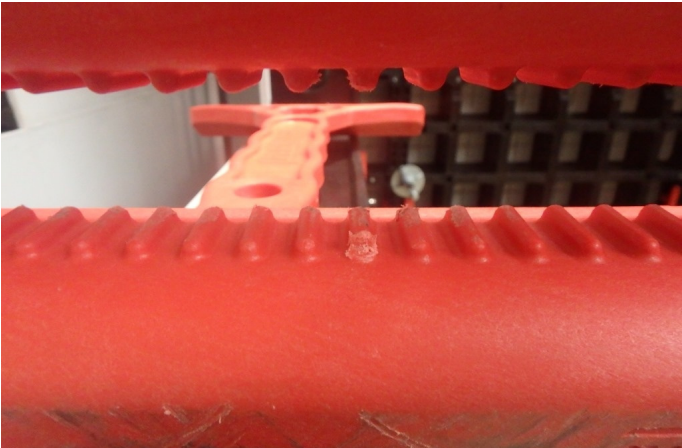

29.65 Teeth

- Worn (tie rod slip through)
- Or broken off

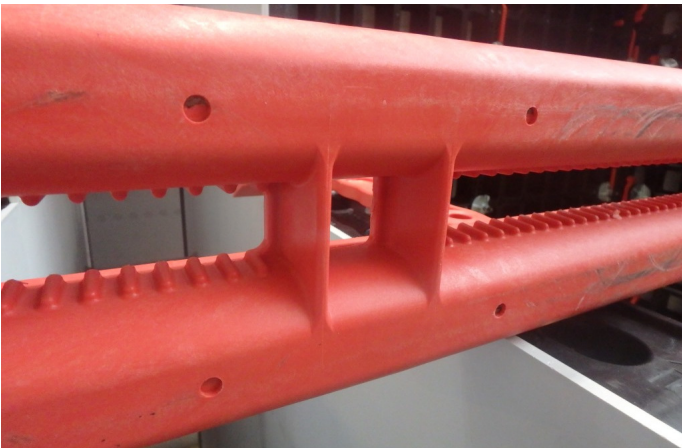

29.66 Parts broken off



PERI Rental Criteria

DUO



Frame Holder DUO (129976)	Description	Instruction	Billing Condition	Type
---------------------------	-------------	-------------	-------------------	------

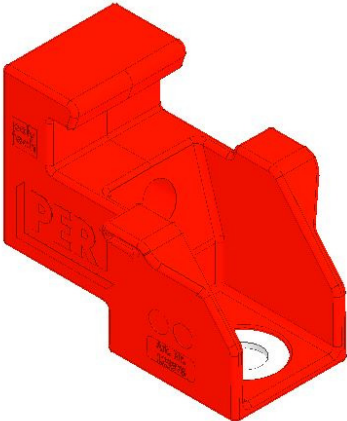

29.67 Parts broken off

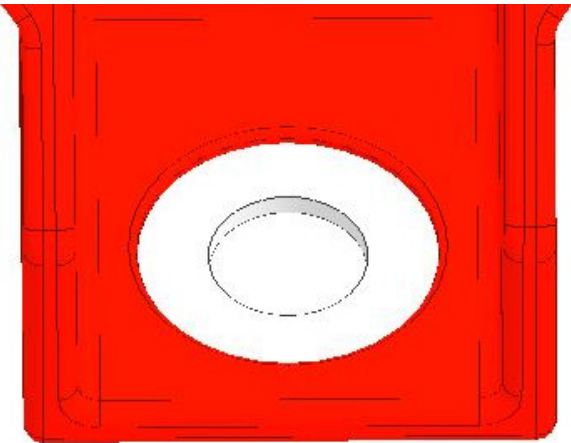

29.68 Insert of the frame holder cracked | broken



PERI Rental Criteria

DUO



Girder Adapter (131061)	Description	Instruction	Billing Condition	Type
-------------------------	-------------	-------------	-------------------	------



29.74 Teeth torn out



29.75 Profile parts torn out

- ≤ 300 mm length



- Or > 300 mm



PERI Rental Criteria

DUO



Shoring Adapter DUO (131139)	Description	Instruction	Billing Condition	Type
------------------------------	-------------	-------------	-------------------	------

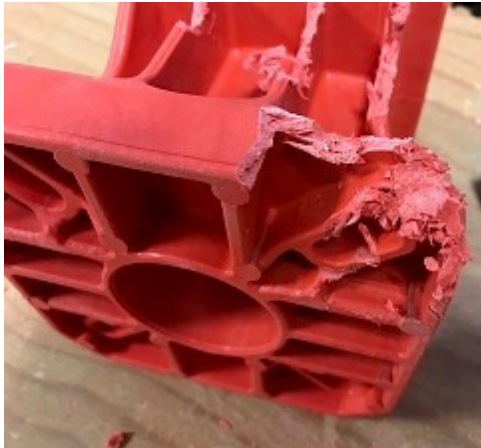

29.76 Parts torn out



29.77 Internal seat damaged

- Function given



- Or not given



PERI Rental Criteria

DUO



Front Post Holder (131242)	Description	Instruction	Billing Condition	Type
----------------------------	-------------	-------------	-------------------	------



29.78 Cracks in anchor area



















29.79 Post seat damaged



PERI Rental Criteria

Glossary Icons



Icon	Significance	Icon	Significance	Icon	Significance
	Not Ok– material is scrap		Billing necessary (customer)		Optical damage
	OK– material stays in rental park		No Billing necessary		Functional damage
	Scrap material– it's not permitted to hand out the material because of safety aspects		Shorten material		Functional damage— it's not permitted to hand out the material
	Repair according to instruction		Mark material		Static damage— it's not permitted to hand out the material
	Fix material cold– Afterwards check weld seams and bordering components		Replace damaged material		
	Repair after local economic efficiency calculation		Replace missing material		
	Clean material				