

PERI Rental Criteria

SKYDECK

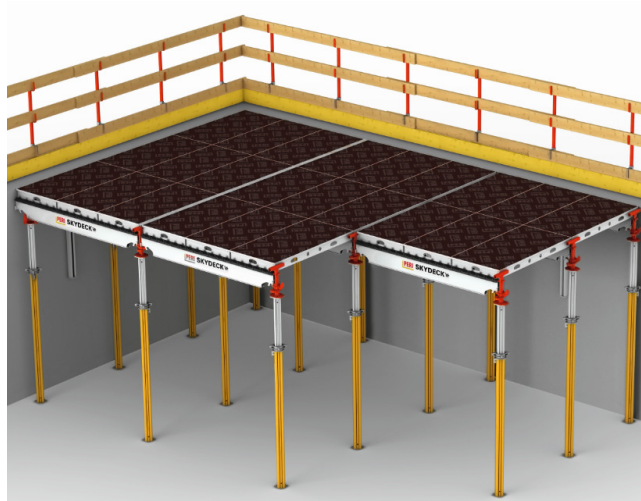

Contact

PERI GmbH
Formwork Scaffolding
Engineering
P.O. Box 1264
89259 Weissenhorn, Germany
Phone +49 (0) 7309.950-0
Fax +49 (0) 7309.951-0
rental-criteria@peri.de

Content	Page	Changes made	Date Initial	Page
Frame SDP	2	New version	09/2015 cg	
Main beam SLT	8	Stripping Cart added	06/2016 fw	35
Cover strip SAL	14	Broken welding at Prophead added 21.49	05/2017 fw	19
Prophead SSK I Combi- Head SCK I Drophead SFK	16	SKY Anchor added	01/2018 fw	32
Edge beam SRT-2	25	Hatch at Heads widened	01/2018 fw	18
Triangular frame SDR	27			
Wall holder SWH-2	30			
SKY Anchor	31			
Platform	36			

PERI Rental Criteria

SKYDECK



SKYDECK Panels	No.	Name	Article number
----------------	-----	------	----------------

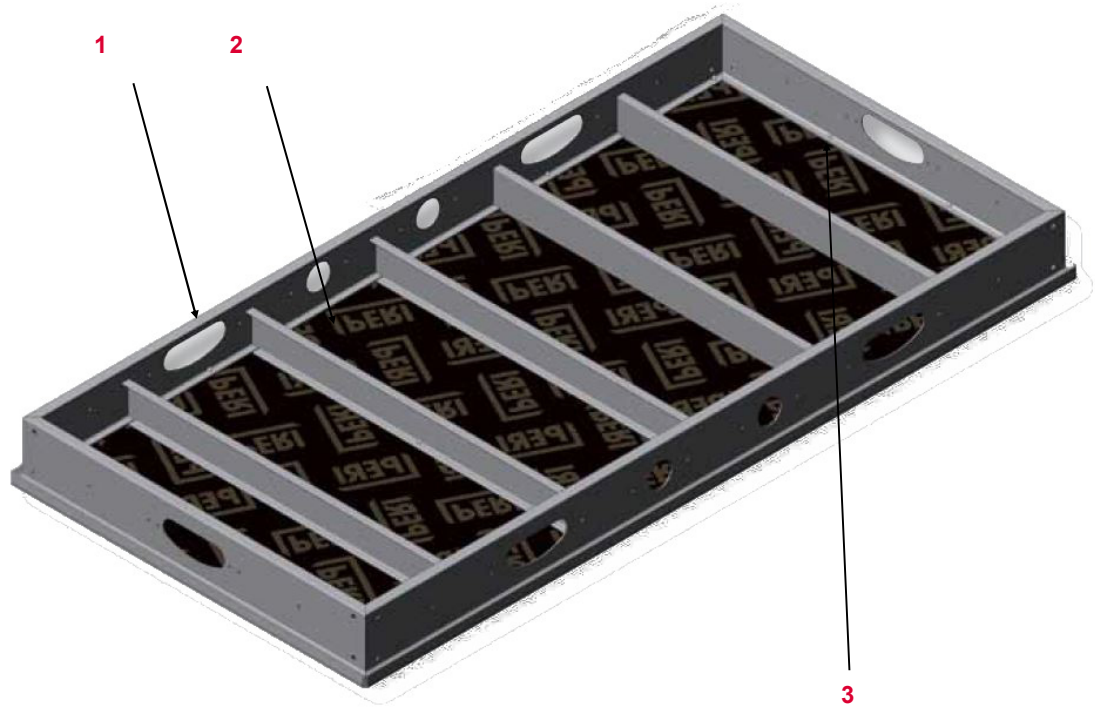

1	Frame	
2	Finply	
3	Rivet	780305









Valid for:

Panel SDP 150 x 75	061000
Panel SDP 150 x 50	061011
Panel SDP 150 x 37,5	061020
Panel SDP 75 x 75	061010
Panel SDP 75 x 50	061013
Panel SDP 75 x 37,5	061030

PERI Rental Criteria

SKYDECK











Frame damages SDP	Description	Instruction	Billing Condition	Type	
	21.01 Kink in profile				
	21.02 Dent in finply support			088027	

PERI Rental Criteria

SKYDECK



Frame damages SDP	Description	Instruction	Billing Condition	Type
	<p>21.03 Dent in bottom side of the frame</p> <p>■ ≥ 3 mm</p>		 088027	
	<p>21.04 Crack in the outside welding</p>		 088028	

PERI Rental Criteria

SKYDECK



Frame damages SDP	Description	Instruction	Billing Condition	Type
-------------------	-------------	-------------	-------------------	------



21.05 Welding broken at the finply support



088028



21.06 Welding broken under the finply support



PERI Rental Criteria

SKYDECK



Frame damages SDP	Description	Instruction	Billing Condition	Type
-------------------	-------------	-------------	-------------------	------



21.07 Parts torn out at the handle



21.08 Crack in the handle











088028



PERI Rental Criteria

SKYDECK



Frame damages SDP	Description	Instruction	Billing Condition	Type
	<p>21.09 Crack in the welding of the brace</p> <ul style="list-style-type: none"> Without damages at the brace 			
	<p>21.10 Crack in the welding of the brace</p> <ul style="list-style-type: none"> With deformations at the brace 		 <p>088028</p>	

PERI Rental Criteria

SKYDECK



Main Beam SLT	No.	Name	Article number
---------------	-----	------	----------------

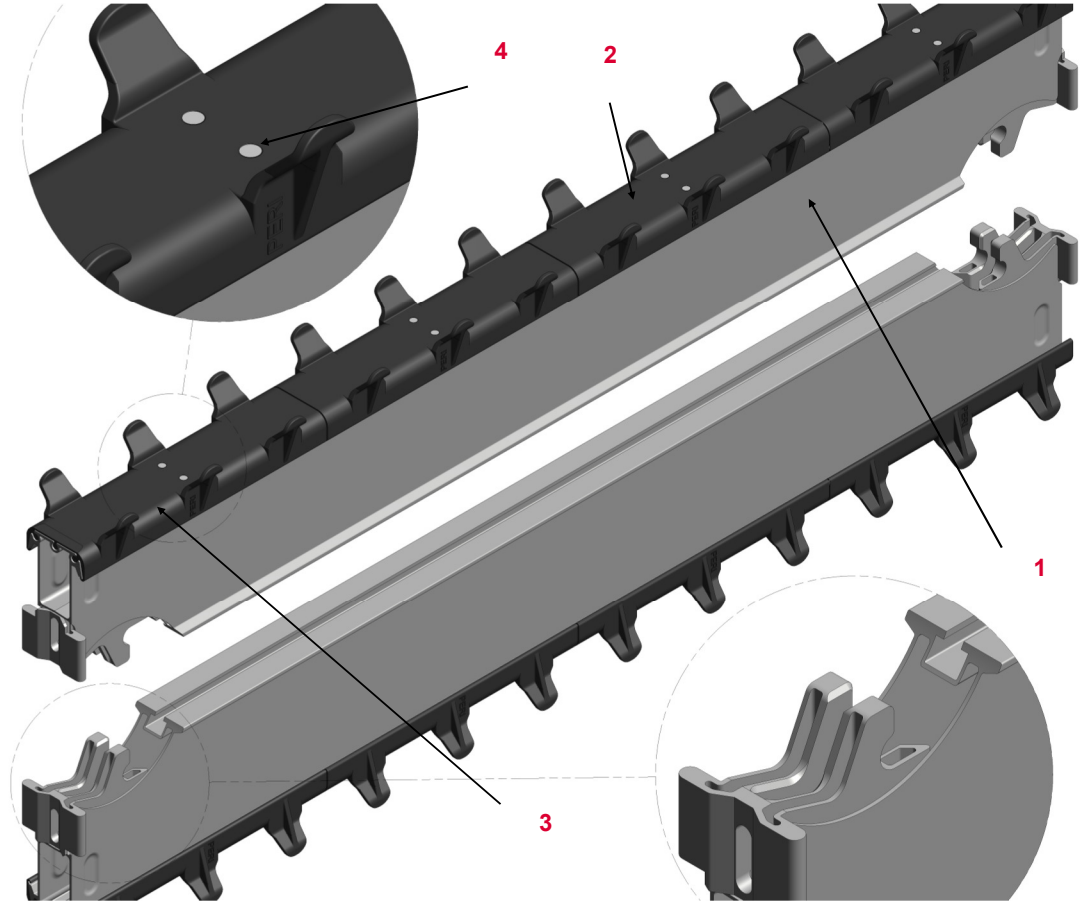







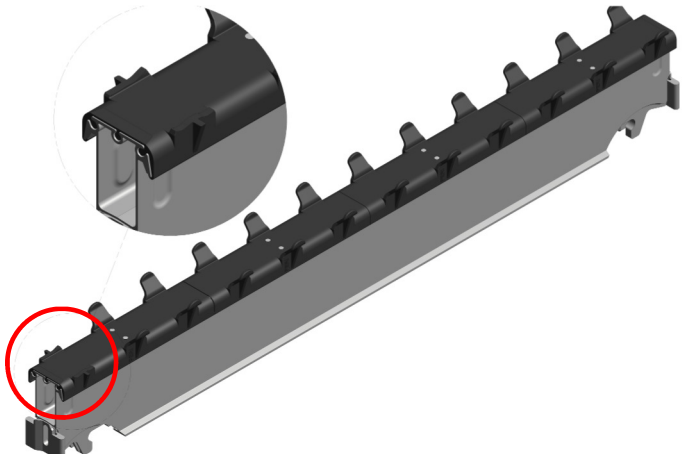

1	Beam	
2	Plastic center piece	061400
3	Plastic end piece	061410
4	Rivet	780012

Valid for	
Main Beam SLT 375	061160
Main Beam SLT 225	061100
Main Beam SLT 150	061110

PERI Rental Criteria

SKYDECK



















Deformations	Description	Instruction	Billing Condition	Type
	<p>21.11 Plastic piece damaged</p>		 088319	
	<p>21.12 Connection of main beam bent</p> <ul style="list-style-type: none"> ■ > 5 mm 		 088333	

PERI Rental Criteria

SKYDECK











Welding	Description	Instruction	Billing Condition	Type
	<p>21.13 Crack in the welding of the Connection</p> <ul style="list-style-type: none"> ■ Crack through inner and outer layer of the beam 			
	<p>21.14 Crack in the welding of the Connection</p> <ul style="list-style-type: none"> ■ Crack only in the outer layer 		 <p>088331</p>	

Welding I Deformation	Description	Instruction	Billing Condition	Type
	<p>21.15 Crack in the welding of the Connection</p> <ul style="list-style-type: none"> ■ Crack in the statical affected welding 			
	<p>21.16 Main beam bent</p> <ul style="list-style-type: none"> ■ ≥ 3 mm 			

PERI Rental Criteria

SKYDECK













Deformation	Description	Instruction	Billing Condition	Type
	<p>21.17 Hole in the inside of the beam</p> <ul style="list-style-type: none"> ■ No deformation of the profile 			
	<p>21.18 Profile bent</p>	 		

PERI Rental Criteria

SKYDECK



Cracks I Holes	Description	Instruction	Billing Condition	Type
	<p>21.19 Cracks in the inside of the profile</p> <ul style="list-style-type: none"> ■ ≥ 15 mm length 	 		
	<p>21.20 Hole in the profile</p> <ul style="list-style-type: none"> ■ $> \varnothing 5$ mm 	 		

PERI Rental Criteria

SKYDECK



Protection strip SAL	No.	Name	Article number
----------------------	-----	------	----------------

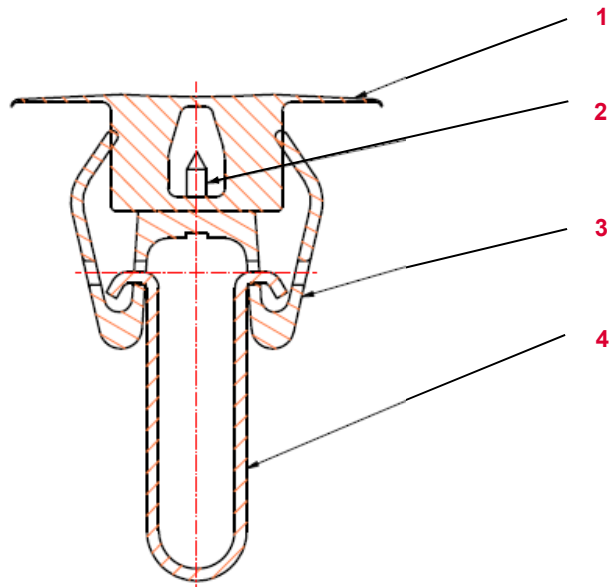
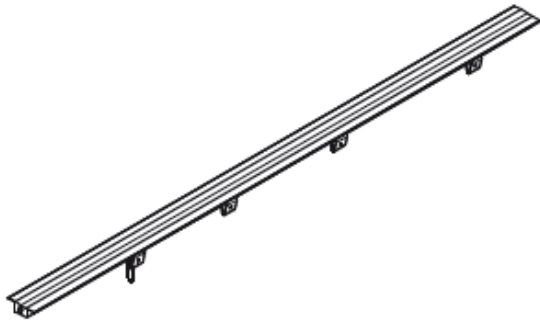

1	Profile	785196
2	Screw	108780
3	ZYTEL-W-springSAL	110736
4	Handle RD 2,5 SAL	110735













Valid for:

Protection strip SAL 150	061026
Protection strip SAL 75	061027
Protection strip SAL 50	061024
Protection strip SAL 37,5	061038

PERI Rental Criteria

SKYDECK



Torn I Missing component	Description	Instruction	Billing Condition	Type
	<p>21.21 Parts torn out</p> <ul style="list-style-type: none"> ■ > 10 cm 	 		
	<p>21.22 Missing components</p> <ul style="list-style-type: none"> ■ Spring missing ■ Or handle (photo) 			
				

PERI Rental Criteria

SKYDECK



Prophead SSK I Combi- Head SCK I Drophead SFK	No.	Name	Article number
---	-----	------	----------------

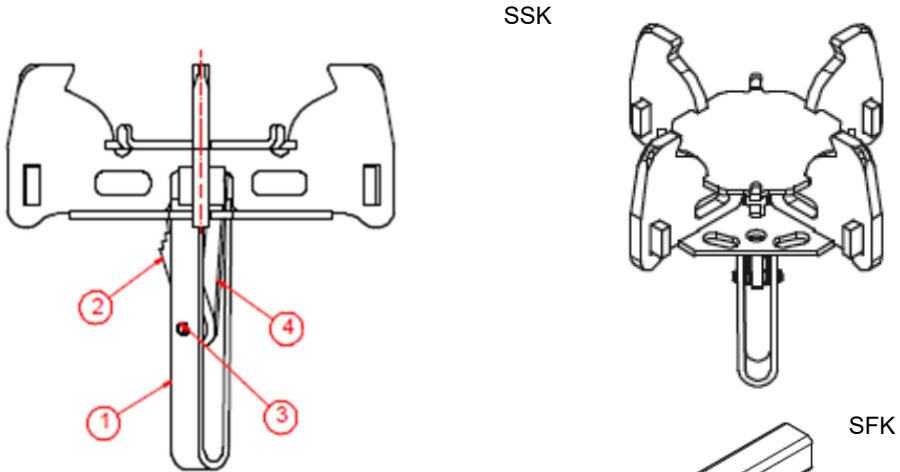

SSK

1	Hatchet	721325
2	Safety hook	721321
3	Sleeve	721332
4	Spring	721330

Valid for:

Prophead SSK	061200
Combi- Head SCK	061180
Drophead SFK	061210

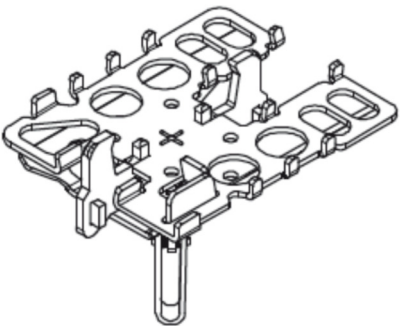

SCK

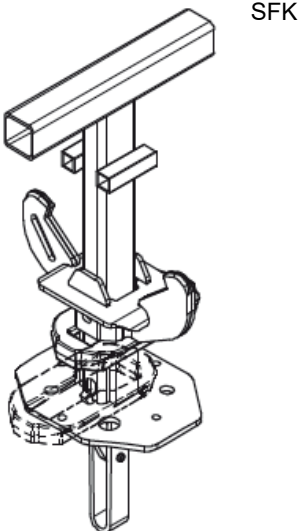

SFK

PERI Rental Criteria

SKYDECK



Deformations	Description	Instruction	Billing Condition	Type
--------------	-------------	-------------	-------------------	------



21.23 Pieces torn out



21.24 Spring damaged



PERI Rental Criteria

SKYDECK













Deformations	Description	Instruction	Billing Condition	Type
	<p>21.49 Hatch widened</p> <ul style="list-style-type: none"> ■ ≤ 30 mm ■ Or > 30 mm 	<ul style="list-style-type: none"> ■ ≤ 30 mm: ■ Or > 30 mm: 	<ul style="list-style-type: none"> ■ ≤ 30 mm: ■ Or > 30 mm: 	<ul style="list-style-type: none"> ■ ≤ 30 mm: ■ Or > 30 mm:

PERI Rental Criteria

SKYDECK



Prophead	Description	Instruction	Billing Condition	Type
	<p>21.25 Heavily bent Cut off</p>	 		
	<p>21.26 Hatchet heavily bent</p>	 		

PERI Rental Criteria

SKYDECK



Prophead	Description	Instruction	Billing Condition	Type
----------	-------------	-------------	-------------------	------

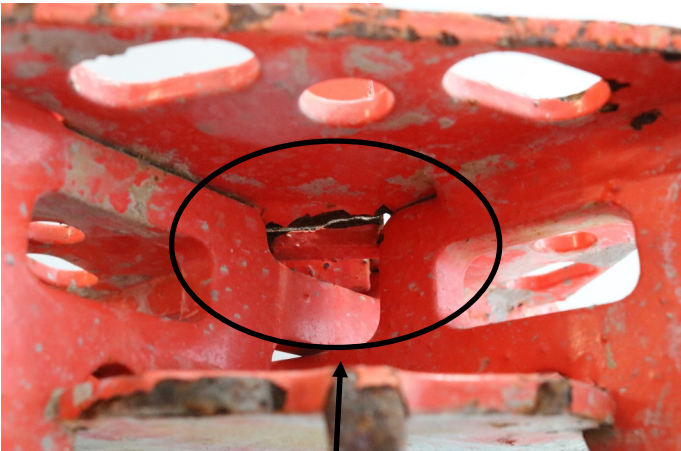

21.50 Broken welding underneath the hatchet

- With deformation of the hatchet
- Or without deformation of the hatchet

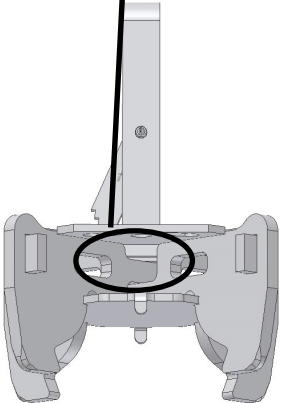

PERI Rental Criteria

SKYDECK



Combi- Head SSK	Description	Instruction	Billing Condition	Type
-----------------	-------------	-------------	-------------------	------



21.27 Pieces heavily bent



21.28 Combi- Head heavily bent | torn out



PERI Rental Criteria

SKYDECK



Combi- Head SCK	Description	Instruction	Billing Condition	Type
-----------------	-------------	-------------	-------------------	------



21.29 Hatchet heavily bent | broken



21.30 Spring damaged



721330











088304



PERI Rental Criteria

SKYDECK







Drophead SFK	Description	Instruction	Billing Condition	Type
	<p>21.31 Heavily bent</p>			
	<p>21.32 Hatchet bent missing</p>			

PERI Rental Criteria

SKYDECK



Drophead SFK	Description	Instruction	Billing Condition	Type
	21.33 Spring missing	 721330	 088304	

PERI Rental Criteria

SKYDECK



Edge Beam SRT-2

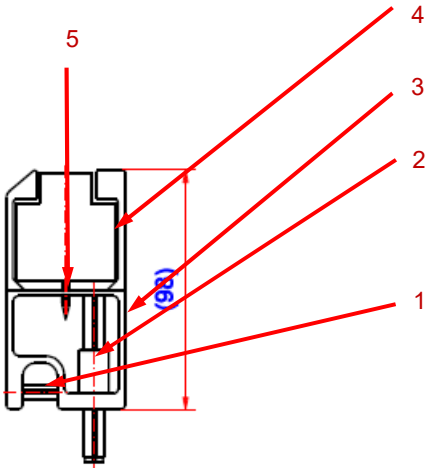
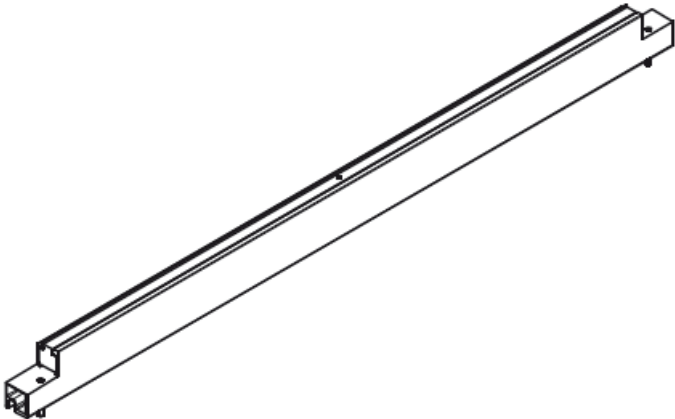

No.	Name	Article number
1	Sleeve 6X20	780801
2	Sleeve 8X70	770013
3	Tube	770009
4	Wood board	
5	Nail RNC-SB 28/60 NK	727285

Valid for:

Edge Beam SRT-2 150	061045
Edge Beam SRT-2 75	061046

PERI Rental Criteria

SKYDECK



Deformation I Worn	Description	Instruction	Billing Condition	Type
--------------------	-------------	-------------	-------------------	------



21.34 Cracks in the profile | Parts torn out



21.35 Wood board worn | Inserting of nails not possible

 780130 (SRT 75)
 780129 (SRT 150)



PERI Rental Criteria

SKYDECK



Triangular frame SDR

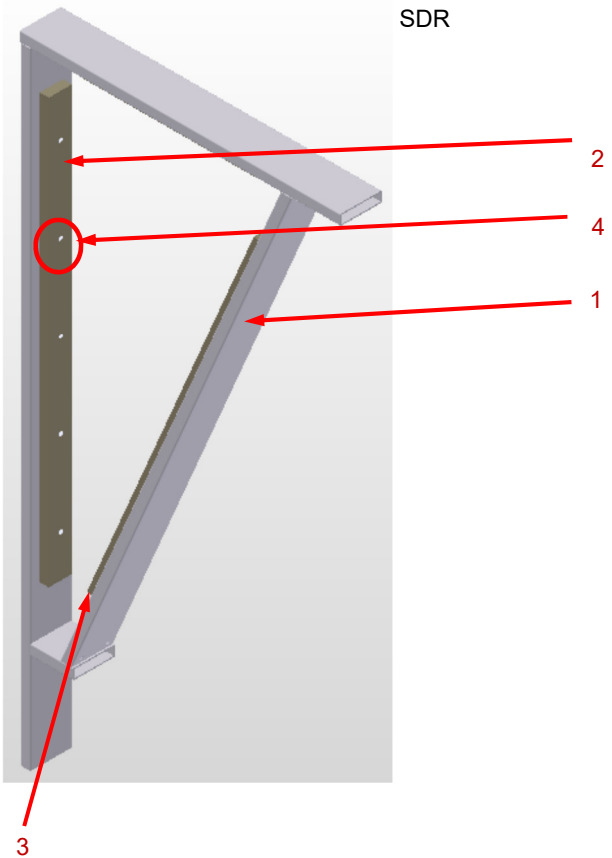

No.	Name	Article number
1	Frame SDR 150 I 75	785140
2	Finply 21X54X1000	770617
3	Finply 21X54X400	770616
4	TSS-Torx 6X40	024540









Valid for:

Triangular frame SDR	361021
Triangular frame SDR	361022

PERI Rental Criteria

SKYDECK







Frame	Description	Instruction	Billing Condition	Type
	<p>21.36 Crack in welding</p>		 088273	
	<p>21.37 Finply damaged</p>			

PERI Rental Criteria

SKYDECK



Deformation	Description	Instruction	Billing Condition	Type
	<p>21.38 Frame bent</p> <ul style="list-style-type: none"> ■ ≥ 3 mm 			

PERI Rental Criteria

SKYDECK



Wall holder SWH-2	No.	Name	Article number
-------------------	-----	------	----------------

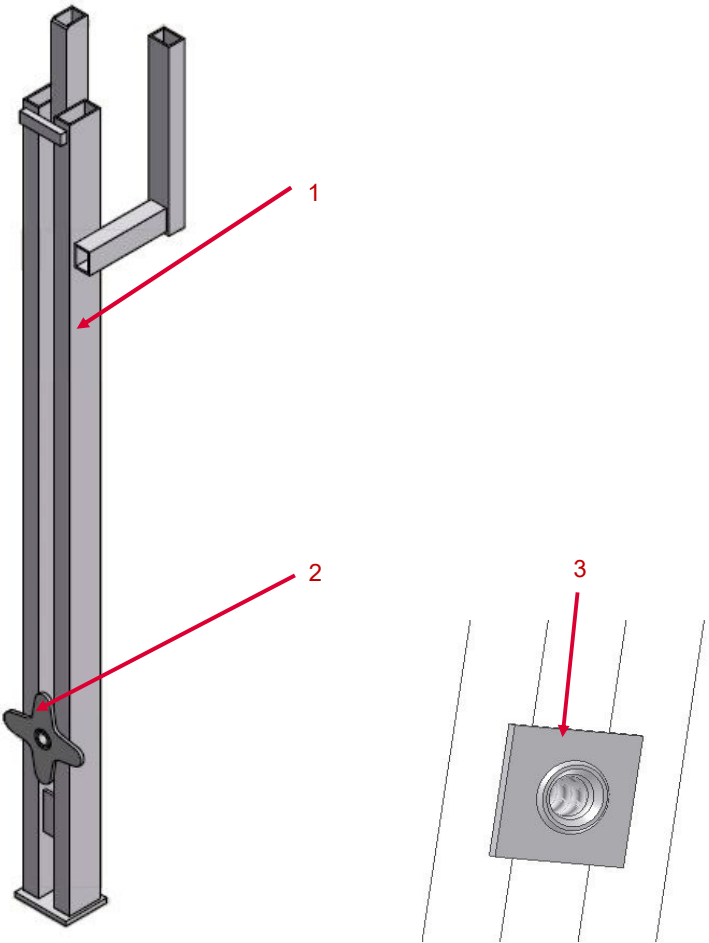

1	Skydeck-Wall holder SWH-2	
2	Star nut	715255
3	Plate	755204

Valid for:







SWH-2

061051

PERI Rental Criteria

SKYDECK



Deformation	Description	Instruction	Billing Condition	Type
	21.39 SWH-2 deformed	<ul style="list-style-type: none"> ■ Tube deformed   		
	<ul style="list-style-type: none"> ■ Or star nut and plate deformed 	 <ul style="list-style-type: none"> 715251 755204 		

PERI Rental Criteria

SKYDECK



SKY Anchor (131032)	No.	Name	BORNACK Article number
---------------------	-----	------	------------------------

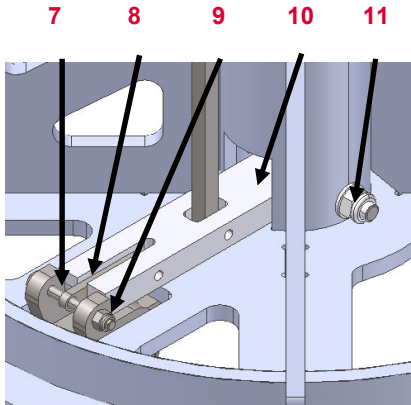
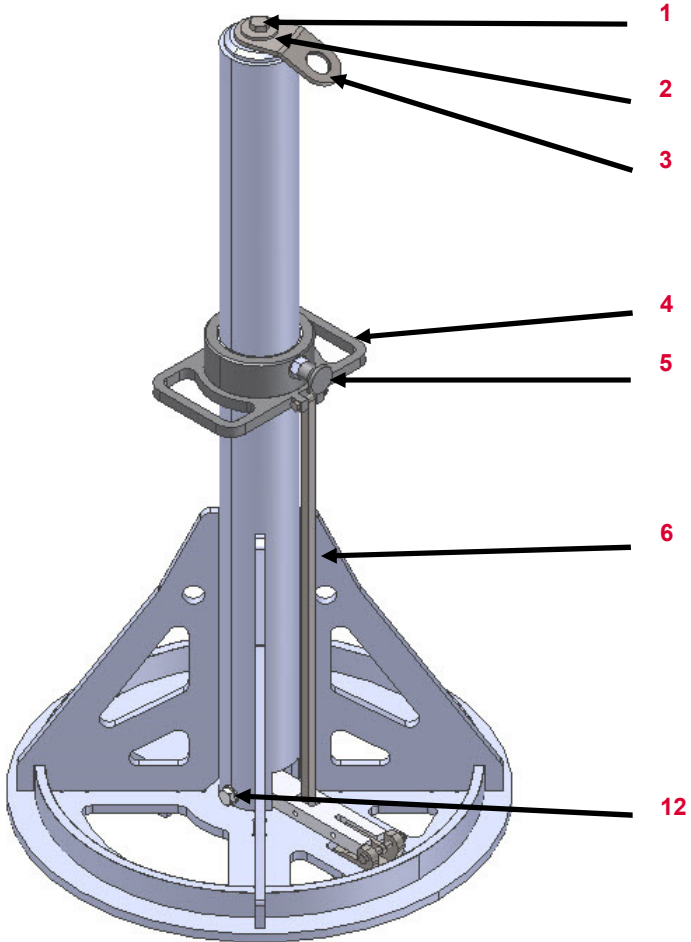















1	Bolt	1003163
2	Washer	1000070
3	Anchorage Point	1004255
4	Locking Sleeve	1004266
5	Locating Pin	1004267
6	Rod	1004254
7	Bolt	1004260
8	Plate	1004265
9	Nut	1004261
10	Locking Plate	1004263
11	Nut	1004028
12	Bolt	1004262

PERI Rental Criteria

SKYDECK



SKY Anchor (131032)	Description	Instruction	Billing Condition	Type
	21.51 Anchorage point			
	<ul style="list-style-type: none"> <li data-bbox="846 518 1294 614">■ Missing 			
	<ul style="list-style-type: none"> <li data-bbox="846 678 1294 774">■ Or bent 			
	21.52 Screw Washer			
	<ul style="list-style-type: none"> <li data-bbox="846 1037 1294 1133">■ Missing 			
	<ul style="list-style-type: none"> <li data-bbox="846 1197 1294 1292">■ Or damaged 			

PERI Rental Criteria

SKYDECK



SKY Anchor (131032)	Description	Instruction	Billing Condition	Type
	<p>21.53 Type plate</p> <ul style="list-style-type: none"> ■ Missing 			
	<ul style="list-style-type: none"> ■ Or not readable 			
	<p>21.54 Safety bolt</p> <ul style="list-style-type: none"> ■ Missing 			
	<ul style="list-style-type: none"> ■ Or function not available 			

PERI Rental Criteria

SKYDECK



SKY Anchor (131032)	Description	Instruction	Billing Condition	Type
	21.55 Reinforcement Plates bent	<ul style="list-style-type: none"> ■ Function given And welding not damaged 		
	<ul style="list-style-type: none"> ■ Or welding damaged 			
	<ul style="list-style-type: none"> ■ Or function disturbed 			
	21.56 Moveable parts bent	<ul style="list-style-type: none"> ■ Function still given 		
	<ul style="list-style-type: none"> ■ Or function disturbed 			

PERI Rental Criteria

SKYDECK



Platform SDB

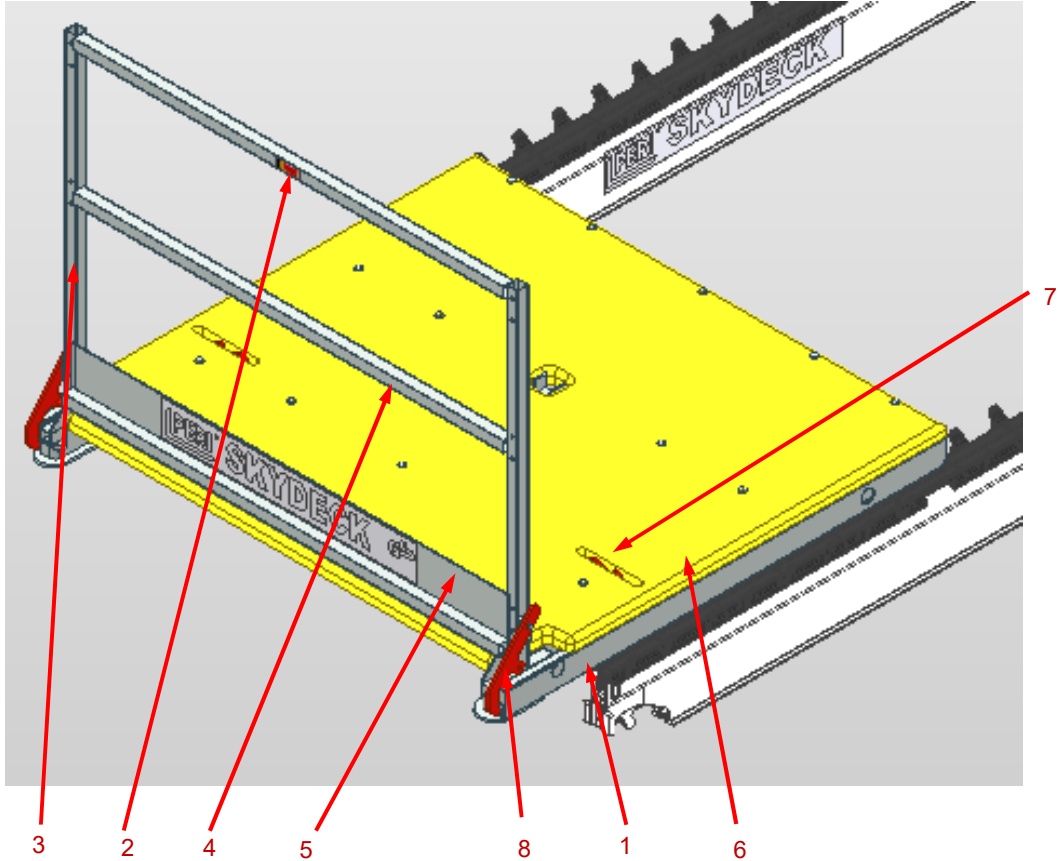









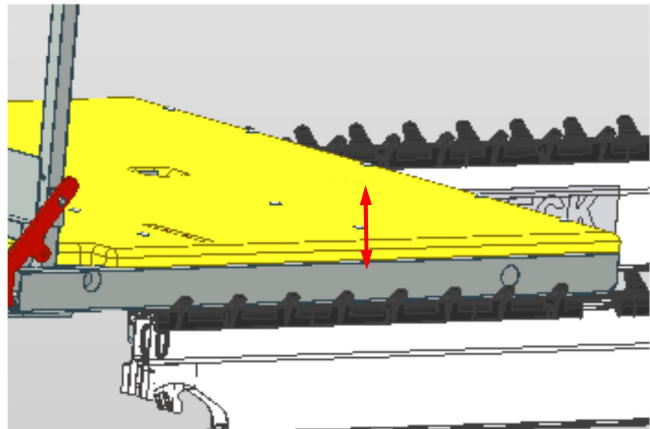

No.	Name	Article number
1	Frame platform SDB	
2	Guard rail SDB	
3	Vertical tube	
4	Horizontal tube	
5	Toeboard	
6	Board SDB	
7	Crane eye	700703
8	Safety handrail le. l re.	700667 700666

Valid for:	
Platform SDB 150	061060
Platform SDB 225	061061
Platform SDB 300	061062

PERI Rental Criteria

SKYDECK











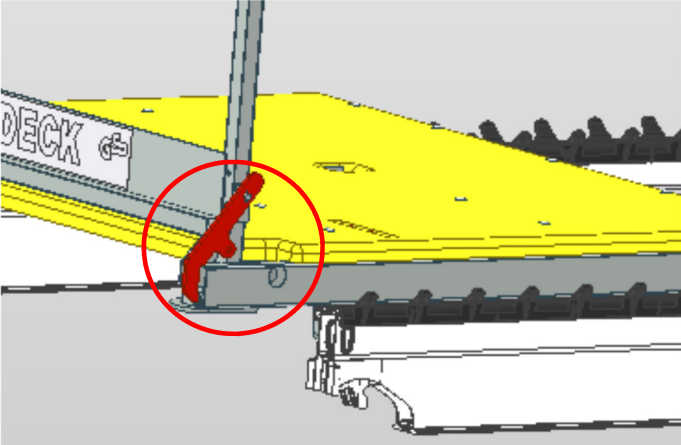



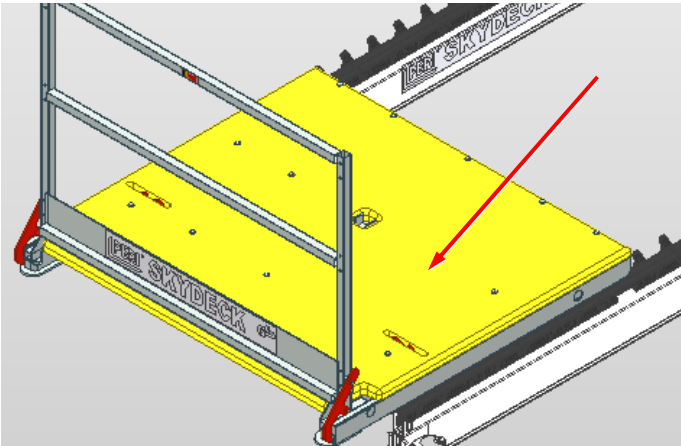



Platform	Description	Instruction	Billing Condition	Type	
	21.40 Frame bent				
	21.41 Handrail bent	<ul style="list-style-type: none"> <li data-bbox="875 1086 1093 1112"> Vertical tube bent <li data-bbox="875 1230 1151 1256"> Or horizontal tube bent 	<ul style="list-style-type: none"> <li data-bbox="1305 1070 1592 1129">  061063 (SDB 150) 061064 (SDB 225) 061065 (SDB 300) <li data-bbox="1305 1198 1592 1289">  061063 (SDB 150) 061064 (SDB 225) 061065 (SDB 300) 	<ul style="list-style-type: none"> <li data-bbox="1805 1038 2040 1129">  088322 (150) 088323 (225) 088324 (300) <li data-bbox="1805 1198 2040 1289">  088322 (150) 088323 (225) 088324 (300) 	<ul style="list-style-type: none"> <li data-bbox="2092 1070 2159 1139">  <li data-bbox="2092 1214 2159 1289"> 

PERI Rental Criteria

SKYDECK



Platform	Description	Instruction	Billing Condition	Type
	21.42 Safety handrail bent missing	 700667  700666	 088320	
	21.43 Board <ul style="list-style-type: none"> ■ Worn ■ Or damaged by force 	 061066 (SDB 150)  061067 (SDB 225)  061068 (SDB 300)		
		 061066 (SDB 150)  061067 (SDB 225)  061068 (SDB 300)	 088325  088326  088327	

PERI Rental Criteria

SKYDECK



Platform	Description	Instruction	Billing Condition	Type
----------	-------------	-------------	-------------------	------

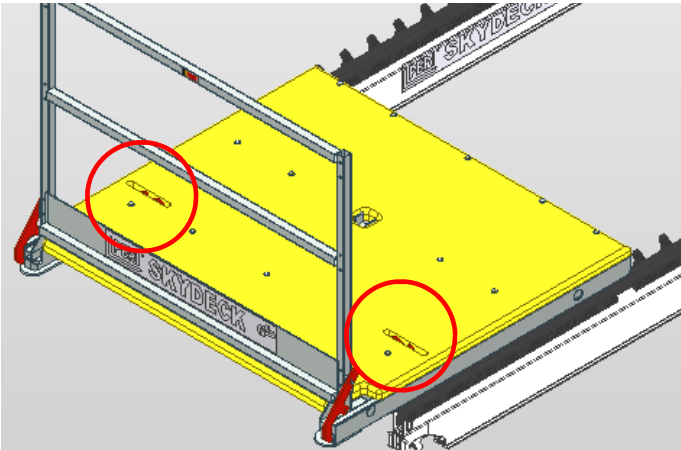

21.44 Crane eye bent | missing



700703

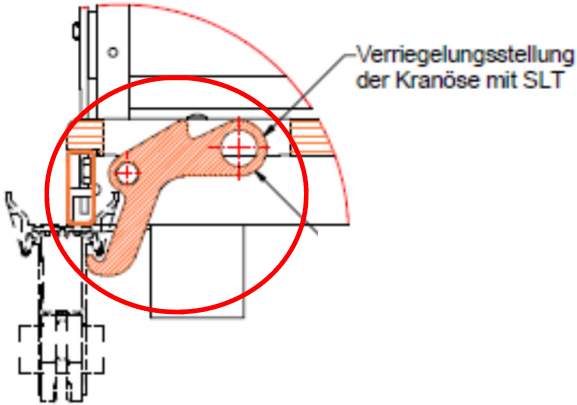

PERI Rental Criteria

SKYDECK



Stripping Cart (035500)	No.	Name	Article number
-------------------------	-----	------	----------------























1	„Alu Klappeinheit“	035503
2	Working platform	035506
3	Scaffolding tube	035501
4	Roller	035508

PERI Rental Criteria

SKYDECK



Stripping Cart (035500)	Description	Instruction	Billing Condition	Type
	21.45 Toe board			
	<ul style="list-style-type: none"> ■ Worn 	 		
	<ul style="list-style-type: none"> ■ Or cut 	 		
<ul style="list-style-type: none"> ■ Or holes in board 	 			
	21.46 Connector			
	<ul style="list-style-type: none"> ■ Bent (without damage of base material) 			
<ul style="list-style-type: none"> ■ Or damaged (with damage of base material) 	 			

PERI Rental Criteria

SKYDECK



Stripping Cart (035500)	Description	Instruction	Billing Condition	Type
-------------------------	-------------	-------------	-------------------	------



21.47 Roller

- Worn
- Or damaged by force



21.48 Scaffolding tube bent

















- ≤ 5 mm
- Or > 5 mm



PERI Rental Criteria

Glossary Icons



Icon	Significance	Icon	Significance	Icon	Significance
	Not Ok– material is scrap		Billing necessary (customer)		Optical damage
	OK– material stays in rental park		No Billing necessary		Functional damage
	Scrap material– it's not permitted to hand out the material because of safety aspects		Shorten the material		Functional damage— it's not permitted to hand out the material
	Repair according to instruction		Mark the material		Static damage— it's not permitted to hand out the material
	Fix material cold– Afterwards check weld seams and bordering components		Replace damaged material		
	Repair after local economic efficiency calculation		Replace missing material		
	Clean the material				