

PERI Rental Criteria

PERI UP Access



Contact

PERI GmbH
Formwork Scaffolding
Engineering
 P.O. Box 1264
 89264 Weissenhorn, Germany
 Phone +49 (0) 7309.950-0
 Fax +49 (0) 7309.951-0
rental-criteria@peri.de

Content	Page
Staircase	2
Stair Steps	7
Stair Stringer	10
Handrail	13
Stringer Frame End Guardrail Post	18
Ledger with Lap	20
Landing Brace	24
Steel Decks	25
Glossary	33

Changes	Date Initial	Page
New Version	06/2017 fw	

PERI Rental Criteria

PERI UP Access



Staircase UAS

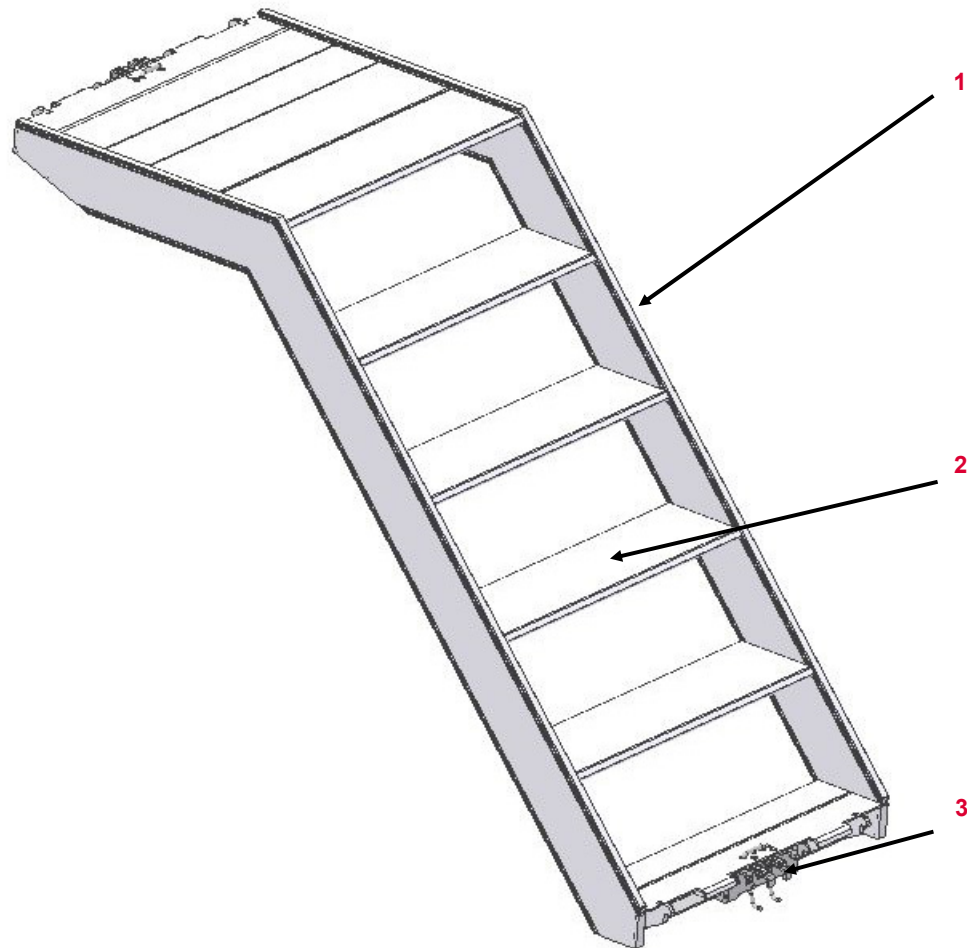













Nr.	Description	Article number
1	Side profile	
2	Stairs	
3	Connection Bracket	

Valid for	
Staircase UAS 250/200	100737
Staircase UAS 300/200	100738
Staircase UAS 75x75/50	113228
Staircase UAS 75x150/50 T	111087
Staircase UAS 75x150/50 S	111095
Staircase UAS 75x150/100	111103
Staircase UAS 75x150/100 S	114536
Staircase UAS 75x250/200	111117
Staircase UAS 75X300/200	111124

PERI Rental Criteria

PERI UP Access



Staircase UAS	Description	Instruction	Billing condition	Type
	<p>33.30.01 Crack near welding</p> <ul style="list-style-type: none"> ■ < 20 mm ■ > 20 mm 	<ul style="list-style-type: none">    	<ul style="list-style-type: none">   	<ul style="list-style-type: none">  
	<p>33.30.02 Crack through welding</p>	 		

PERI Rental Criteria

PERI UP Access



Staircase UAS	Description	Instruction	Billing condition	Type
---------------	-------------	-------------	-------------------	------



33.30.03 Crack in base (Step broken out)

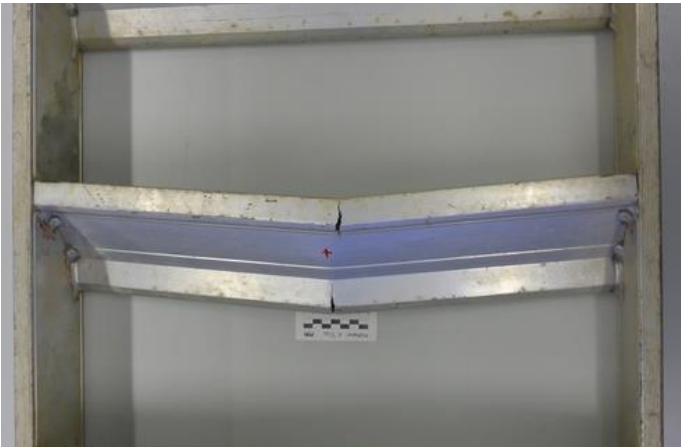

33.30.04 Crack in step



PERI Rental Criteria

PERI UP Access



Staircase UAS	Description	Instruction	Billing condition	Type
---------------	-------------	-------------	-------------------	------



33.30.05 Local Deformation at beginning | end of staircase



33.30.06 Dents in side profile

























- Without cracks in material or welding



PERI Rental Criteria

PERI UP Access



Stair Stringer UA (114731 109219)	Description	Instruction	Billing condition	Type
	<p>33.30.07 Hinge bent</p> <ul style="list-style-type: none"> ■ If possible ■ Or if no longer possible ■ Or if broken 	<ul style="list-style-type: none">      	<ul style="list-style-type: none">    	<ul style="list-style-type: none">   
	<p>33.30.08 Dents in profile</p> <ul style="list-style-type: none"> ■ $\leq \varnothing 3$ cm and edges not affected ■ Or $> \varnothing 3$ cm ■ Or edges affected 	<ul style="list-style-type: none">       	<ul style="list-style-type: none">    	<ul style="list-style-type: none">   

PERI Rental Criteria

PERI UP Access



Stair Step	Nr.	Description	Article number
------------	-----	-------------	----------------

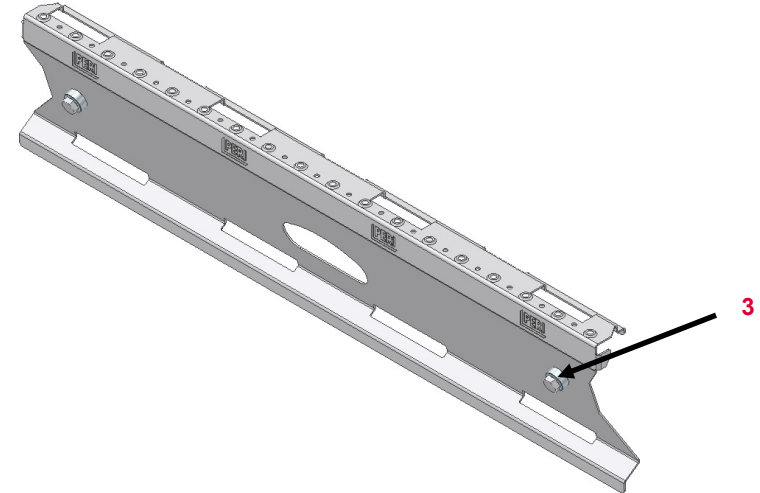
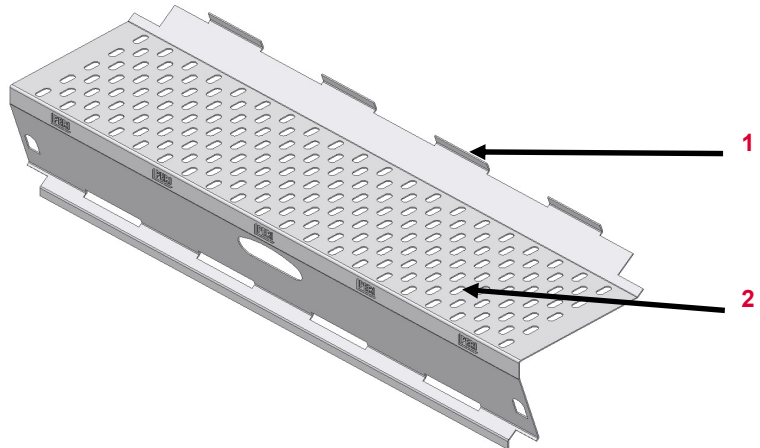















1	Connection Bracket	
2	Profile	
3	Hex Bolt M 12x35	780156

Valid for	
Stair Step UAR 100	109198
Stair Step UAR 125	114621
End Step UAE 100	109208
End Step UAE 125	114180

PERI Rental Criteria

PERI UP Access















Stair Steps	Description	Instruction	Billing condition	Type
	33.30.09 Connection bracket bent	<ul style="list-style-type: none"> ■ Connection possible   		
	<ul style="list-style-type: none"> ■ Or connection no longer possible 			
	<ul style="list-style-type: none"> ■ Or Re-bending no longer possible 	 		
	33.30.10 Bolt missing			

PERI Rental Criteria

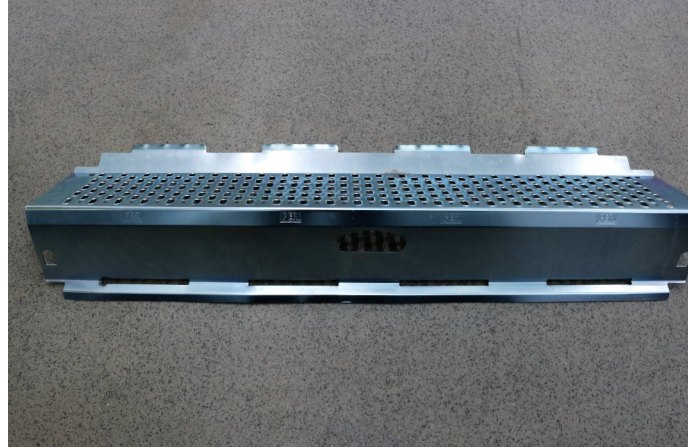
PERI UP Access



Stair Steps	Description	Instruction	Billing condition	Type
	<p>33.30.11 Bent</p> <ul style="list-style-type: none"> ■ If possible ■ Or if no longer possible 	<p>If possible: </p> <p>Or if no longer possible:  </p>	<p>If possible: </p> <p>Or if no longer possible: </p>	<p>If possible: </p> <p>Or if no longer possible: </p>
	<p>33.30.12 Steps bent torn</p>	<p> </p>	<p></p>	<p></p>

PERI Rental Criteria

PERI UP Access



Stair Stringer UZS	Nr.	Description	Article number
--------------------	-----	-------------	----------------

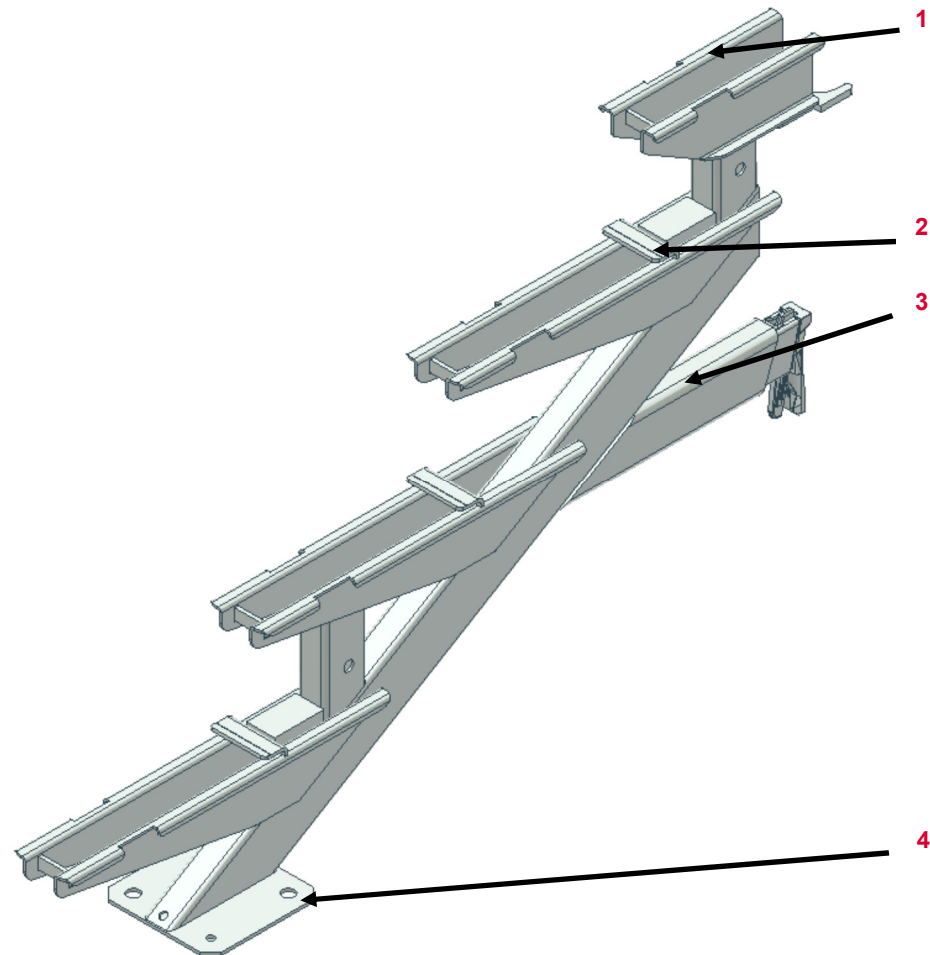

1	Step Profil
2	Bracket
3	Connection
4	End plate

Valid for	
Stair Stringer UZS 28/27	110258
Stair Stringer UZS 56/50	110242
Stair Stringer UZS 110/83	110249
Stair Stringer UZS 250/150	107448

PERI Rental Criteria

PERI UP Access



Stair Stringer UZS	Description	Instruction	Billing condition	Type
--------------------	-------------	-------------	-------------------	------

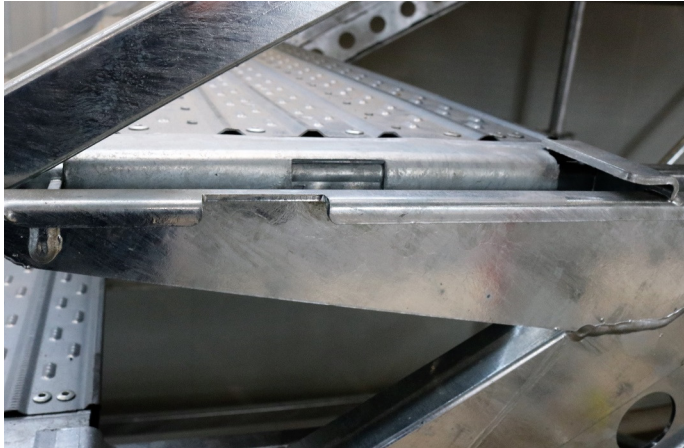

33.30.13 Stair profile bent

- Insertion of decking possible
- Or if re-bending possible
- Or if re-bending not possible

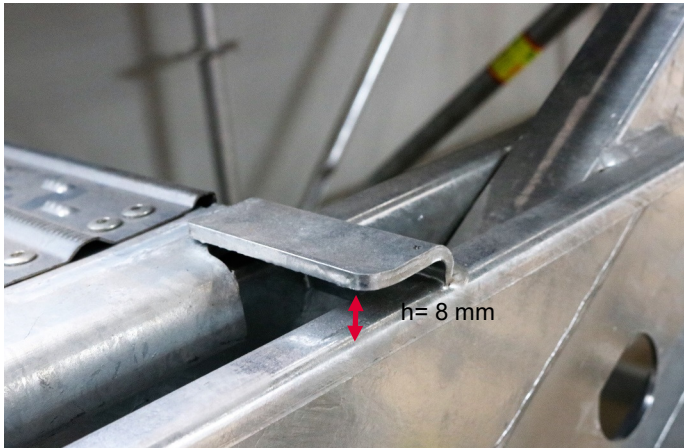

33.30.14 Bracket bent













- If possible
- Or if no longer possible



PERI Rental Criteria

PERI UP Access



Stair Stringer UZS	Description	Instruction	Billing condition	Type
	<p>33.30.15 End plate bent</p> <ul style="list-style-type: none"> ■ If possible ■ Or if welding cracked 	<p>    </p>	<p>   </p>	<p>   </p>
	<p>33.30.16 Wedge missing</p>	<p>   </p>	<p>  </p>	<p>  </p>

PERI Rental Criteria

PERI UP Access



Stair Guardrail Landing Guardrail Guardrail Frame	Nr.	Description	Article number
-------------------------------------------------------	-----	-------------	----------------

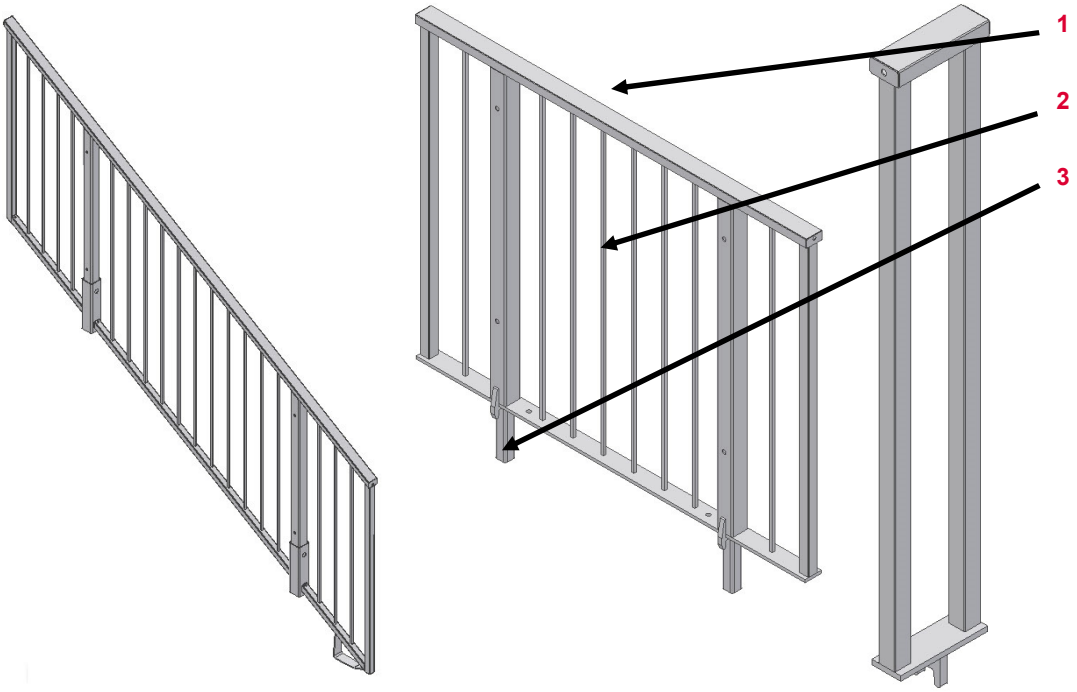





















1	Handrail
2	Strut
3	Connection bracket

Valid for	
Stair Guardrail UZG 56/50	110263
Stair Guardrail UZG 110/83	110270
Stair Guardrail UZG 250/150	108189
Landing Guardrail UZG 150	108190
Guardrail Frame UZG 25	108545

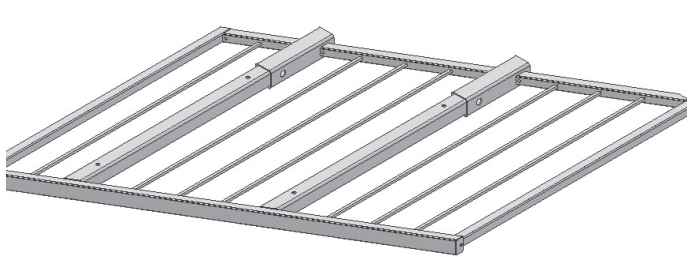
PERI Rental Criteria

PERI UP Access



Guard Rail	Description	Instruction	Billing condition	Type
	<p>33.30.17 Junction for Guardrail post bent</p> <ul style="list-style-type: none"> ■ Inserting possible ■ Or if not possible 	<ul style="list-style-type: none">    	<ul style="list-style-type: none">   	<ul style="list-style-type: none">  
	<p>33.30.18 Strut bent</p> <ul style="list-style-type: none"> ■ No damage to welding ■ Or with damage to welding 	<ul style="list-style-type: none">   	<ul style="list-style-type: none">   	<ul style="list-style-type: none">  
	<p>33.30.19 Stair Guardrail bent</p> <ul style="list-style-type: none"> ■ < permitted bent (L/250) ■ Or > 5 mm (110/83) ■ Or > 10 mm (250/150) 	<ul style="list-style-type: none">   	<ul style="list-style-type: none">   	<ul style="list-style-type: none">  

PERI Rental Criteria

PERI UP Access



Guardrail Connector (108387;108218)	Description	Instruction	Billing condition	Type
-------------------------------------	-------------	-------------	-------------------	------



33.30.20 Cylinder Bolt

- Missing
- Damaged (no longer movable) due to violece



33.30.21 Bent



















- Guard Rails are connectable
- Guard Rails are no longer connectable



PERI Rental Criteria

PERI UP Access















Guardrail Transition	Description	Instruction	Billing condition	Type
	33.30.22 Parts of Guardrail broken off	<ul style="list-style-type: none"> <li data-bbox="846 596 1294 651">■ No risk of injury  		
	<ul style="list-style-type: none"> <li data-bbox="846 740 1294 788">■ Risk of injury due to sharp edges 			
	<ul style="list-style-type: none"> <li data-bbox="846 884 1294 932">■ Optically no longer acceptable 			
	33.30.23 Parts of sleeve broken off	<ul style="list-style-type: none"> <li data-bbox="846 1075 1294 1129">■ Attaching possible  		
	<ul style="list-style-type: none"> <li data-bbox="846 1219 1294 1251">■ Or if no longer possible 	 		

PERI Rental Criteria

PERI UP Access



Stair Guardrail UAG UAH (100742, 100830)	Description	Instruction	Billing condition	Type
	33.30.24 Guardrail attachment bent		 088244	
	33.30.25 Fork bent and rusty	 Renew Zinc layer	 088244	
	33.30.26 Missing bracket in hinge	 100826 (Bracket UAH)		

PERI Rental Criteria

PERI UP Access



Stringer Frame End Guardrail Post	Nr.	Description	Article number
-------------------------------------	-----	-------------	----------------

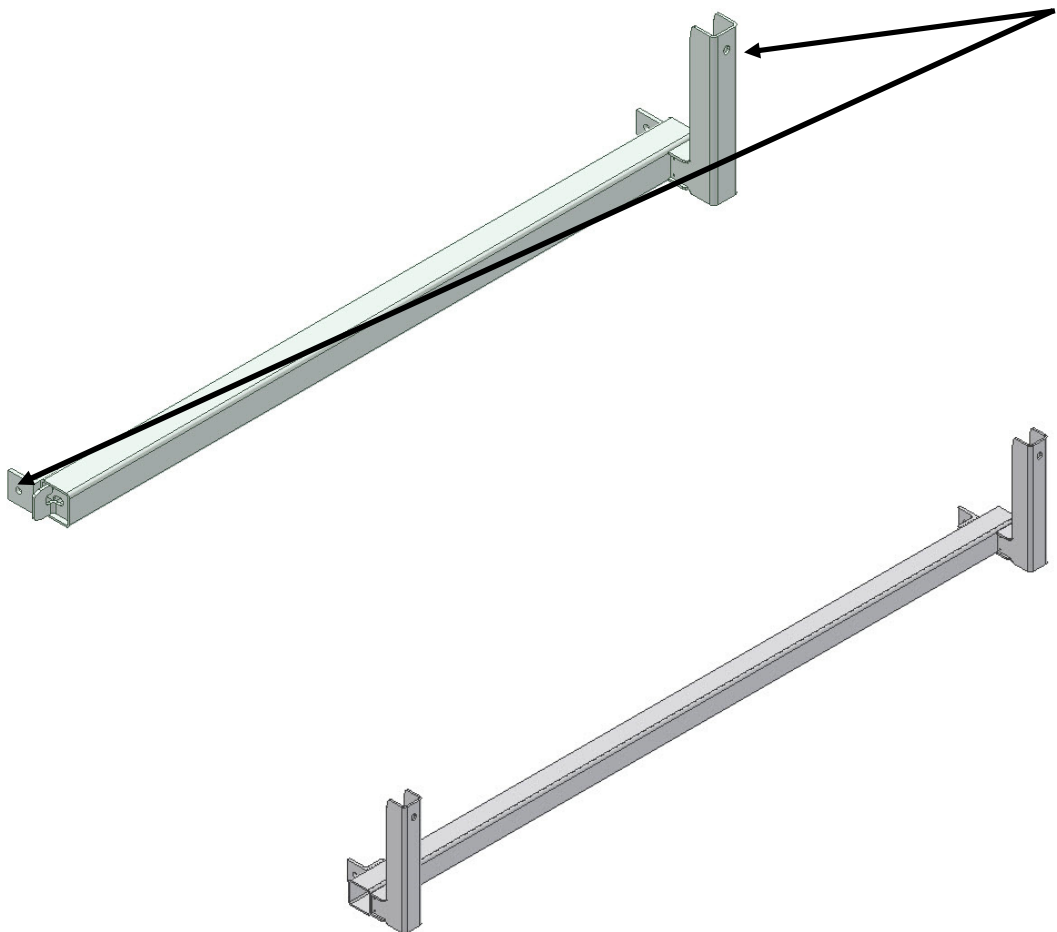

1	1	Junction	103339
2	2	Horizontal Tube	

Valid for	
Stringer Frame UZF 150	107162
Stringer Frame UZF 200	106582
Stringer Frame UZF 250	106583
End Guardrail Post UZE 150	108536
End Guardrail Post UZE 200	107178
End Guardrail Post UZE 250	108544

PERI Rental Criteria

PERI UP Access



Stringer Frame End Guardrail Post	Description	Instruction	Billing condition	Type
-------------------------------------	-------------	-------------	-------------------	------



33.30.27 Junctions bent

- If possible
- Or if no longer possible

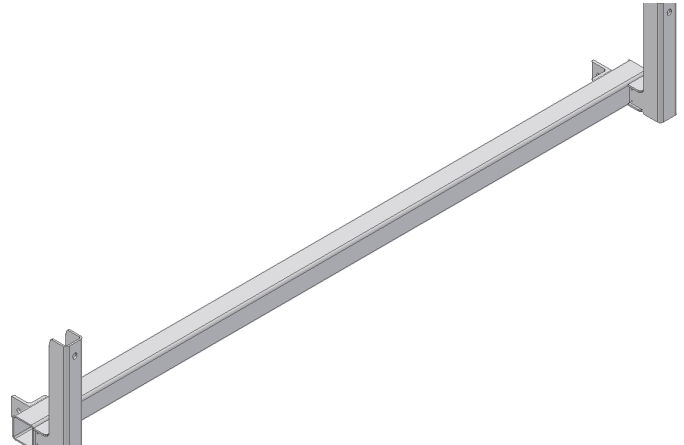

33.30.28 Horizontal Pipe bent

- Insertion of stair guardrail possible
- Or insertion no longer possible



PERI Rental Criteria

PERI UP Access



Ledger with Lap (106626)	Description	Instruction	Billing condition	Type
--------------------------	-------------	-------------	-------------------	------



33.30.29 Local dent in profile

- Edges not affected



33.30.30 Wedge opening torn out | wedge missing



PERI Rental Criteria

PERI UP Access



Ledger with Lap (106626)	Description	Instruction	Billing condition	Type
--------------------------	-------------	-------------	-------------------	------



33.30.31 Profile bent at edge

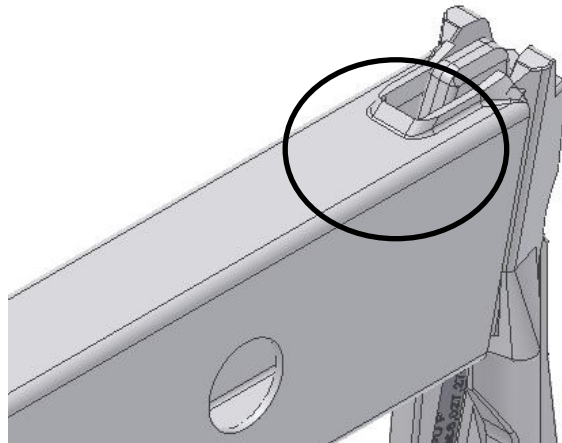

33.30.32 Dent at hook

- If possible
- Or if no longer possible
- Or crack in material



088244



PERI Rental Criteria

PERI UP Access



Ledger with Lap (106626)	Description	Instruction	Billing condition	Type
--------------------------	-------------	-------------	-------------------	------



33.30.33 Hole dented

- If original geometry of hole unchanged
- Or if changed
- Or cracks in material



088244



















33.30.34 Profile bent



PERI Rental Criteria

PERI UP Access



Ledger with Lap (106626)	Description	Instruction	Billing condition	Type
	33.30.35 Post junction bent			
	<ul style="list-style-type: none"> ■ If possible 			
	<ul style="list-style-type: none"> ■ If no longer possible 			
<ul style="list-style-type: none"> ■ Or cracks in welding 				
	33.30.36 Bolts Nuts			
	<ul style="list-style-type: none"> ■ Missing 	 024900 (Bolt) 781053 (Nut)		
<ul style="list-style-type: none"> ■ Or damaged due to violence 	 024900 (Bolt) 781053 (Nut)			

PERI Rental Criteria

PERI UP Access



Landing Brace (108034; 108000; 108172; 108179)	Description	Instruction	Billing condition	Type
------------------------------------------------	-------------	-------------	-------------------	------



33.30.37 Junction bent

- If possible and Insertion possible after cold repair
- If no longer possible
- Or welding damaged



33.30.38 Bracing piece bent

- Connection possible and no damage to welding
- Or welding damaged
- Or connection not possible



PERI Rental Criteria

PERI UP Access



Steel Deck UDS Public	Nr.	Description	Article number
-----------------------	-----	-------------	----------------

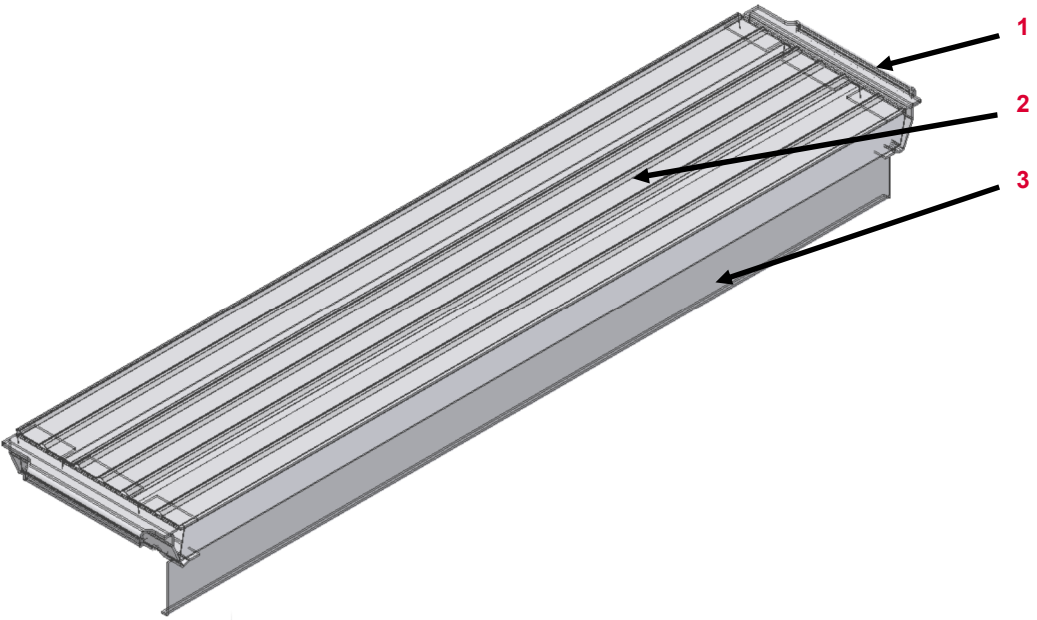















1	Connection Hinge	103339
2	Decking UDS	
3	Sheet UDS	

Valid for	
Steel Deck UDS 32x150 Public	106585
Steel Deck UDS 32x200 Public	106586
Steel Deck UDS 32x250 Public	106587

PERI Rental Criteria

PERI UP Access











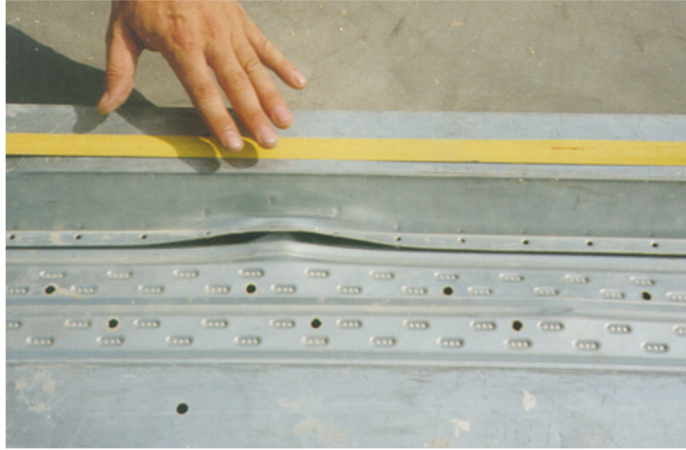





Steel Deck UDS Public	Description	Instruction	Billing condition	Type
	<p>33.30.39 Local dent in side profile</p> <ul style="list-style-type: none"> ■ No deformation of Tox- Connection 	 		
	<p>33.30.40 Dent in side profile</p> <ul style="list-style-type: none"> ■ Insertion of decking easily possible 	 		
	<p>33.30.41 Dent in end of decking</p>	 		

PERI Rental Criteria

PERI UP Access

















Steel Deck UDS Public	Description	Instruction	Billing condition	Type
	<p>33.30.42 Dent in decking surface</p> <ul style="list-style-type: none"> ■ > 10 mm ■ Tox connection damaged 	<p>   </p> <p>   </p>	<p>  </p> <p>  </p>	<p>  </p> <p>  </p>
	<p>33.30.43 Dent in decking side</p> <ul style="list-style-type: none"> ■ > 10 mm 	<p>   </p>	<p>  </p>	<p>  </p>

PERI Rental Criteria

PERI UP Access



















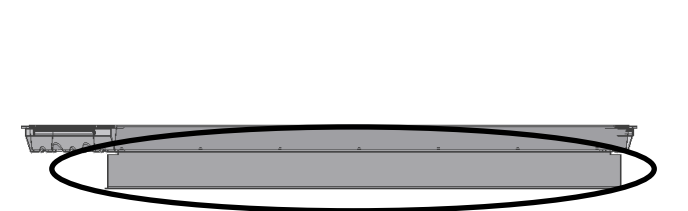

Steel Deck UDS Public	Description	Instruction	Billing condition	Type
	33.30.44 Hole in decking	<ul style="list-style-type: none"> <li data-bbox="844 564 1285 596">■ ≤ 10 mm and rib undamaged 		
	<ul style="list-style-type: none"> <li data-bbox="844 660 1285 692">■ Or > 10 mm <li data-bbox="844 708 1285 740">■ Or rib damaged 			
	33.30.45 Welded holes in decking	<ul style="list-style-type: none"> <li data-bbox="844 895 1285 927">■ ≤ Ø 25 mm 		
	<ul style="list-style-type: none"> <li data-bbox="844 1038 1285 1070">■ Edge profile affected <li data-bbox="844 1086 1285 1118">■ Rib profile affected 			
	33.30.46 Steel deck with rust on the deck	<ul style="list-style-type: none"> <li data-bbox="1285 1166 1787 1230">■ Rust only on surface layer 		

PERI Rental Criteria

PERI UP Access



Steel Deck UDS Public	Description	Instruction	Billing condition	Type
	33.30.47 Broken/missing rivets			
	33.30.48 Bracket of lifting protection <ul style="list-style-type: none"> ■ Bent ■ Or broken 	<ul style="list-style-type: none">   	<ul style="list-style-type: none">   	<ul style="list-style-type: none">  
	33.30.49 Sheet bent <ul style="list-style-type: none"> ■ If possible ■ Or if no longer possible 	<ul style="list-style-type: none">   	<ul style="list-style-type: none">   	<ul style="list-style-type: none">  
<ul style="list-style-type: none"> 108476 (150) 108531 (200) 108537 (250) 				

PERI Rental Criteria

PERI UP Access



Gap Filler Landing Cover Plate UZD	Nr.	Description	Article number
--------------------------------------	-----	-------------	----------------

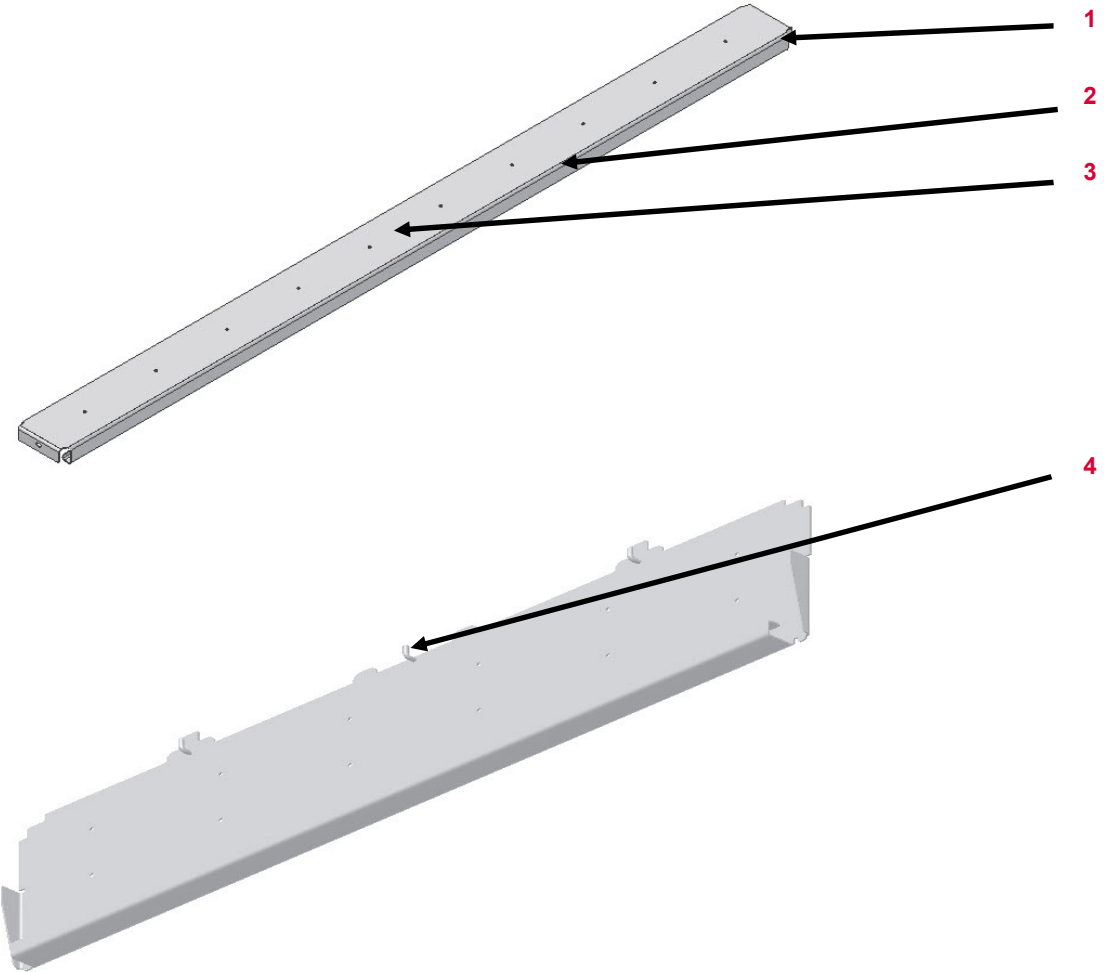

















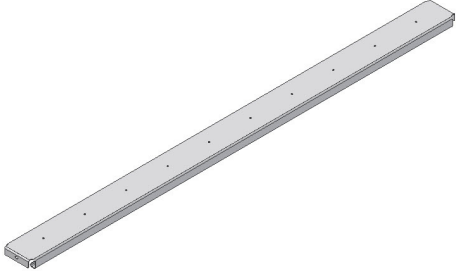



1	1	Hinge
2	2	Side profile
3	3	Deck
4	4	Hook

Valid for	
Gap filler UZD 150/16	107981
Gap filler UZD 150/31	107986
Gap filler UZD 150/37	107977
Gap filler UZD 200/16	108010
Gap filler UZD 250/16	108011
Landing Cover Plate UZD 150/25	108412

PERI Rental Criteria

PERI UP Access



Gap Filler Landing Cover Plate UZD	Description	Instruction	Billing condition	Type
	33.30.50 Hook bent			
	<ul style="list-style-type: none"> <li data-bbox="875 568 1014 592">■ If possible <li data-bbox="875 711 1151 735">■ Or if no longer possible 	<div data-bbox="1305 552 1373 619" style="text-align: center;">  </div> <div data-bbox="1305 691 1373 758" style="text-align: center;">  </div>	<div data-bbox="1805 552 1872 619" style="text-align: center;">  </div> <div data-bbox="1805 691 1872 758" style="text-align: center;">  </div>	<div data-bbox="2089 552 2157 619" style="text-align: center;">  </div> <div data-bbox="2089 691 2157 758" style="text-align: center;">  </div>
	33.30.51 Decking bent			
	<ul style="list-style-type: none"> <li data-bbox="875 903 1122 927">■ Connection possible <li data-bbox="875 1046 1133 1070">■ Or no longer possible 	<div data-bbox="1305 887 1373 954" style="text-align: center;">  </div> <div data-bbox="1305 1026 1373 1093" style="text-align: center;">  </div>	<div data-bbox="1805 887 1872 954" style="text-align: center;">  </div> <div data-bbox="1805 1026 1872 1093" style="text-align: center;">  </div>	<div data-bbox="2089 887 2157 954" style="text-align: center;">  </div> <div data-bbox="2089 1026 2157 1093" style="text-align: center;">  </div>
	33.30.52 Side profile bent			
	<ul style="list-style-type: none"> <li data-bbox="875 1265 1014 1289">■ If possible <li data-bbox="875 1361 1151 1385">■ Or if no longer possible 	<div data-bbox="1305 1233 1373 1300" style="text-align: center;">  </div> <div data-bbox="1305 1356 1373 1423" style="text-align: center;">  </div>	<div data-bbox="1805 1233 1872 1300" style="text-align: center;">  </div> <div data-bbox="1805 1356 1872 1423" style="text-align: center;">  </div>	<div data-bbox="2089 1233 2157 1300" style="text-align: center;">  </div> <div data-bbox="2089 1356 2157 1423" style="text-align: center;">  </div>

PERI Rental Criteria

PERI UP Access



Landing Link Panel UAB (101671)	Description	Instruction	Billing condition	Type
---------------------------------	-------------	-------------	-------------------	------

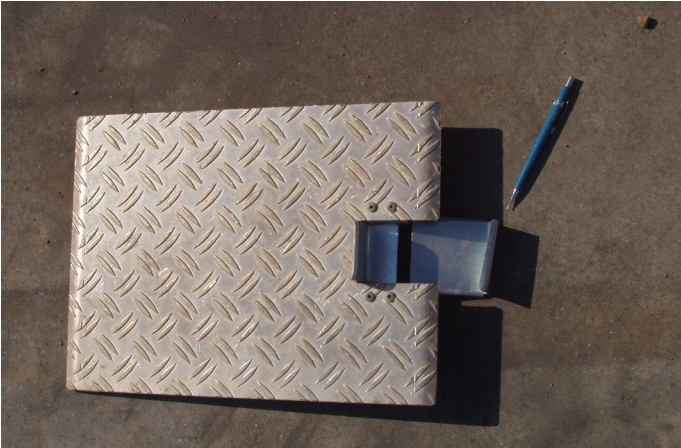

33.30.53 Connection sheet bent



088244



33.30.54 Landing Link Panel bent



















088244



PERI Rental Criteria

Glossary Icons



Icon	Significance	Icon	Significance	Icon	Significance
	Not Ok– material is scrap		Billing necessary (customer)		Optical damage
	OK– material stays in rental park		No Billing necessary		Functional damage
	Scrap material– it's not permitted to hand out the material because of safety aspects		Shorten the material		Functional damage— it's not permitted to hand out the material
	Repair according to instruction		Mark the material		Static damage— it's not permitted to hand out the material
	Fix material cold– Afterwards check weld seams and bordering components		Replace damaged material		
	Repair after local economic efficiency calculation		Replace missing material		
	Clean the material				