

PERI Rental Criteria

LIWA



Contact

PERI GmbH
Formwork Scaffolding
Engineering
 P.O. Box 1264
 89259 Weissenhorn, Germany
 Phone +49 (0) 7309.950-0
 Fax +49 (0) 7309.951-0
rental-criteria@peri.de

Content	Page	Changes made	Date Initia	Page
Frame	2	New version	11/2015 fw	
Articulated Corner	7			
Corner panel	10			
Wall thickness compensation	13			
Accessories	15			
Glossary	25			

PERI Rental Criteria

LIWA



Frame	No.	Name	Article number
-------	-----	------	----------------

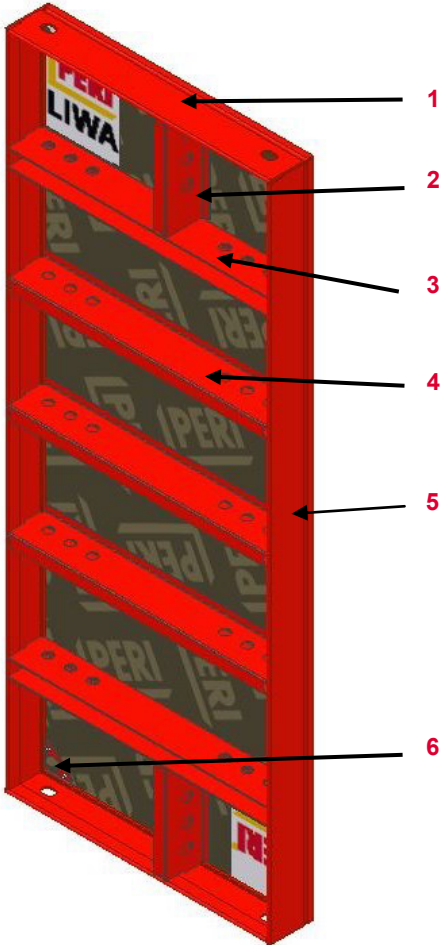

1	Front profile	
2	Top up brace	
3	Anchor brace	
4	Longitudinal brace	
5	Length profile	
6	Corner plate-2	767032

PERI Rental Criteria

LIWA



Article	Article number
Element LW 300x 75	116878
Element LW 300x 60	116906
Element LW 300x 50	116916
Element LW 300x 40	116923
Element LWM 300x 75	116984
Element LW 250x 75	117717
Element LW 250x 60	117721
Element LW 250x 50	117725
Element LW 250x 40	117730
Element LWM 250x 75	117738

Article	Article number
Element LW 150x 75	117013
Element LW 150x 60	117024
Element LW 150x 50	117107
Element LW 150x 40	117111
Element LWM 150x 75	117029
Element LW 75x 75	117125
Element LW 75x 60	117136
Element LW 75x 50	117140
Element LW 75x 40	117144
Element LWM 75x75	117146

PERI Rental Criteria

LIWA



Frame	Description	Instruction	Billing Condition	Type
-------	-------------	-------------	-------------------	------



28.70.01 Frame dent

- > 5 mm



A

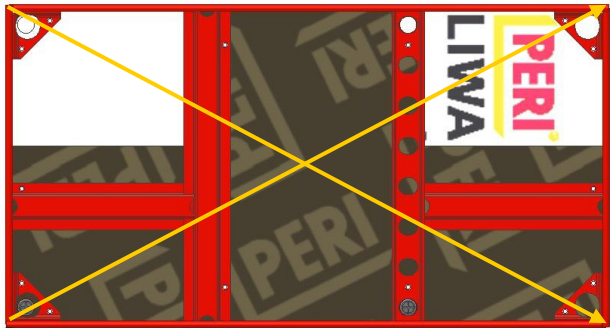

28.70.02 Frame bent diagonally















- Difference from A to B > 5 mm



PERI Rental Criteria

LIWA



Frame	Description	Instruction	Billing Condition	Type
	28.70.03 Profile bent			
	28.70.04 Braces bent kink			
	<ul style="list-style-type: none"> ■ Falls möglich ■ Oder falls nicht 	 	 	 
	28.70.05 Crack in welding			

PERI Rental Criteria

LIWA



Frame	Description	Instruction	Billing Condition	Type
	28.70.06 Corner plate dent			
	28.70.07 Front profile dent deformed			
	<ul style="list-style-type: none"> ■ If possible 			
	28.70.08 Length profile bent deformed			
	<ul style="list-style-type: none"> ■ If possible 			
	<ul style="list-style-type: none"> ■ Or if not possible 			

PERI Rental Criteria

LIWA



Articulated corner

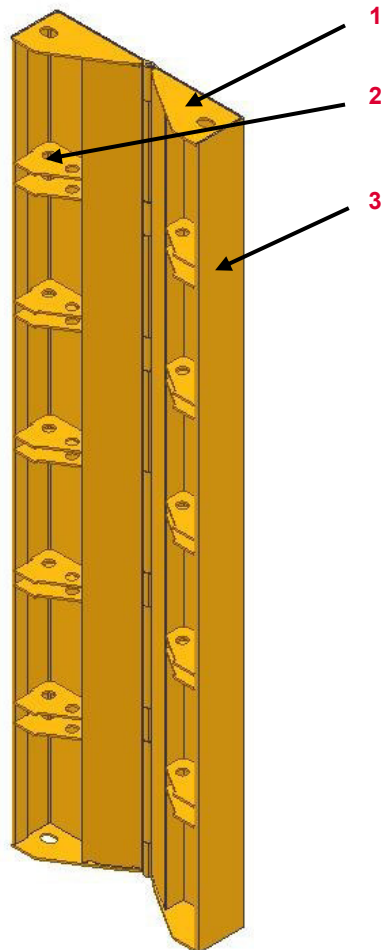











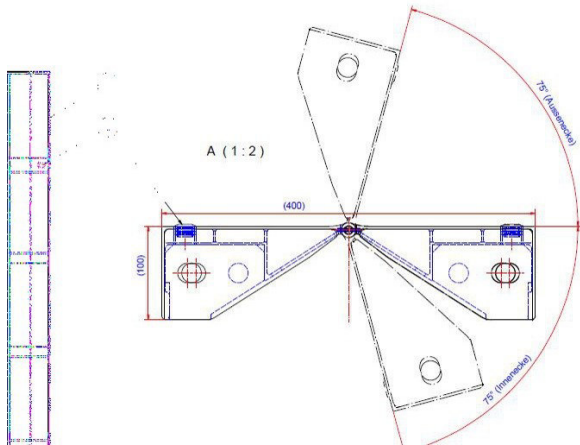

No.	Name	Article number
1	Cover plate	117202
2	Plate	117203
3	Profile	



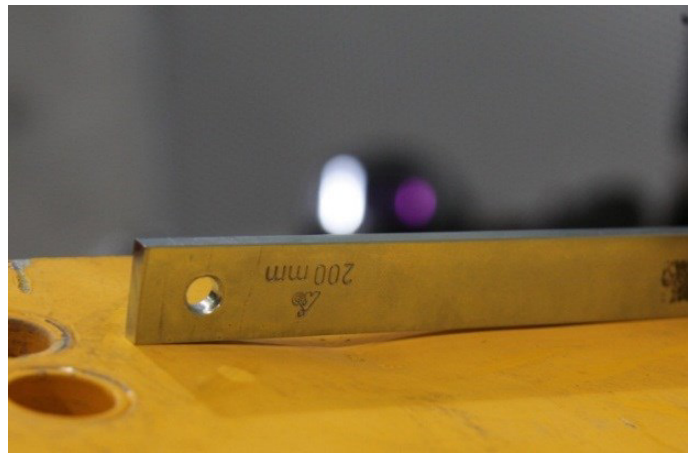







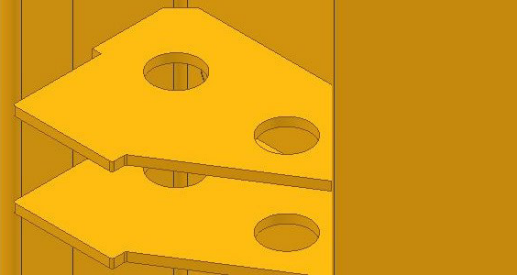

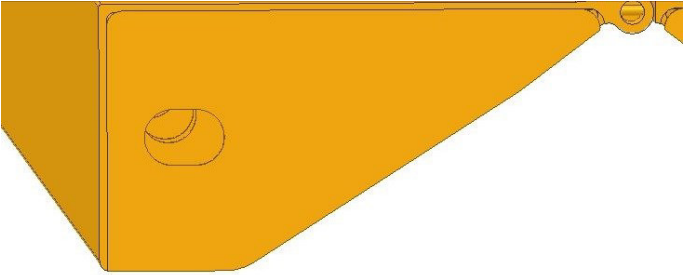

Gültig für Artikel	Artikelnummer
Articulated corner LIWA 300	117209
Articulated corner LIWA 250	124006
Articulated corner LIWA 150	117275

PERI Rental Criteria

LIWA

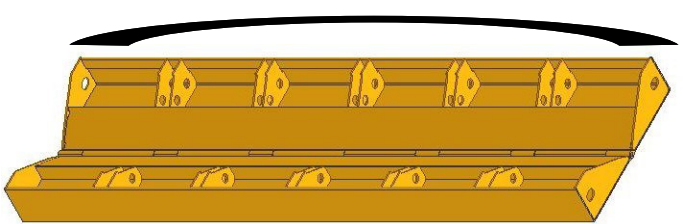

Articulated corner	Description	Instruction	Billing Condition	Type
	<p>28.70.09 Function not available</p> <ul style="list-style-type: none"> ■ If possible ■ Or if not possible 	<ul style="list-style-type: none">   	<ul style="list-style-type: none">   	<ul style="list-style-type: none">  
	<p>28.70.10 Dent in concrete surface</p> <ul style="list-style-type: none"> ■ ≤ 3 mm ■ Or > 3 mm 	<ul style="list-style-type: none">   	<ul style="list-style-type: none">   	<ul style="list-style-type: none">  

Articulated corner	Description	Instruction	Billing Condition	Type
	<p>28.70.11 Plaids bent deformed</p>			
	<p>28.70.12 Cover plate bent deformed</p> <ul style="list-style-type: none"> ■ If possible ■ Or if not possible 	<p>■ If possible</p>  <p>■ Or if not possible</p> 	<p>■ If possible</p>  <p>■ Or if not possible</p> 	<p>■ If possible</p>  <p>■ Or if not possible</p> 
	<p>28.70.13 Frame bent</p> <ul style="list-style-type: none"> ■ > 5 mm 			

PERI Rental Criteria

LIWA



Corner panel	No.	Name	Article number
--------------	-----	------	----------------

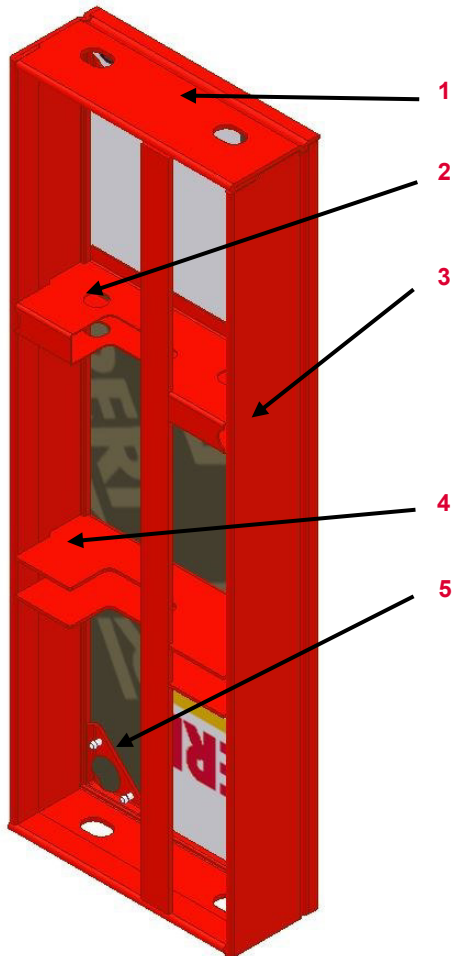

1	Front profile	116926
2	Length brace	117203
3	Length profile	
4	Anchor brace	
5	Corner plaid	767032

Valid for	Article number
Corner panel LW 300x 25	116930
Corner panel LW 250x 25	117736
Corner panel LW 150x 25	117510
Corner panel LW 75x 25	117541

PERI Rental Criteria

LIWA



Corner panel	Description	Instruction	Billing Condition	Type
--------------	-------------	-------------	-------------------	------

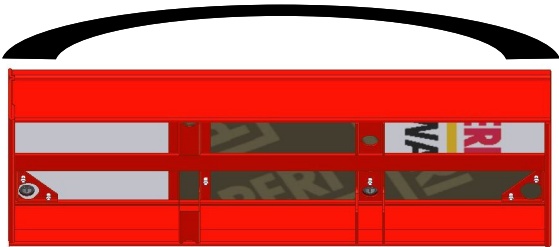

28.70.14 Element bent

- > 5 mm

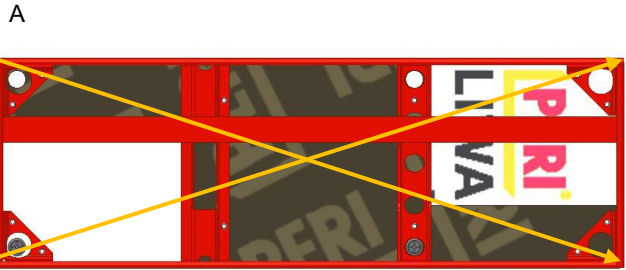

28.70.15 Frame dent diagonally

- Difference from A to B > 5 mm



PERI Rental Criteria

LIWA



Corner panel	Description	Instruction	Billing Condition	Type
	28.70.16 Anchor brace bent	<ul style="list-style-type: none"> ■ If possible 		
	<ul style="list-style-type: none"> ■ Or if not possible 			
	28.70.17 Length brace bent	<ul style="list-style-type: none"> ■ If possible 		
	<ul style="list-style-type: none"> ■ Or if not possible 			
	28.70.18 Frame brace bent	<ul style="list-style-type: none"> ■ If possible 		
	<ul style="list-style-type: none"> ■ Or if not possible 			

PERI Rental Criteria

LIWA



Wall thickness compensation	No.	Name	Article number
-----------------------------	-----	------	----------------

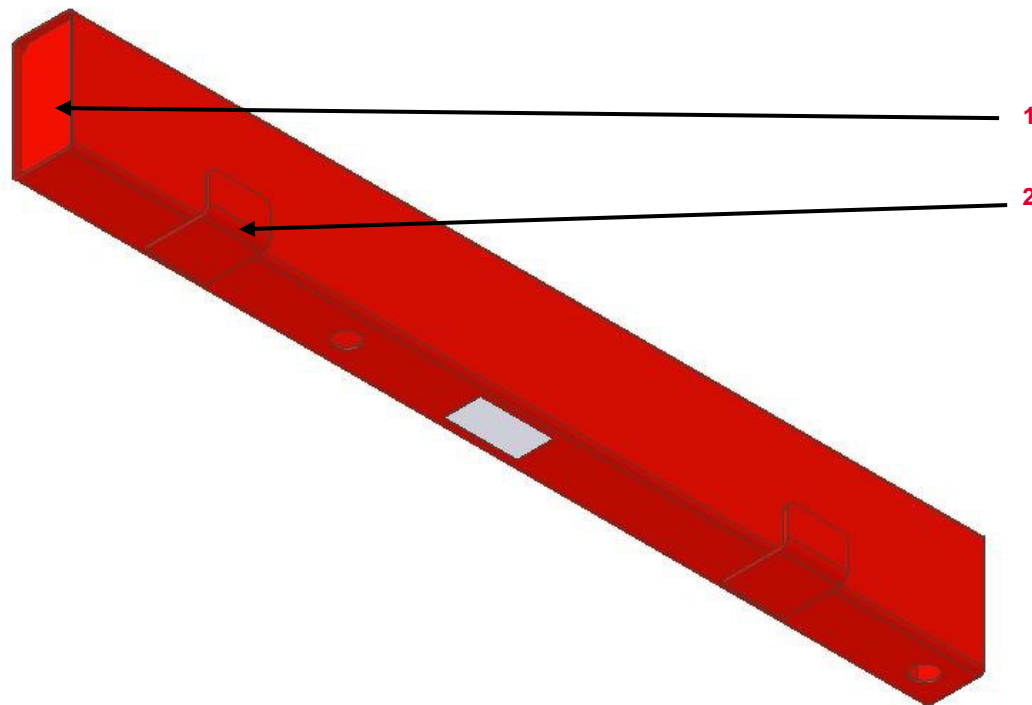





















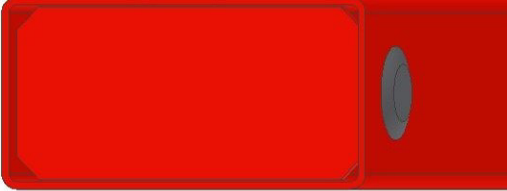

1	Cover plate	117361
2	Plate	117360

Valid for	Article number
Wall thickness compensation LW 300x 5	117364
Wall thickness compensation LW 250x 5	117746
Wall thickness compensation LW 150x 5	117367
Wall thickness compensation LW 75x 5	117370

PERI Rental Criteria

LIWA



Wall thickness compensation	Description	Instruction	Billing Condition	Type
	28.70.19 Plate bent or broken			
	28.70.20 Concrete surface bent ■ ≤ 3 mm			
	■ Or > 3 mm			
	28.70.21 Cover plate bent			
	■ Without damages of the welding ■ Or with damage of the welding	 	 	 
	28.70.22 Profile bent ■ > 5 mm	 		

PERI Rental Criteria

LIWA



Wedge Clamp LIWA (117573)	No.	Name	Article number
---------------------------	-----	------	----------------

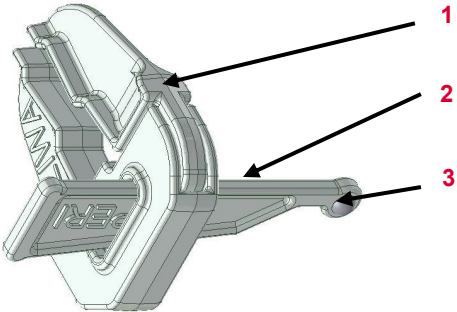

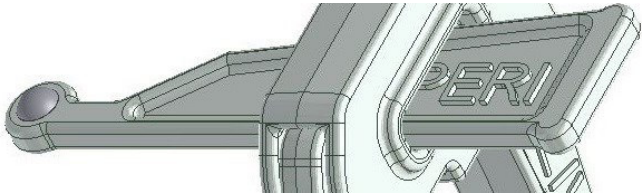

1	Basic body	
2	Wedge DOMINO	100703
3	rivet	107521

Damage	Description	Instruction	Billing Condition	Type
--------	-------------	-------------	-------------------	------



28.70.23 Wedge bent |missing

 100703 (wedge)
 107521 (rivet)

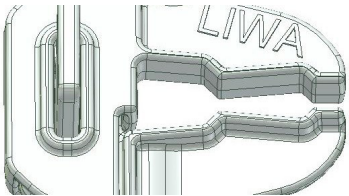

28.70.24 Basic body bent

■ Connection not possible



PERI Rental Criteria

LIWA



Wedge Clamp Compensation LIWA (117677)	No.	Name	Article number
--	-----	------	----------------

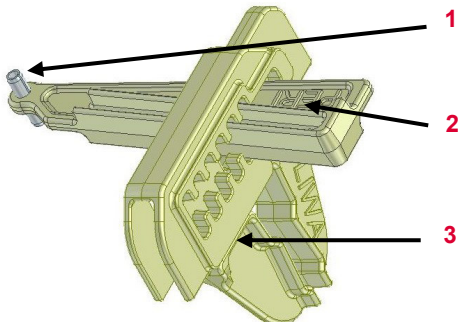

1	Sleeve	123786
2	LIWA Wedge	117672
3	Base body	

Schaden	Description	Instruction	Billing Condition	Type
---------	-------------	-------------	-------------------	------

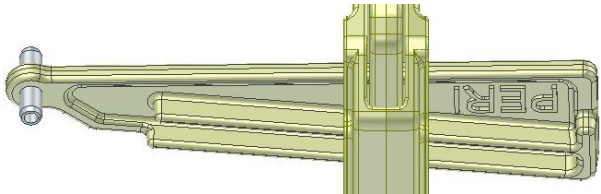

28.70.25 Wedge bent | missing

 LIWA Keil (117672)
Spannstift (123786)

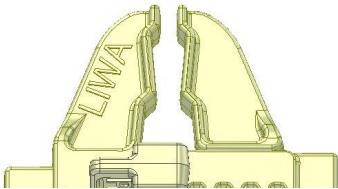

28.70.26 Base body bent

■ Connection not possible



PERI Rental Criteria

LIWA



Waler	No.	Name	Article number
-------	-----	------	----------------

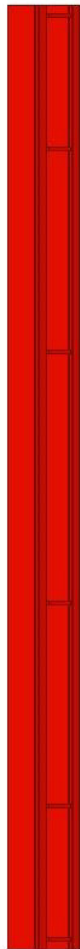
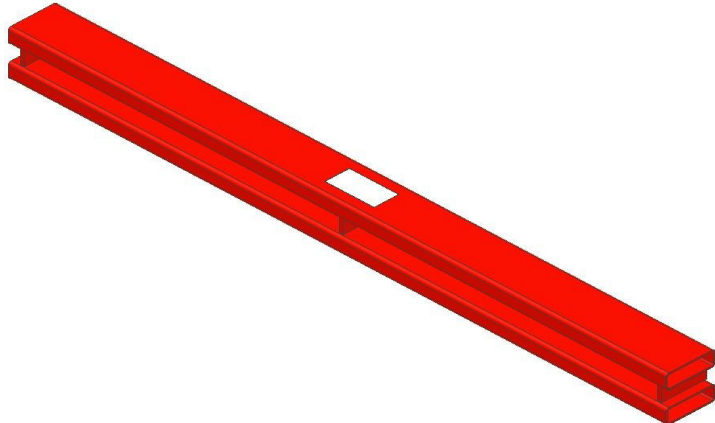
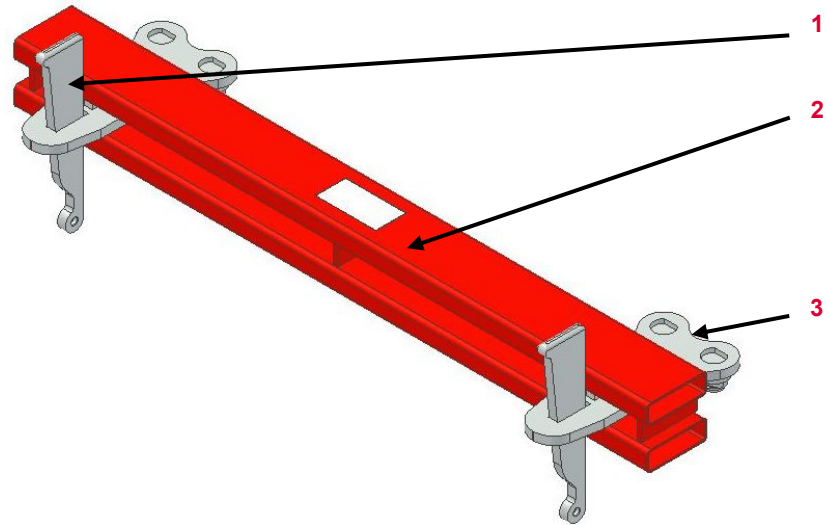











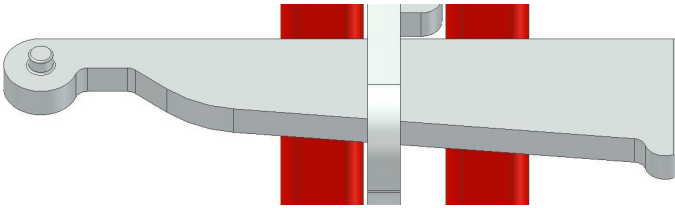



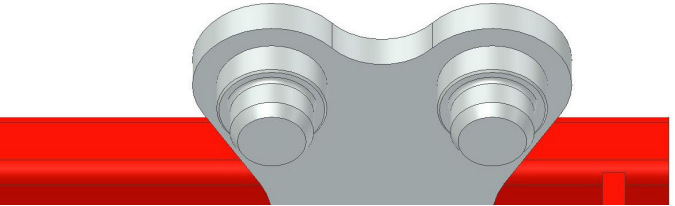



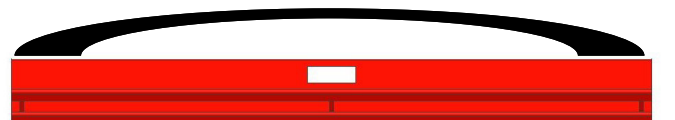

1	Wedge DAR	723898
2	Waler	
3	Double hook	117315

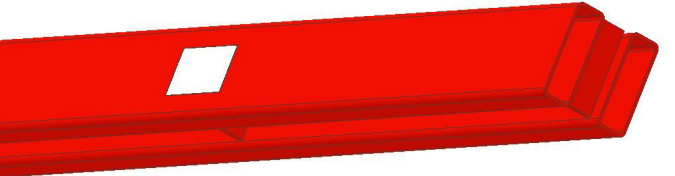
Valid for	Article number
Compensation waler LWR 60	117320
Waler LWR 80	118380
Waler 170	125473

PERI Rental Criteria

LIWA



Waler	Description	Instruction	Billing Condition	Type
	<p>28.70.27 Wedge bent missing</p> <ul style="list-style-type: none"> ■ Function not available 			
	<p>28.70.Double hook bent missing</p> <ul style="list-style-type: none"> ■ Function not available 			
	<p>28.70.29 Waler bent</p> <ul style="list-style-type: none"> ■ > 6 mm 	 		
	<p>28.70.30 Dents in profile</p> <ul style="list-style-type: none"> ■ If possible ■ Or if not and d > 3 mm 	  	 	 

PERI Rental Criteria

LIWA



Brace connector LIWA (117169)	No.	Name	Article number
-------------------------------	-----	------	----------------

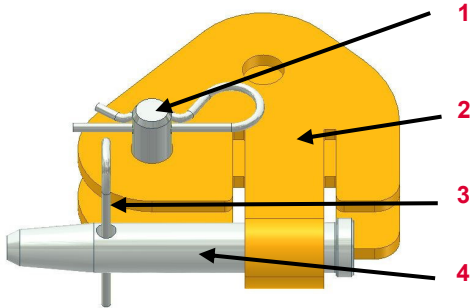

1	Bolt	027170
2	Base body	
3	Cotter pin	018060
4	Bolt	105400

Damage	Description	Instruction	Billing Condition	Type
--------	-------------	-------------	-------------------	------

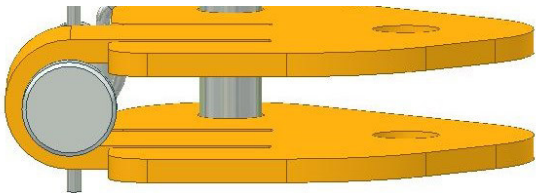

28.70.31 Base body bent

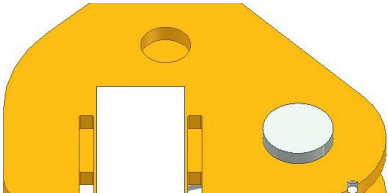

28.70.32 Crack in base body



PERI Rental Criteria

LIWA



Brace Connector—2; LIWA (125329)	No.	Name	Article number
----------------------------------	-----	------	----------------

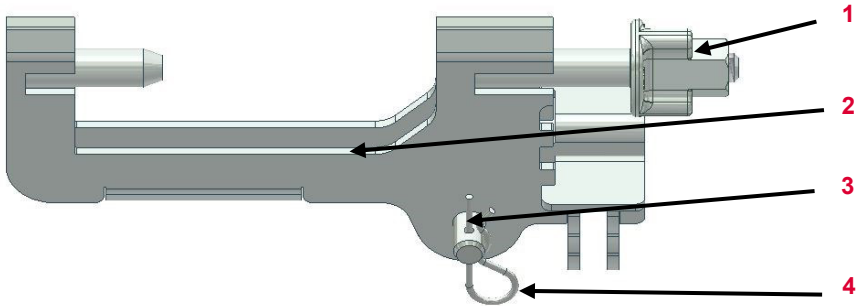

1	Cam nut	030130
2	Base body	
3	Bolt	027170
4	Cotter pin	018060

Damage	Description	Instruction	Billing Condition	Type
--------	-------------	-------------	-------------------	------

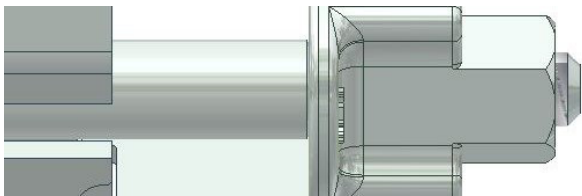

28.70.33 Cam nut broken | missing



Nockenmutter (030130)

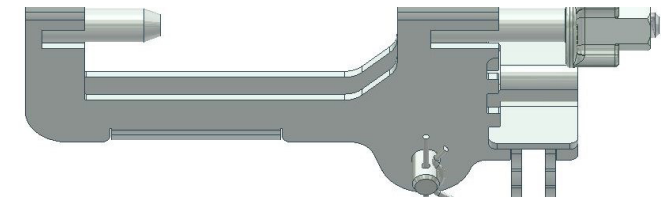

28.70.34 Base body bent



PERI Rental Criteria

LIWA



Scaffold Bracket LW 80 (117354)	No.	Name	Article number
---------------------------------	-----	------	----------------











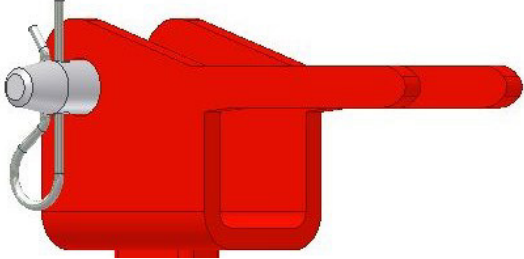







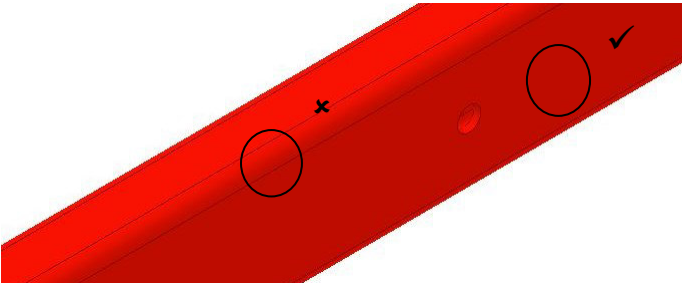



1	Bolt	105822
2	Cotter pin	018060
3	Connection	

PERI Rental Criteria

LIWA



Scaffold Bracket	Description	Instruction	Billing Condition	Type
	28.70.35 Connection bent			
	<ul style="list-style-type: none"> ■ If possible 			
	<ul style="list-style-type: none"> ■ Or if not 	 		
	28.70.36 Dent in tube			
	<ul style="list-style-type: none"> ■ Edge not affected 			
	<ul style="list-style-type: none"> ■ Or edge affected 	 		
	28.70.37 Crack in welding	 		

PERI Rental Criteria

LIWA



Guardrail Post LIWA (125100)	No.	Name	Article number
------------------------------	-----	------	----------------

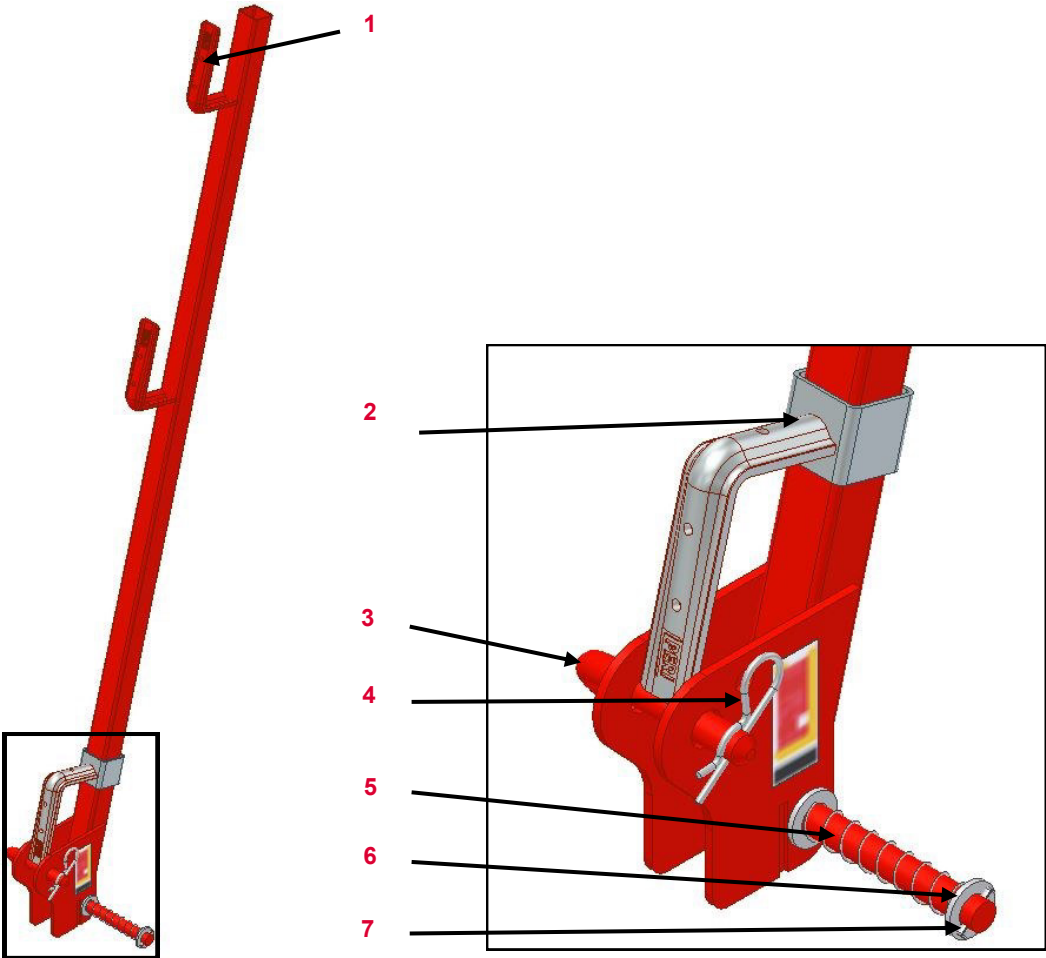









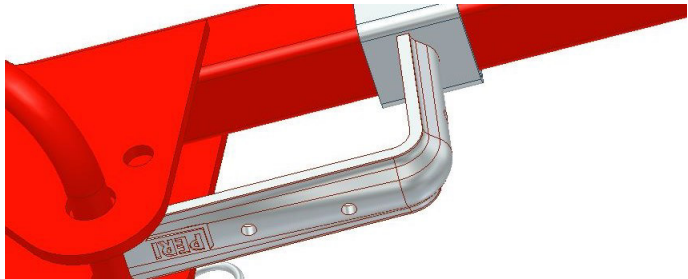

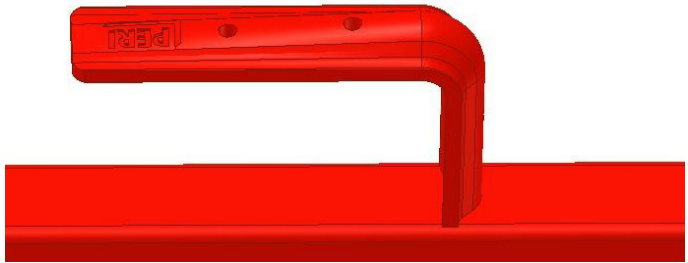

1	L Angle	115543
2	Slider	115673
3	Plug	721814
4	Spring	721816
5	Washer	711074
6	Sleeve	710912

PERI Rental Criteria

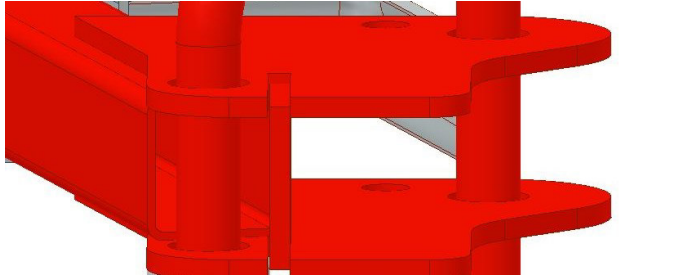
LIWA



















Guardrail post	Description	Instruction	Billing Condition	Type
	<p>28.70.38 Slider bent</p>	 115673 (Slider)		
	<p>28.70.39 L- Angle broken missing</p>			
	<p>28.70.40 Connection bent</p>			

PERI Rental Criteria

Glossar Icons



Icon	Significance	Icon	Significance	Icon	Significance
	Not Ok– material is scrap		Billing necessary (customer)		Optical damage
	OK– material stays in rental park		No Billing necessary		Functional damage
	Scrap material– it's not permitted to hand out the material because of safety aspects		Shorten material		Functional damage— it's not permitted to hand out the material
	Repair according to instruction		Mark material		Static damage— it's not permitted to hand out the material
	Fix material cold—Afterwards check weld seams and bordering components		Replace damaged material		
	Repair after local economic efficiency calculation		Replace missing material		
	Clean material				