

PERI Rental Criteria

RAPID Column Formwork



Contact

PERI GmbH
Formwork Scaffolding
Engineering

P. O. Box 1264
 89264 Weißenhorn
 Phone +49 (0) 7309.950-0
 Fax +49 (0) 7309.951-0
rental-criteria@peri.de

Content	Page
Column Form	2
Concreting platform	5
Crane hook concreting platform	9-
Crane suspension RAPID	12
Brace connector RAPID	13
Ladder 180/6	14
Ladder safety	15
Ladder connection RAPID	16
Glossary	17

Change	Date Initial	Page
New Version	11/2015 fw	

PERI Rental Criteria

RAPID Column Formwork



Column Form RAPID	No.	Description	Article number
-------------------	-----	-------------	----------------

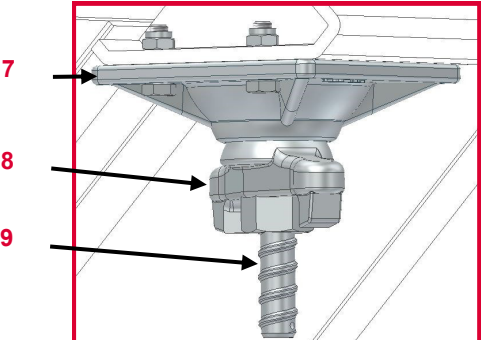
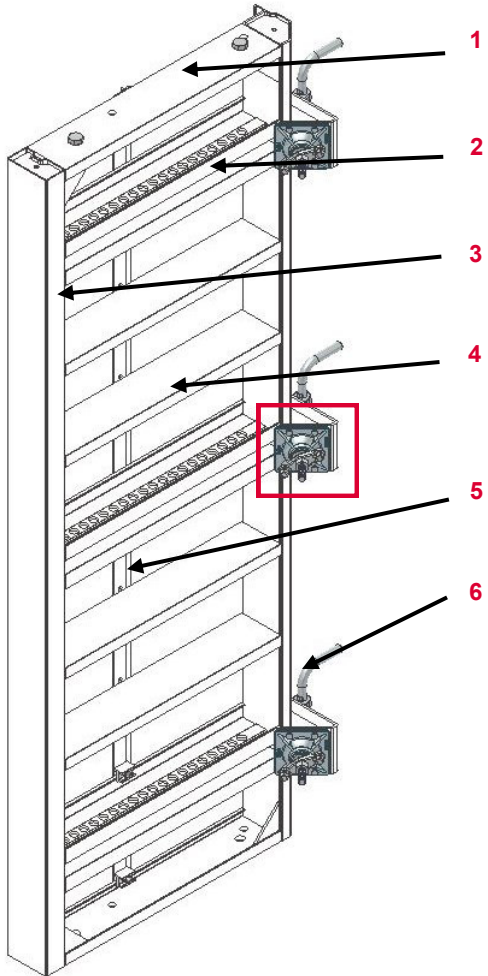

1	End brace	
2	Tension rail	
3	Rand brace	
4	Cross brace	
5	Clamping profile	
6	Locking pin	037160
7	Hinge	780360
8	Spherical nut	030440
9	Tie Yoke	037150

Valid for	Article number
Column Form RAPID 300 Alu	037250
Column Form RAPID 210 Alu	037260
Column Form RAPID 60 Alu	037270

PERI Rental Criteria

RAPID Column Formwork





















Column Form	Description	Instruction	Billing Condition	Type
	17.10.01 Clamping profile <ul style="list-style-type: none"> ■ Bent 		088244	
	<ul style="list-style-type: none"> ■ Or buckled 		Clamping profile 300 (786105) Clamping profile 210 (786104) Clamping profile 60 (786103)	088836 088835 088834
	17.10.02 Nose and brace bent <ul style="list-style-type: none"> ■ Without crack 		088244	
	<ul style="list-style-type: none"> ■ Or with crack 		088273	
	17.10.03 Hole, crack in profile <ul style="list-style-type: none"> ■ ≤ 30 mm 		088273	
	<ul style="list-style-type: none"> ■ Or > 30 mm 			

PERI Rental Criteria

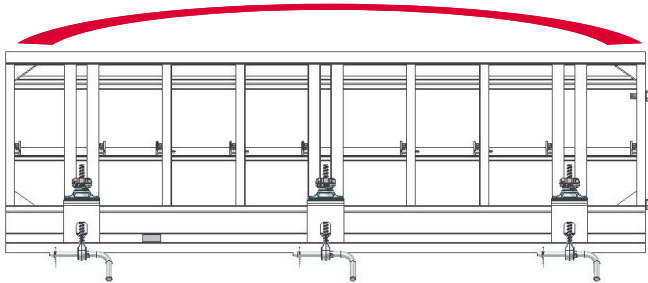
RAPID Column Formwork



Column Form	Description	Instruction	Billing Condition	Type
	17.10.04 Cross brace deformed ■ If possible		 088244	
	■ Or if not possible			
	17.10.05 Tension rail bent, broken ■ If possible		 088244	
	■ Or if not possible			
	17.10.06 Column form bent ■ > 6 mm	 		

PERI Rental Criteria

RAPID Column Formwork















Concreting platform (037400)	No.	Description	Article number
	1	Platform handrail 134	037430
	2	Platform handrail 52	037420
	3	Crane Hook	037440
	4	Telescopic tube	786108
	5	Railing post	
	6	Concreting landing	037410

PERI Rental Criteria

RAPID Column Formwork











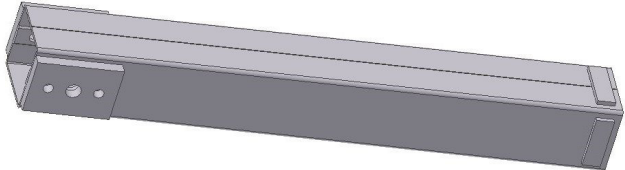

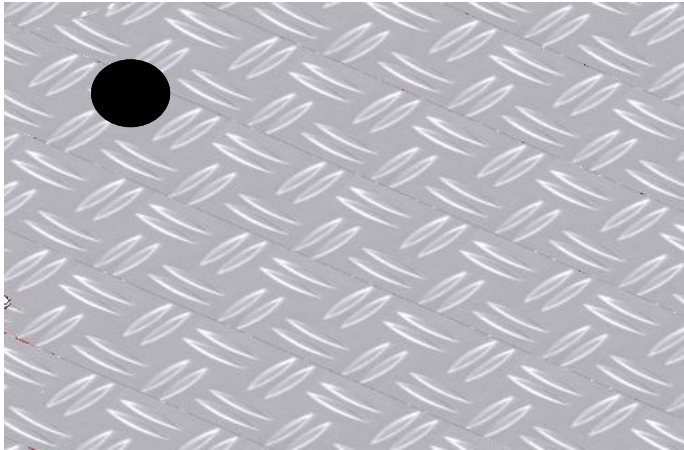

Concreting platform	Description	Instruction	Billing Condition	Type
	17.10.07 Handrail 134	<ul style="list-style-type: none"> <li data-bbox="875 571 1010 598">■ Weld torn 	 Handrail 134 (037430)  088590 	
	<ul style="list-style-type: none"> <li data-bbox="875 719 1021 746">■ Or buckled 	 Handrail 134 (037430)	 088590	
	17.10.08 Handrail 52	<ul style="list-style-type: none"> <li data-bbox="875 1062 1010 1090">■ Weld torn 	 Handrail 52 (037420)  088589 	
	<ul style="list-style-type: none"> <li data-bbox="875 1206 1021 1233">■ Or buckled 	 Handrail (037420)	 088589	

PERI Rental Criteria

RAPID Column Formwork















Concreting platform	Description	Instruction	Billing Condition	Type
	<p>17.10.09 Telescopic tube</p> <ul style="list-style-type: none"> ■ Bent 	 Telescopic tube(786108)	 088582	
	<ul style="list-style-type: none"> ■ Or holes uprooted 	 Telescopic tube (786108)		
	<p>17.10.10 Holes in surface</p> <ul style="list-style-type: none"> ■ ≤ 30 mm 			
	<ul style="list-style-type: none"> ■ > 30 mm 			

PERI Rental Criteria

RAPID Column Formwork



Damage Concreting platform	Description	Instruction	Billing Condition	Type
	17.10.11 Railing post	<ul style="list-style-type: none"> ■ Bent without crack in material or weld  	 088244 	
	<ul style="list-style-type: none"> ■ Bent with crack in material or weld 		 	
	17.10.12 Baluster	<ul style="list-style-type: none"> ■ Bent without crack in material or weld  	 088244 	
	<ul style="list-style-type: none"> ■ Bent with crack in material or weld 		 	

PERI Rental Criteria

RAPID Column Formwork



Crane Hook Concreting Platform (037440)	No.	Description	Article number
-----------------------------------------	-----	-------------	----------------

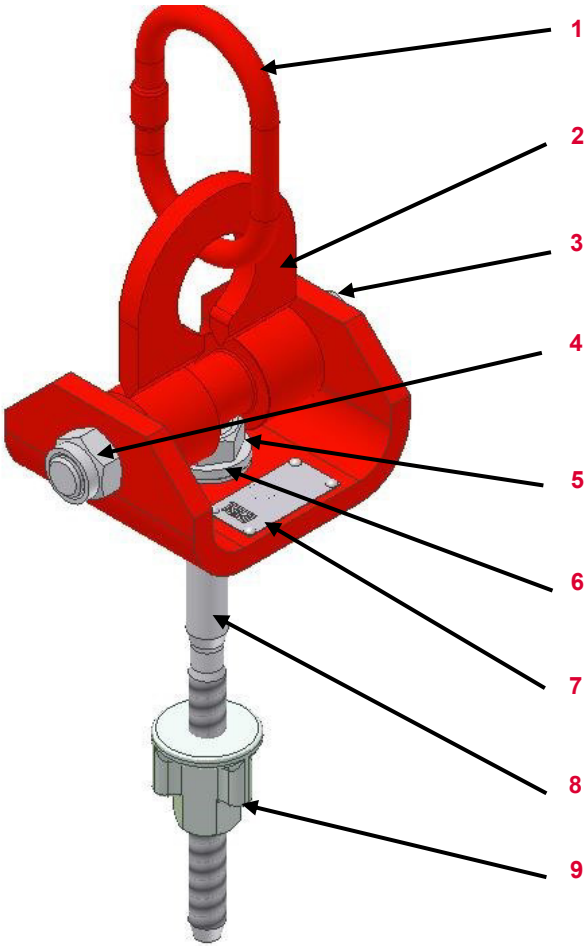











1	Crane suspension	
2	Crane eye	
3	Hex Bolt	781054
4	Hex Nut	781053
5	Washer	105513
6	Disc spring	781016
7	Type plate	710539
8	Column Tie Bolt	054230
9	Cam Nut	030130

PERI Rental Criteria

RAPID Column Formwork















Crane hook	Description	Instruction	Billing Condition	Type
	<p>17.10.13 Type plate unreadable, lost</p>	 <p>Type plate (710539) Grooved pin (767043)</p>		
	<p>17.10.14 Suspension bracket</p> <ul style="list-style-type: none"> ■ $\varnothing \leq 12,5 \text{ mm}$ 	 		
	<p>17.10.15 Crane suspension</p> <ul style="list-style-type: none"> ■ $A \leq 22,5 \text{ mm}$ 	 		

PERI Rental Criteria

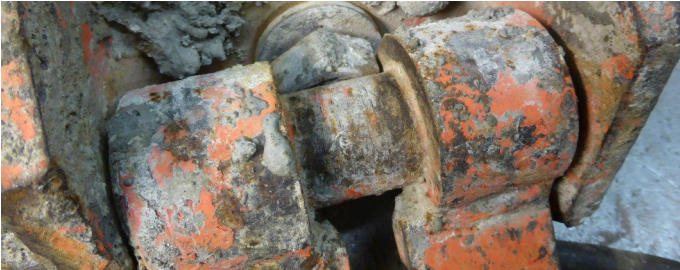
RAPID Column Formwork













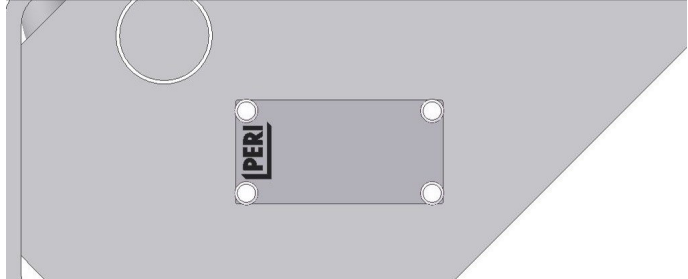

Crane hook	Description	Instruction	Billing Condition	Type
	17.10.16 Cam nut broken	 Cam nut (030130)	 088429	
	17.10.17 Column tie bolt bent, broken	 Column Tie Bolt (054230)		
	17.10.18 Crane suspension not passable	 Lubricate afterwards		

PERI Rental Criteria

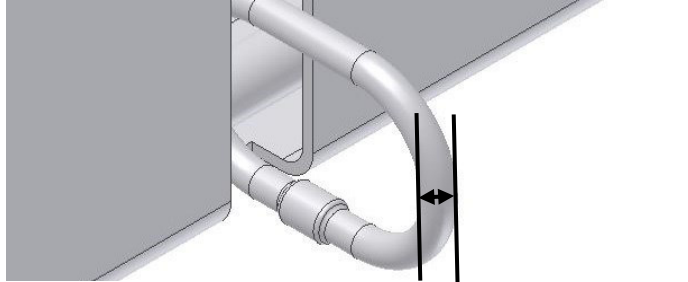
RAPID Column Formwork



Crane suspension-2 (037320)	Description	Instruction	Billing Condition	Type
	<p>17.10.19 Crane suspension bent</p>		 088244	
	<p>17.10.20 Type plate unreadable, lost</p>	 Type plate (710538) Rivet (710217)		
	<p>17.10.21 Crane suspension</p> <p>■ $\varnothing \leq 12,5 \text{ mm}$</p>	 		

PERI Rental Criteria

RAPID Column Formwork



Brace connctor 3 RAPID (037190)	No.	Description	Article number
---------------------------------	-----	-------------	----------------

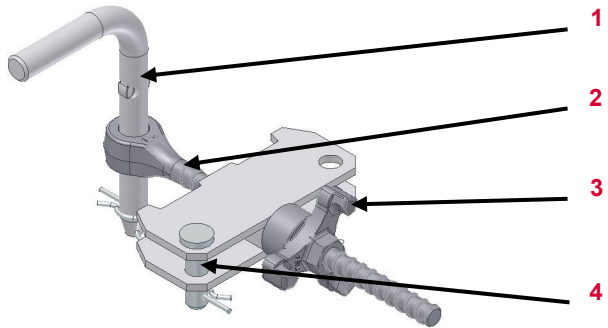

1	Locking pin	037160
2	Tie Yoke	037150
3	Three wingnut	030190
4	Pin	027170

Damage	Description	Instruction	Billing Condition	Type
--------	-------------	-------------	-------------------	------

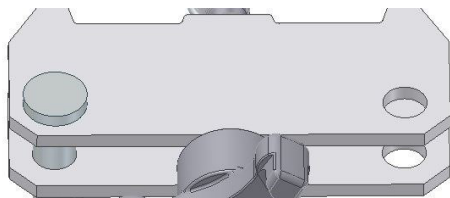

17.10.22 Clamping part bent



088244

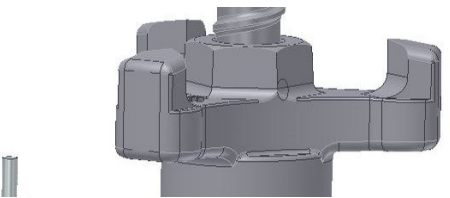

17.10.23 Three wingnut broken



Three wingnut (030190)



088541



PERI Rental Criteria

RAPID Column Formwork



Damage Ladder 180/6 (051410)	Description	Instruction	Billing Condition	Type
--------------------------------	-------------	-------------	-------------------	------

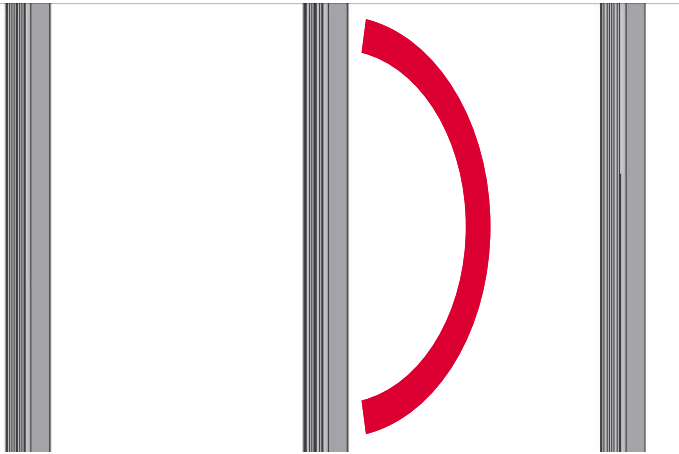

17.10.24 Tread bent

- > 3 mm

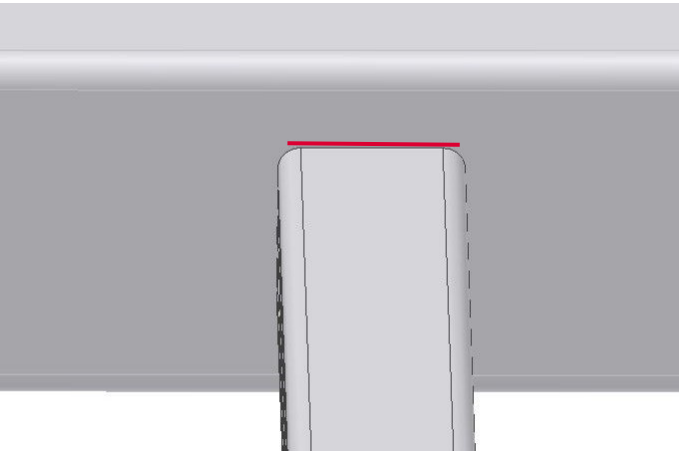

17.10.25 Weld torn

- Without deformation of material
- Or with deformation



PERI Rental Criteria

RAPID Column Formwork



Damage Ladder safety (104132; 051450)	Description	Instruction	Billing Condition	Type
-----------------------------------------	-------------	-------------	-------------------	------

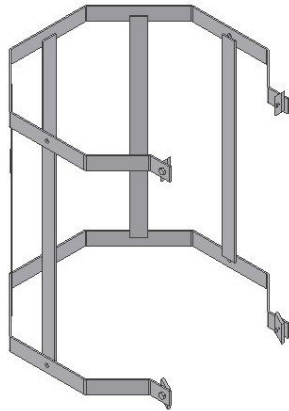

17.10.26 Bent

■ > 5 mm

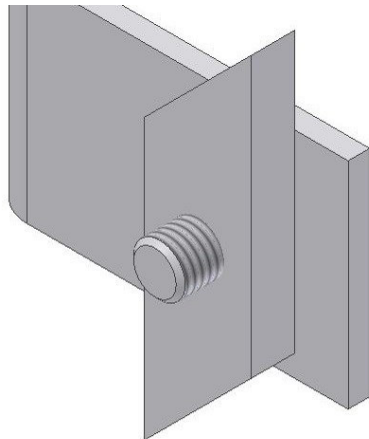

17.10.27 Clamping plate broken, lost



Clamping plate (701763)
Bolt (710266)



088295



PERI Rental Criteria

RAPID Column Formwork



Ladder Connection RAPID (103369)	No.	Description	Article number
----------------------------------	-----	-------------	----------------

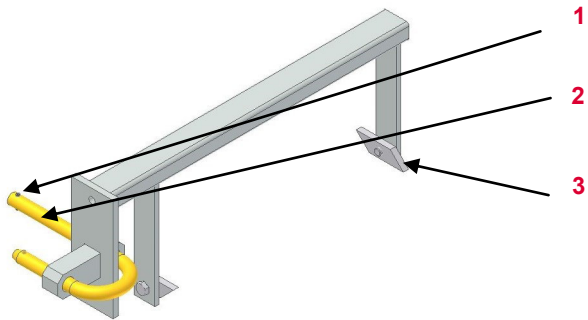

1	Sleeve	710417
2	„Sicherungsbügel“	104065
3	Clamping plate	701763

Damage	Description	Instruction	Billing Condition	Type
--------	-------------	-------------	-------------------	------



17.10.28 Clamping plate broken



Clamping plate (710763)
Bolt (710266)



088295

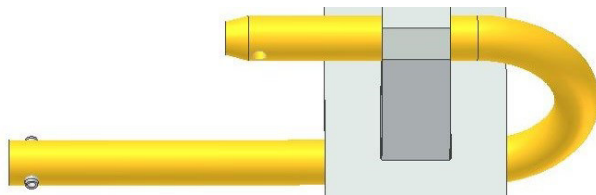

17.10.29 Sicherungsbügel bent, broken



















„Sicherungsbügel“ (104065)
Sleeve (710417)



PERI Rental Criteria

Glossar Icons



Icon	Significance	Icon	Significance	Icon	Significance
	Not OK – material ist scrap		Billing necessary (customer)		Optical damage
	OK—material stays in rental park		No Billing necessary		Functional damage
	Scrap material—it's not permitted to hand out the material because of safety aspects		Shorten the material		Functional damage— it's not permitted to hand out the material
	Repair according to Instruction		Mark the material		Static damage – it's not permitted to hand out the material
	Fix material cold		Replace damaged material		
	Repair after local economic efficiency calculation		Replace missing material		
	Clean the material				