

# PERI Rental Criteria

## Suspended Scaffold



**Contact**

**PERI GmbH**  
**Formwork Scaffolding**  
**Engineering**  
 P.O. Box 1264  
 89264 Weissenhorn, Germany  
 Phone +49 (0) 7309.950-0  
 Fax +49 (0) 7309.951-0  
 rental-criteria@peri.de

Content	Page
Folding Platform FB	2
CB Climbing System	26
ASG Bracket Platform	61
Glossary	69

Changes made	Date   Initial	Page
New Version	11/18   fw	

# PERI Rental Criteria

## Suspended Scaffold



### Folding Plattform FB 180

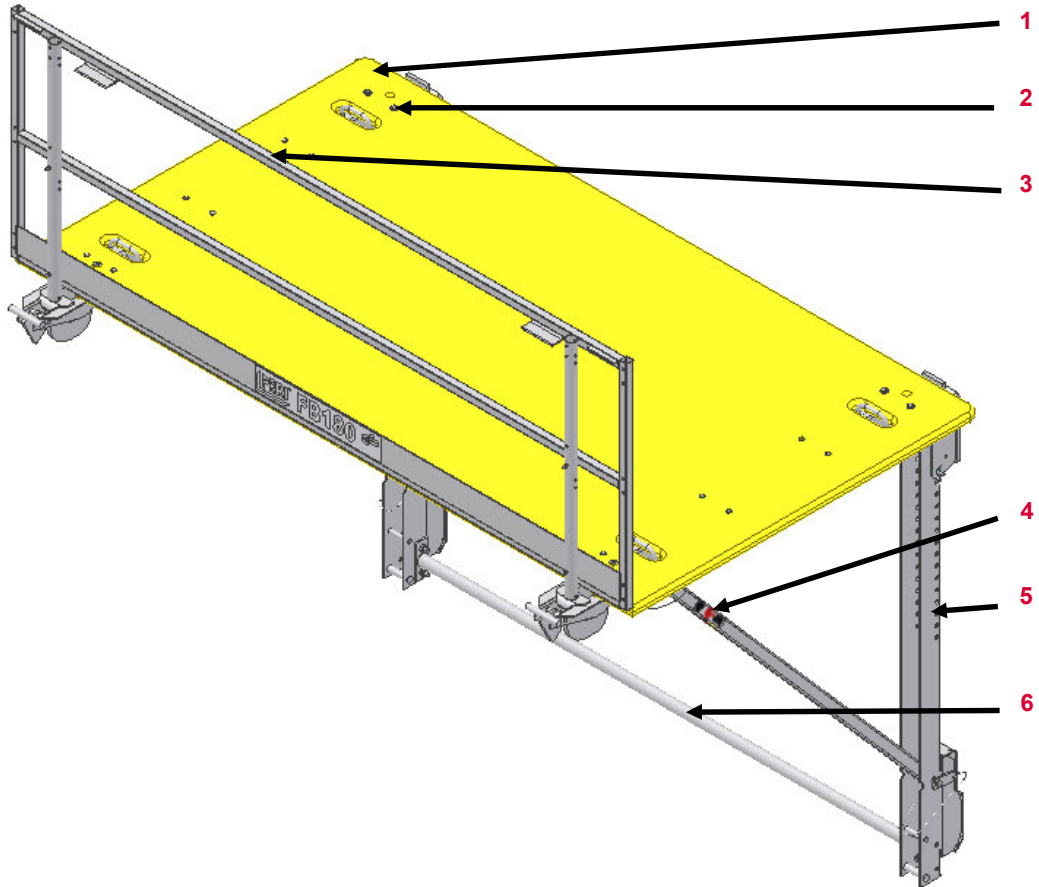



No.	Name	Article number
1	Plywood Board	
2	Bolt M8 x 60	
3	Handrail FB	
4	Bracket Brace	
5	Console	
6	Horizontal Strut	

Valid for	
Folding Plattform FB 180 - 3/300	026648
Folding Corner Plattform FEB 180 - 3/300	026649
Intermediate Plattform FBZ 240	026622
Finishing Plattform FBN-2/300	026625

# PERI Rental Criteria

## Suspended Scaffold

















Folding Platform FB	Description	Instruction	Billing	Type
	<p><b>11.01 Plywood Board corner damaged</b></p> <ul style="list-style-type: none"> <li>■ ≤ 3 cm</li> <li>■ Or &gt; 3 cm</li> </ul>	<p>Straighten, may not be a danger of stumbling</p> <p>Straighten, may not be a danger of stumbling</p>	<p>[Icon: Scaffold]</p> <p>[Icon: Scaffold]</p>	<p>[Icon: Eye]</p> <p>[Icon: Gears]</p>
	<p><b>11.02 Splintering's</b></p> <ul style="list-style-type: none"> <li>■ ≤ 3 cm</li> <li>■ Or &gt; 3 cm</li> </ul>	<p>Straighten, may not be a danger of stumbling</p> <p>Straighten, may not be a danger of stumbling</p>	<p>[Icon: Scaffold]</p> <p>[Icon: Scaffold]</p>	<p>[Icon: Eye]</p> <p>[Icon: Gears]</p>

# PERI Rental Criteria

## Suspended Scaffold



Folding Platform FB	Description	Instruction	Billing	Type
	<p><b>11.03 Plywood Board worn</b></p>			
	<p><b>11.04 Drill Hole</b></p> <ul style="list-style-type: none"> <li>■ ≤ Ø 20mm and mx 1 each m<sup>2</sup></li> <li>■ Or &lt; 20 mm</li> <li>■ Or more than one hole each m<sup>2</sup></li> </ul>	<ul style="list-style-type: none"> <li>   </li> <li>  </li> <li>  </li> </ul>	<ul style="list-style-type: none"> <li>  </li> <li>  </li> <li>  </li> </ul>	<ul style="list-style-type: none"> <li>  </li> <li>  </li> <li>  </li> </ul>

# PERI Rental Criteria

## Suspended Scaffold

















Folding Platform FB	Description	Instruction	Billing	Type
	<b>11.05 Handrail Post bent</b>	<ul style="list-style-type: none"> <li>■ ≤ 5 cm</li> </ul>		
	<ul style="list-style-type: none"> <li>■ Or &gt; 5 cm</li> </ul>			
	<b>11.06 Connection bent</b>			
	<ul style="list-style-type: none"> <li>■ Function of the jack not given</li> </ul>			

# PERI Rental Criteria

## Suspended Scaffold











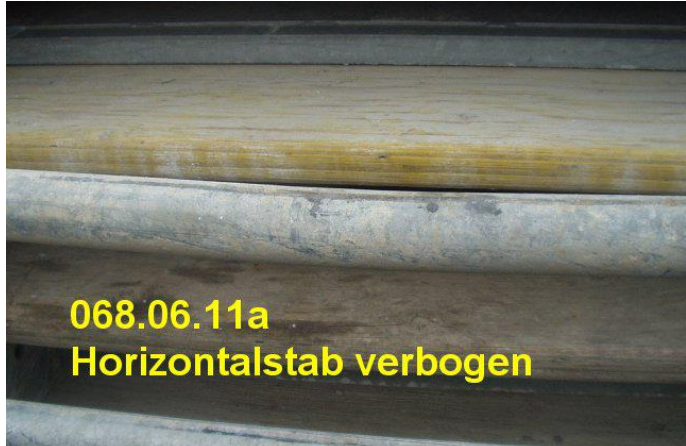

Folding Platform FB	Description	Instruction	Billing	Type
	<p><b>11.07 Handrail bent</b></p> <ul style="list-style-type: none"> <li>■ If possible</li> <li>■ Or if not possible</li> </ul>	<ul style="list-style-type: none"> <li></li> <li></li> </ul>	<ul style="list-style-type: none"> <li></li> <li></li> </ul>	<ul style="list-style-type: none"> <li></li> <li></li> </ul>
 <p>130/10/12 FFB Totalschaden</p>	<p><b>11.08 Console bent</b></p> <ul style="list-style-type: none"> <li>■ If possible</li> <li>■ Or if not possible</li> </ul>	<ul style="list-style-type: none"> <li></li> <li></li> </ul>	<ul style="list-style-type: none"> <li></li> <li></li> </ul>	<ul style="list-style-type: none"> <li></li> <li></li> </ul>

# PERI Rental Criteria

## Suspended Scaffold



Folding Platform FB	Description	Instruction	Billing	Type
	<b>11.09 Horizontal Strut bent</b>			
	<ul style="list-style-type: none"> <li>■ <math>\leq 5</math> cm and re- bending possible</li> </ul>			
	<ul style="list-style-type: none"> <li>■ Or <math>&gt; 5</math> cm</li> </ul>			
<ul style="list-style-type: none"> <li>■ Or crack in welding</li> </ul>				

# PERI Rental Criteria

## Suspended Scaffold



### Folding Bracket FB 180-3 (026652)

No. Name Article number

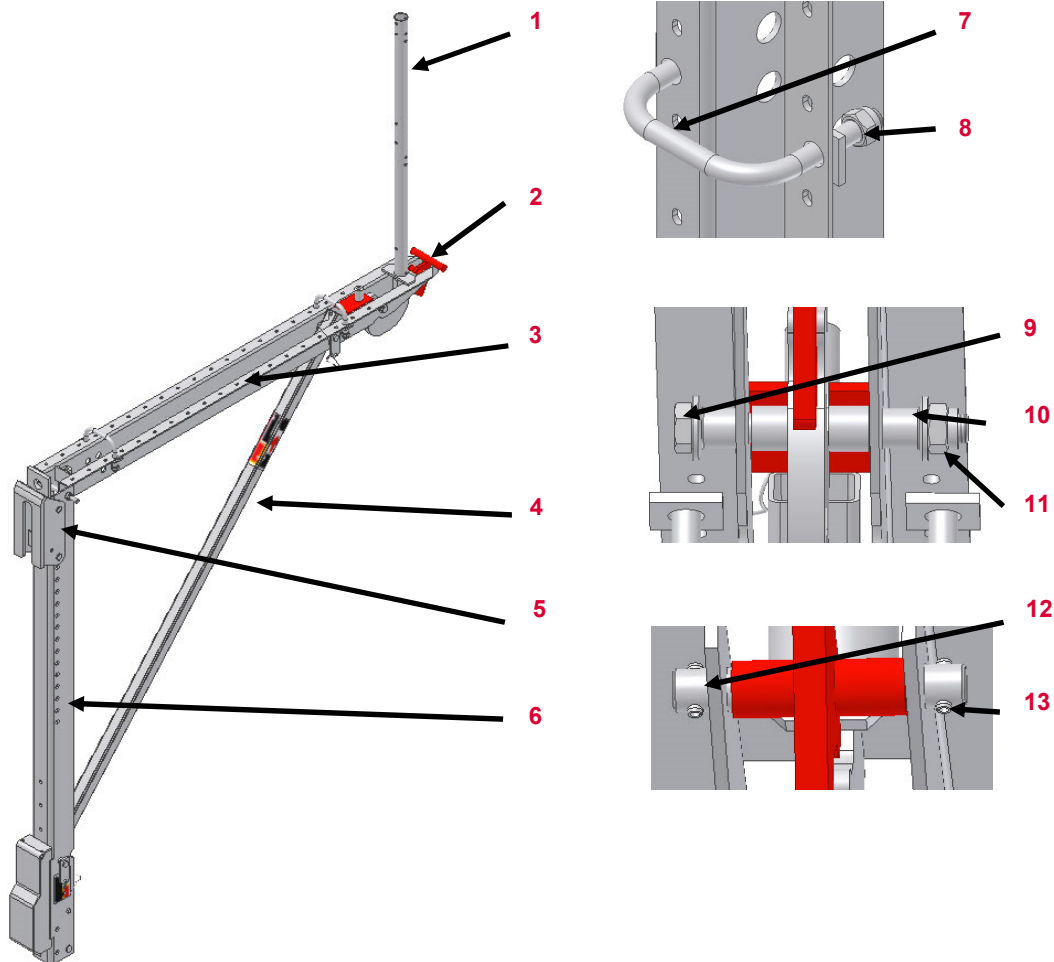













1	Guardrail Post	716268
2	Jack	716256
3	Console	
4	Bracket Brace	026651
5	Mounting Head FB	026632
6	Vertical Strut	716243
7	Crane Bracket	710499
8	Nut M 16	070890
9	Bolt M 16 x 150	710049
10	Sleeve	710496
11	Nut M 16	070890
12	Safety Axis	710498
13	Dowel Pin	780801

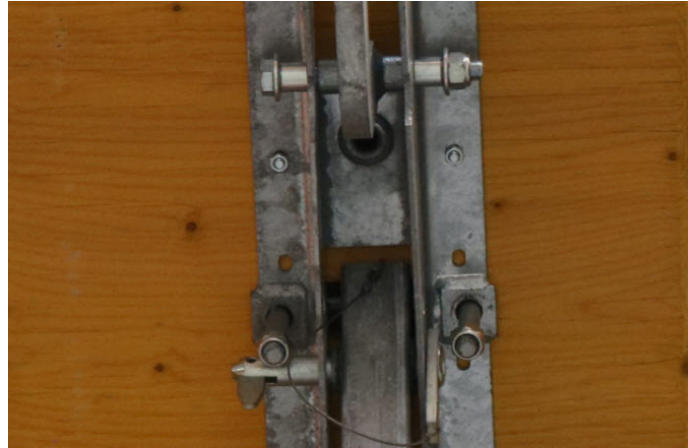

# PERI Rental Criteria

## Suspended Scaffold



Folding Bracket FB 180-3	Description	Instruction	Billing	Type
 <p>130/10/12 FFB Totalschaden</p>	<p><b>11.10 Console bent</b></p> <ul style="list-style-type: none"> <li>■ If possible</li> <li>■ Or if not possible</li> </ul>	<ul style="list-style-type: none"> <li></li> <li></li> </ul>	<ul style="list-style-type: none"> <li></li> <li></li> </ul>	<ul style="list-style-type: none"> <li></li> <li></li> </ul>
	<p><b>11.11 Bolt   Nut   Pins</b></p> <ul style="list-style-type: none"> <li>■ Missing</li> <li>■ Or damaged due to force</li> </ul>	<ul style="list-style-type: none"> <li></li> <li></li> </ul>	<ul style="list-style-type: none"> <li></li> <li></li> </ul>	<ul style="list-style-type: none"> <li></li> <li></li> </ul>

# PERI Rental Criteria

## Suspended Scaffold



### Finishing Plattform FBN-2 (026631)

No. Name Article number

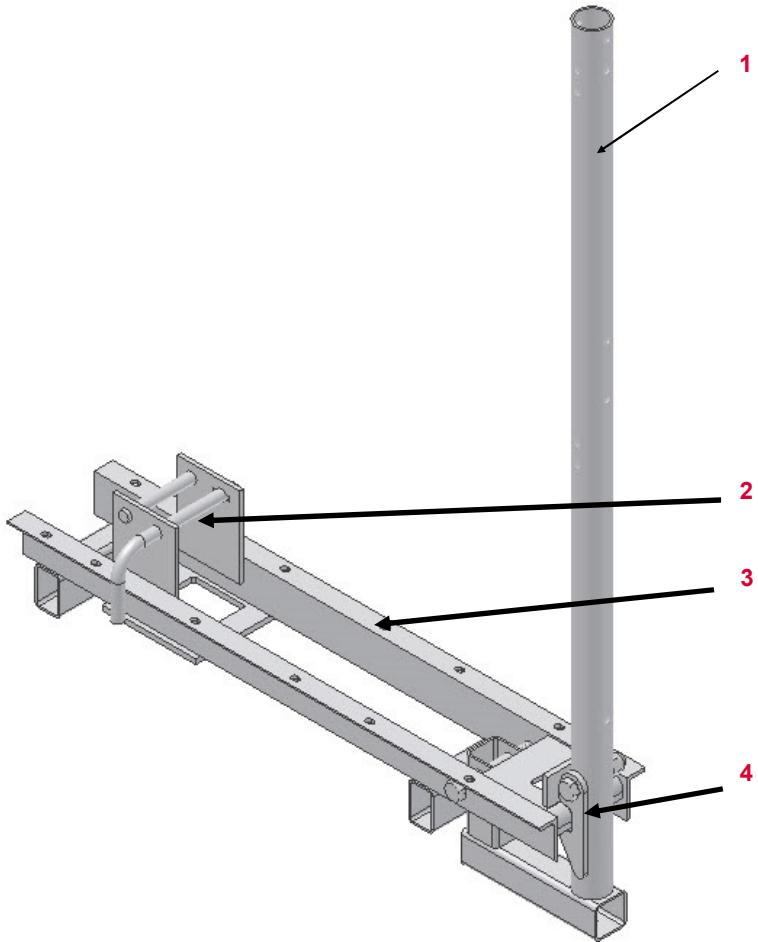

1	Guardrail Post	722157
2	Guardrail Support	722167
3	Horizontal Bracket	722166
4	Latch	722150

# PERI Rental Criteria

## Suspended Scaffold



Finishing Platform FBN-2	Description	Instruction	Billing	Type
--------------------------	-------------	-------------	---------	------



**11.12 Guardrail Post**

- Missing
- Or damaged due to force

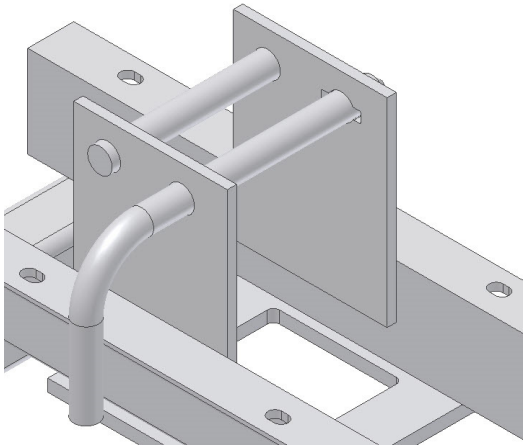

**11.13 Pin**

- Missing
- Or damaged due to force



722167 (Pin)  
780801 (Dowel pin)











722167 (Pin)  
780801 (Dowel pin)



# PERI Rental Criteria

## Suspended Scaffold



Finishing Platform FBN-2	Description	Instruction	Billing	Type
	<p><b>11.14 Function of Latch not given</b></p> <ul style="list-style-type: none"> <li>■ Damaged due to force</li> <li>■ Or function disturbed (latch don't run sluggishly)</li> </ul>			
	<p><b>11.15 Bent</b></p> <ul style="list-style-type: none"> <li>■ If possible</li> <li>■ Or if not possible</li> </ul>	 	 	 

# PERI Rental Criteria

## Suspended Scaffold



Support Extension FB-2 (026623; 026624)	No.	Name	Article number
---	-----	------	----------------

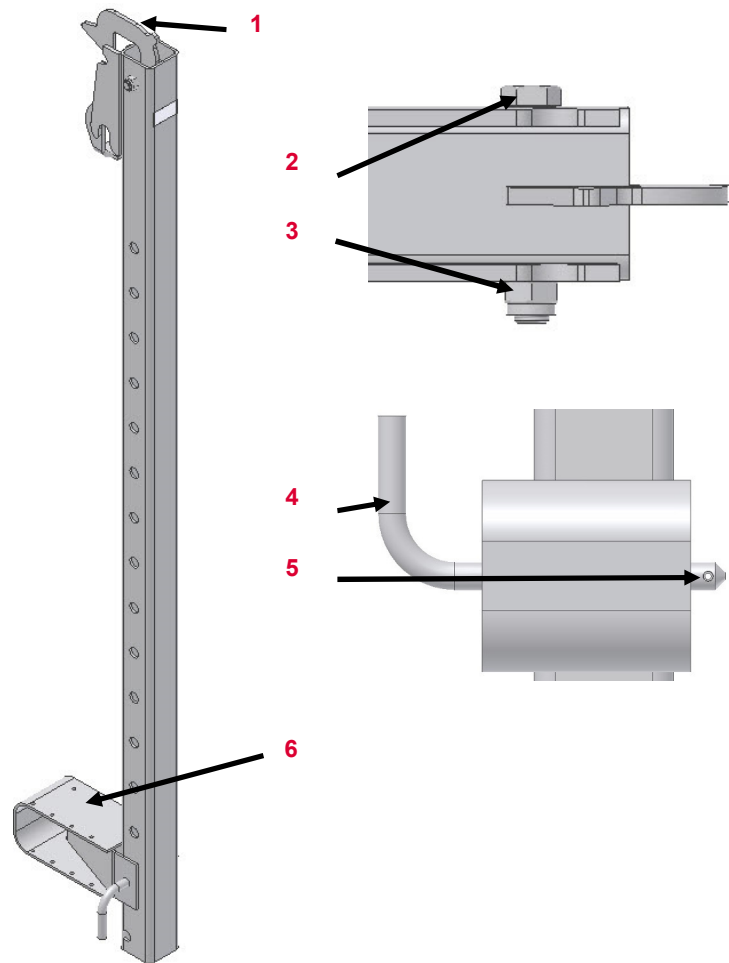















1	Latch	722178
2	Bolt M 16	710219
3	Nut M 16	070890
4	Pin 16 x 140	722167
5	Dowel Pin	780801
6	Supporting Bar	722182

# PERI Rental Criteria

## Suspended Scaffold











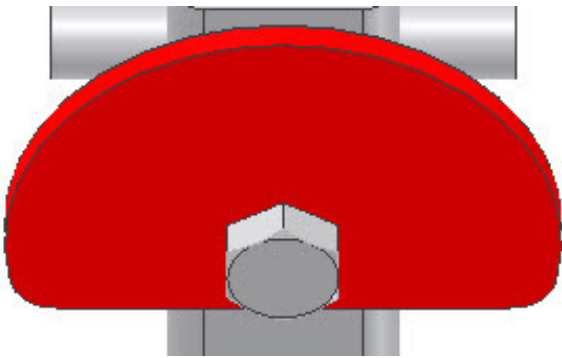

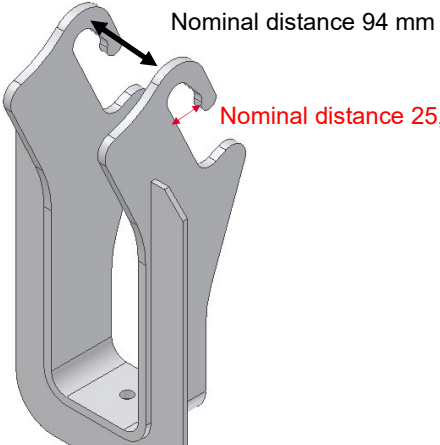

Support Extension FB-2	Description	Instruction	Billing	Type
	<b>11.16 Bolt   Nut   Pin</b>			
	<ul style="list-style-type: none"> <li>■ Missing</li> </ul>			
	<ul style="list-style-type: none"> <li>■ Or damaged due to force</li> </ul>			
	<b>11.17 Supporting Bar</b>			
	<ul style="list-style-type: none"> <li>■ Missing</li> </ul>			
	<ul style="list-style-type: none"> <li>■ Or damaged due to force</li> </ul>			

# PERI Rental Criteria

## Suspended Scaffold



Compression Strut FB-2 (026627)	Description	Instruction	Billing	Type
	<p><b>11.18 Jack   Bolt   Nut</b></p> <ul style="list-style-type: none"> <li>■ Missing</li> <li>■ Or damaged due to force</li> </ul>	<ul style="list-style-type: none"> <li>            722204 (Jack)            710222 (Bolt)            070890 (Nut)         </li> <li>            722204 (Jack)            710222 (Bolt)            070890 (Nut)         </li> </ul>	<ul style="list-style-type: none"> <li></li> <li></li> </ul>	<ul style="list-style-type: none"> <li></li> <li></li> </ul>
	<p><b>11.19 Bracket Bent</b></p> <ul style="list-style-type: none"> <li>■ If possible</li> <li>■ Or if not possible</li> </ul>	<ul style="list-style-type: none"> <li></li> <li></li> </ul>	<ul style="list-style-type: none"> <li></li> <li></li> </ul>	<ul style="list-style-type: none"> <li></li> <li></li> </ul>

# PERI Rental Criteria

## Suspended Scaffold



Corner Frame FBE (026626)	No.	Name	Article number
---------------------------	-----	------	----------------

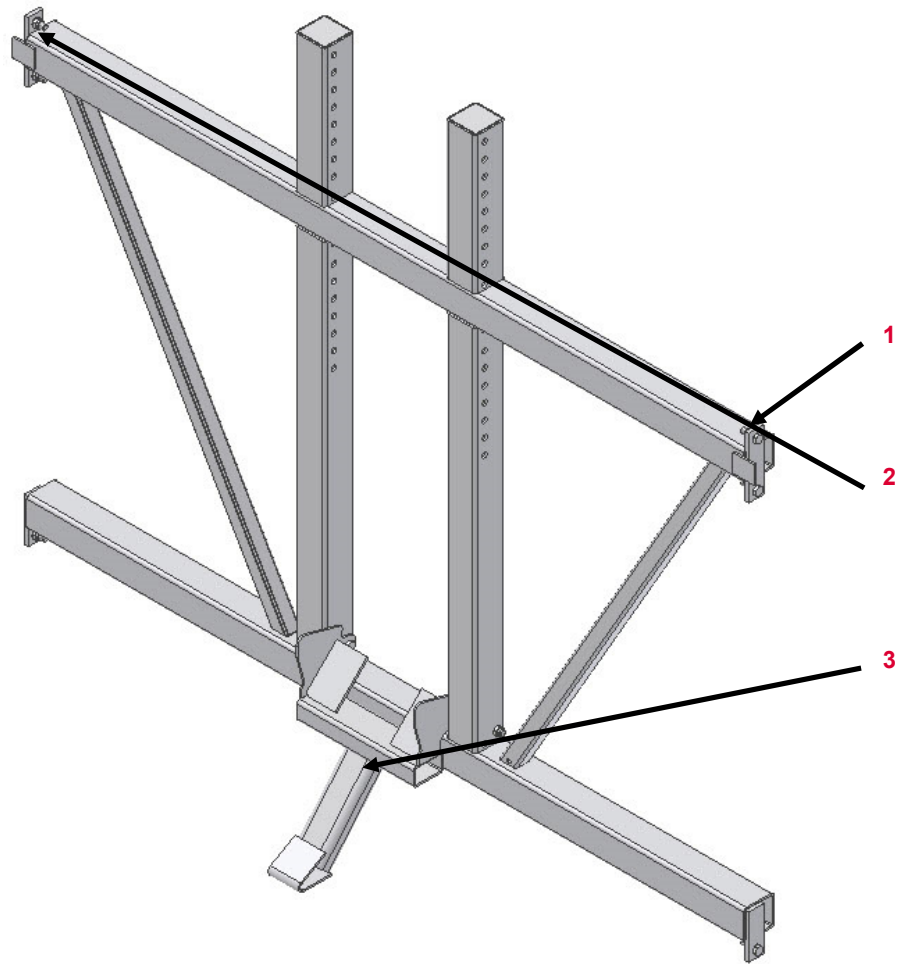

1	Bolt M16 x 45	710225
2	Nut M 16	070890
3	Corner Support	720794
4	Bolt M 16 x 130	710232

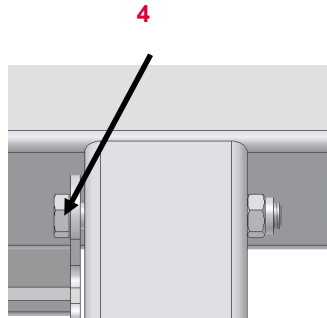













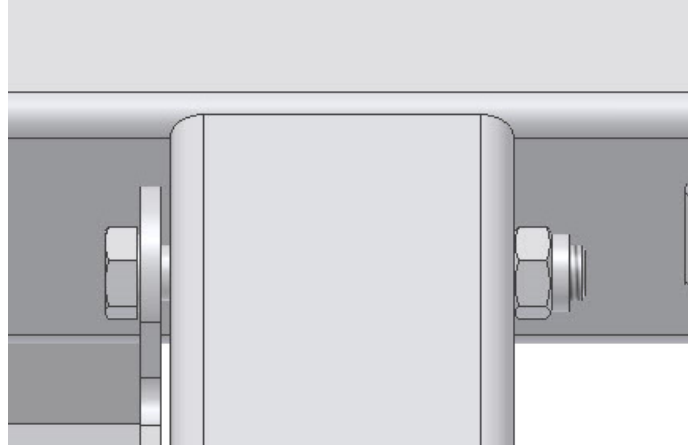

# PERI Rental Criteria

## Suspended Scaffold



















Corner Frame	Description	Instruction	Billing	Type
	<b>11.20 Corner Support</b>			
	<ul style="list-style-type: none"> <li>■ Missing</li> </ul>			
	<ul style="list-style-type: none"> <li>■ Or bent</li> </ul>			
	<b>11.21 Bolts   Nuts</b>			
	<ul style="list-style-type: none"> <li>■ Missing</li> </ul>			
	<ul style="list-style-type: none"> <li>■ Or damaged due to force</li> </ul>			

# PERI Rental Criteria

## Suspended Scaffold













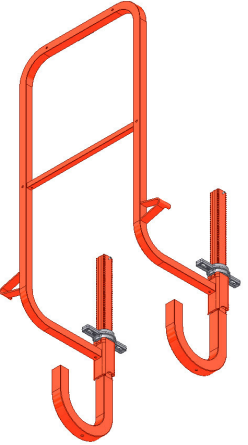

Guardrail Post FBP (026628)	Description	Instruction	Billing	Type
	<b>11.22 Sliding Piece</b>			
	<ul style="list-style-type: none"> <li>■ Missing</li> </ul>	 715185 (Sliding piece) 710287 (Dowel Pin)		
	<ul style="list-style-type: none"> <li>■ Or damaged due to force</li> </ul>	 715185 (Sliding piece) 710287 (Dowel Pin)		
	<b>11.23 Tie rod bent</b>			
	<ul style="list-style-type: none"> <li>■ If possible</li> </ul>			
	<ul style="list-style-type: none"> <li>■ Or if not possible</li> </ul>			
	<ul style="list-style-type: none"> <li>■ Or crack in material</li> </ul>			

# PERI Rental Criteria

## Suspended Scaffold













End Guardrail Frame 55 (065066)	Description	Instruction	Billing	Type
	<b>11.24 Wingnut</b>			
	<ul style="list-style-type: none"> <li>■ Missing</li> </ul>	 065047 (Wingnut)		
	<ul style="list-style-type: none"> <li>■ Or broken</li> </ul>	 065047 (Wingnut)		
	<b>11.25 Bent</b>			
	<ul style="list-style-type: none"> <li>■ If possible</li> </ul>			
	<ul style="list-style-type: none"> <li>■ Or if not possible</li> </ul>			

# PERI Rental Criteria

## Suspended Scaffold











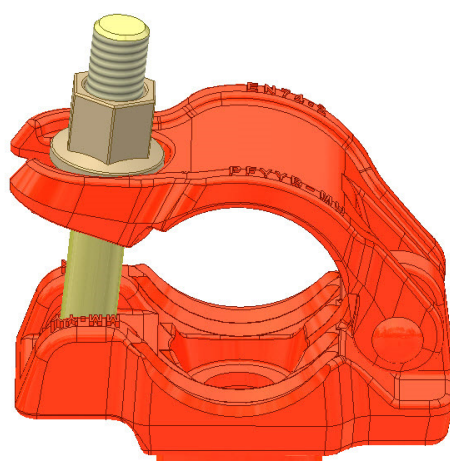





Guardrail Post Intermediate (051630)	Description	Instruction	Billing	Type
	<p><b>11.26 Plaids bent</b></p> <ul style="list-style-type: none"> <li>■ If possible</li> <li>■ Or if not possible</li> </ul>	<p>    </p>	<p>    </p>	<p>    </p>
	<p><b>11.27 Tube Bent or buckled</b></p>	<p>  </p>	<p>  </p>	<p>  </p>

# PERI Rental Criteria

## Suspended Scaffold







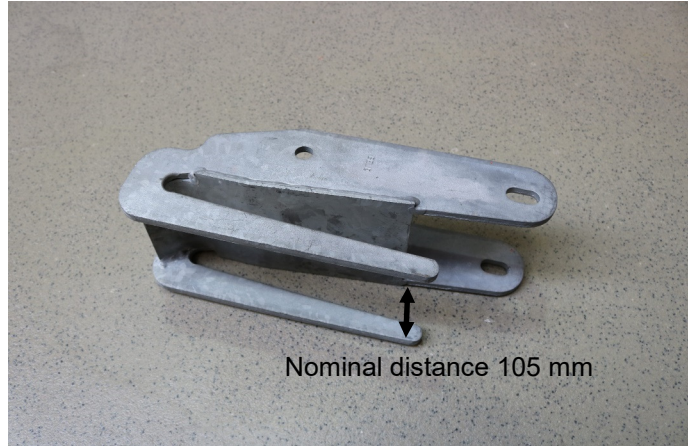

Guardrail Extension FB (026635)	Description	Instruction	Billing	Type
	<p><b>11.28 Coupler</b></p>			
	<ul style="list-style-type: none"> <li>■ Damaged (function not given)</li> </ul>			
	<ul style="list-style-type: none"> <li>■ Hammerhead Bolt missing</li> </ul>		<ul style="list-style-type: none"> <li>131316 (Hammer Head Bolt)</li> <li>710340 (Nut)</li> </ul> 	
	<p><b>11.29 Dowel Pin</b></p>			
	<ul style="list-style-type: none"> <li>■ Missing</li> </ul>		<ul style="list-style-type: none"> <li>770012 (Dowel Pin)</li> </ul> 	
	<ul style="list-style-type: none"> <li>■ Or damaged due to force</li> </ul>		<ul style="list-style-type: none"> <li>770012 (Dowel Pin)</li> </ul> 	

# PERI Rental Criteria

## Suspended Scaffold



Loop Mounting Head-2 FB (026645)	Description	Instruction	Billing	Type
 <p>Nominal distance 105 mm</p>	<p><b>11.30 Bent</b></p> <ul style="list-style-type: none"> <li>■ If possible</li> <li>■ Or if not possible</li> </ul>	<ul style="list-style-type: none"> <li></li> <li></li> </ul>	<ul style="list-style-type: none"> <li></li> <li></li> </ul>	<ul style="list-style-type: none"> <li></li> <li></li> </ul>

# PERI Rental Criteria

## Suspended Scaffold



Mounting Head FB (026632)	Description	Instruction	Billing	Type
	<b>11.31 Bent</b>	<ul style="list-style-type: none"> <li>■ If possible </li> </ul>		
	<ul style="list-style-type: none"> <li>■ Or if not possible</li> </ul>			
	<b>11.32 Connection holes worn</b>	<ul style="list-style-type: none"> <li>■ Original geometry given </li> </ul>		
	<ul style="list-style-type: none"> <li>■ Or if not given</li> </ul>			

# PERI Rental Criteria

## Suspended Scaffold



Ladder Safety Cage (051450   104132)	Description	Instruction	Billing	Type
--------------------------------------	-------------	-------------	---------	------

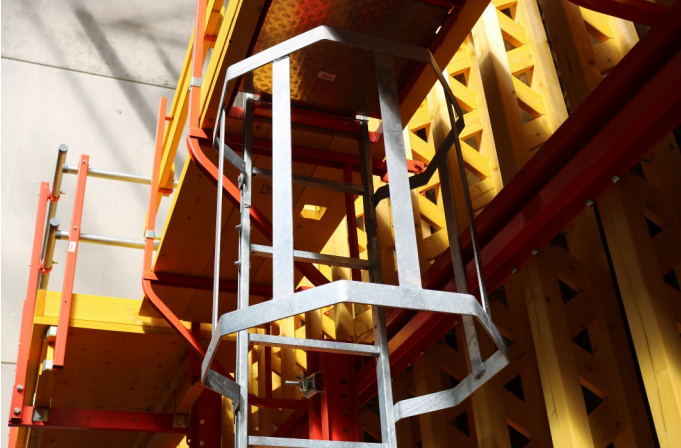

- 11.33 Bent**
- If possible
  - Or if not possible

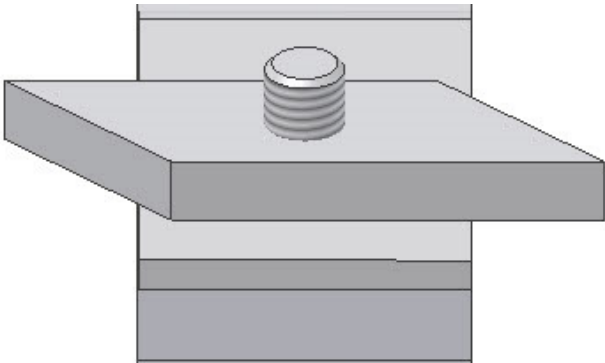

**11.34 Clamping plate missing**



707763 (Clamping Plate)  
710266 (Bolt)











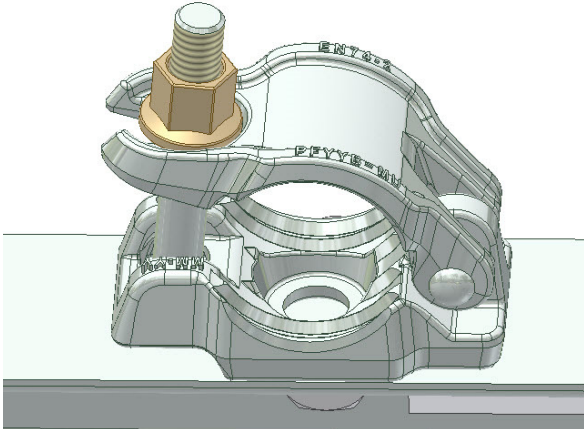

# PERI Rental Criteria

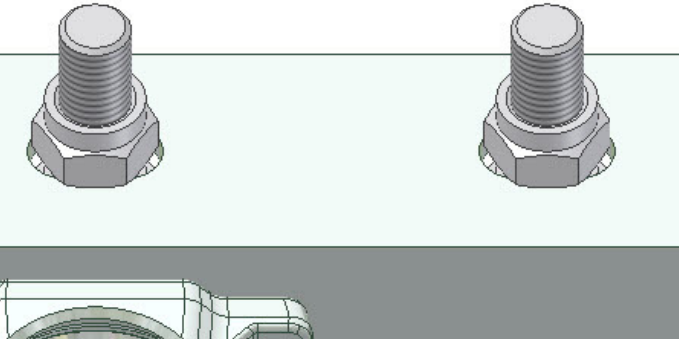
## Suspended Scaffold



Pipe Bracing Connector (026644)	Description	Instruction	Billing	Type
	<p>11.35 Coupler broken   missing</p>			
	<p>11.36 Bolts   Nuts missing</p>	 <p>710225 (Bolt) 070890 (Nut)</p>		

# PERI Rental Criteria

## Suspended Scaffold



Climbing Bracket CB (051100   051000)	No.	Name	Article number 240	Article number 160
---------------------------------------	-----	------	--------------------	--------------------

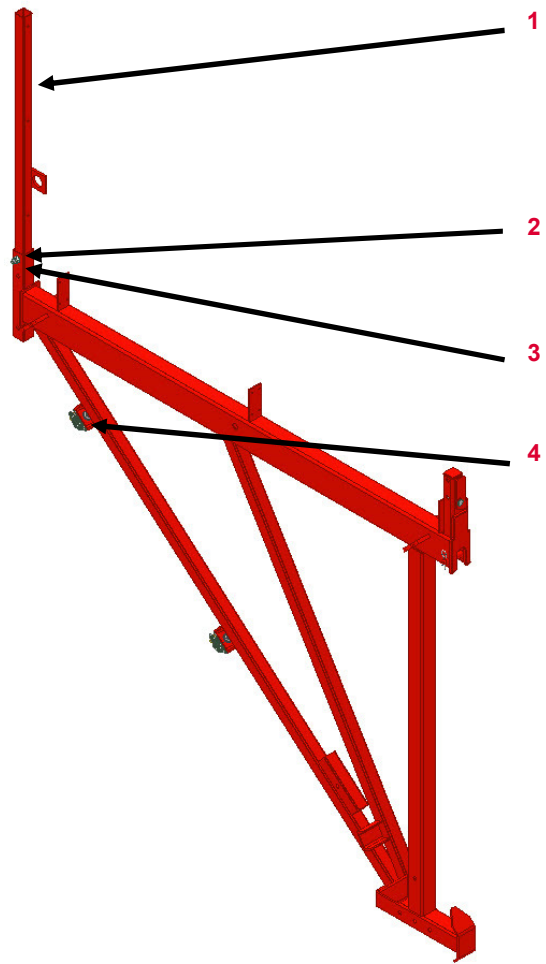



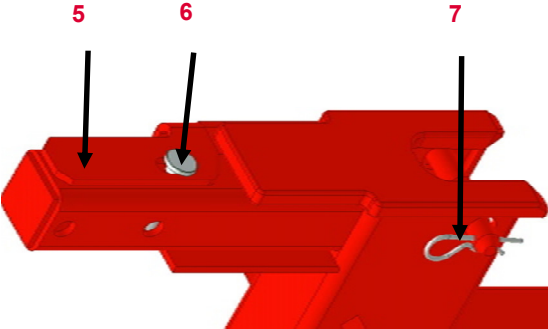















1	Guardrail Post	715977	701209
2	Bolt M 16 x 90	721729	
3	Nut M 16	070890	
4	Screw—On Coupler	017040	017040
5	Safety Lock	111147	
6	Safety Pin	111147	
7	Cotter Pin	018060	



# PERI Rental Criteria

## Suspended Scaffold











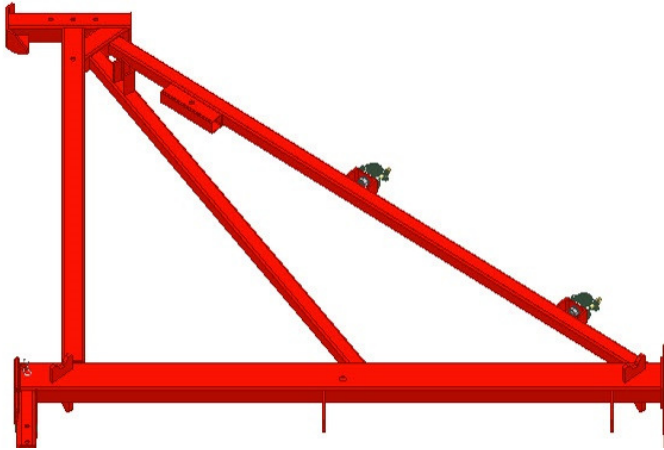





Climbing Bracket CB	Description	Instruction	Billing	Type
	<b>11.37 Guardrail Holder guide bent</b>	<ul style="list-style-type: none"> <li>■ If possible </li> </ul>		
	<ul style="list-style-type: none"> <li>■ Or if not possible</li> </ul>			
	<ul style="list-style-type: none"> <li>■ Or crack in material</li> </ul>			
	<b>11.38 Mounting Lug bent</b>	<ul style="list-style-type: none"> <li>■ If possible </li> </ul>		
	<ul style="list-style-type: none"> <li>■ Or if not possible</li> </ul>	 701222 (Mounting Lug)		
	<ul style="list-style-type: none"> <li>■ Or &gt; 45 °</li> </ul>	 701222 (Mounting Lug)		

# PERI Rental Criteria

## Suspended Scaffold













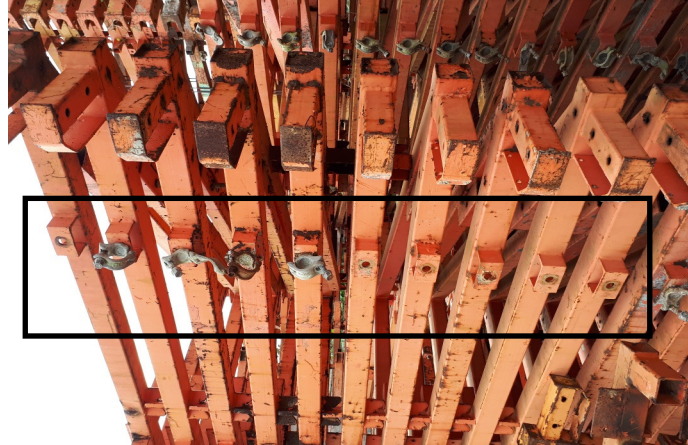

Climbing Bracket CB	Description	Instruction	Billing	Type
	<p><b>11.39 Braces bent</b></p> <ul style="list-style-type: none"> <li>■ <math>\leq 1/300</math></li> <li>■ Or <math>&gt; 1/300</math></li> </ul>	<ul style="list-style-type: none"> <li>■ </li> <li>■ </li> </ul>	<ul style="list-style-type: none"> <li>■ </li> <li>■ </li> </ul>	<ul style="list-style-type: none"> <li>■ </li> <li>■ </li> </ul>
		<p><b>11.40 Dents in Braces</b></p> <ul style="list-style-type: none"> <li>■ <math>\leq 5</math> mm deep</li> <li>■ Or <math>&gt; 5</math> mm</li> <li>■ Or edges affected</li> </ul>	<ul style="list-style-type: none"> <li>■ </li> <li>■ </li> <li>■ </li> </ul>	<ul style="list-style-type: none"> <li>■ </li> <li>■ </li> <li>■ </li> </ul>

# PERI Rental Criteria

## Suspended Scaffold



Climbing Bracket CB	Description	Instruction	Billing	Type
	<b>11.41 Safety Lock</b>			
	<ul style="list-style-type: none"> <li data-bbox="846 518 1294 614">■ Missing</li> </ul>			
	<ul style="list-style-type: none"> <li data-bbox="846 678 1294 774">■ Or bent</li> </ul>			
	<b>11.42 Screw- On Coupler</b>			
	<ul style="list-style-type: none"> <li data-bbox="846 1040 1294 1136">■ Missing</li> </ul>			
	<ul style="list-style-type: none"> <li data-bbox="846 1200 1294 1295">■ Or damaged due to force</li> </ul>			

# PERI Rental Criteria

## Suspended Scaffold



Carriage CB 240 (051020)	No.	Name	Article number
--------------------------	-----	------	----------------

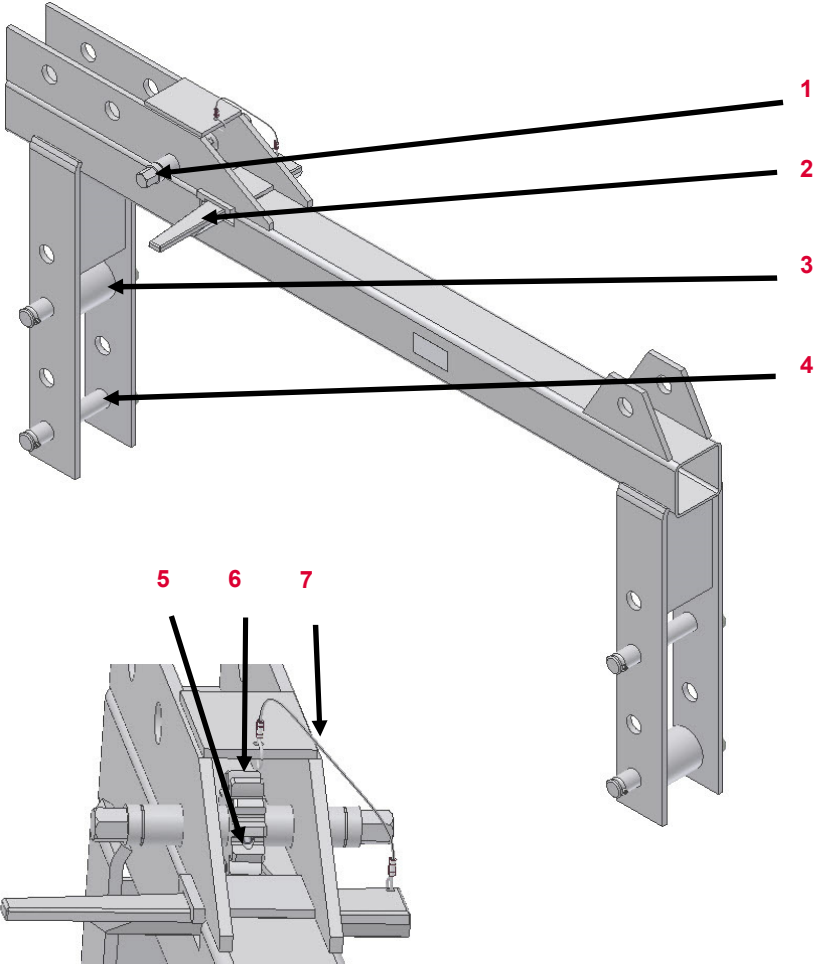













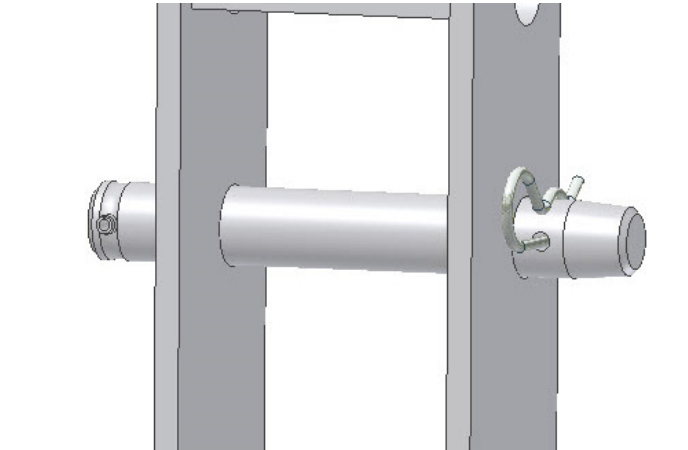

1	Axel Ø 25 x 184	710859
2	Key Wedge	710944
3	Roller	711047
4	Pin	715936
5	Sleeve	710914
6	Gear	710866
7	Robe	127303

# PERI Rental Criteria

## Suspended Scaffold











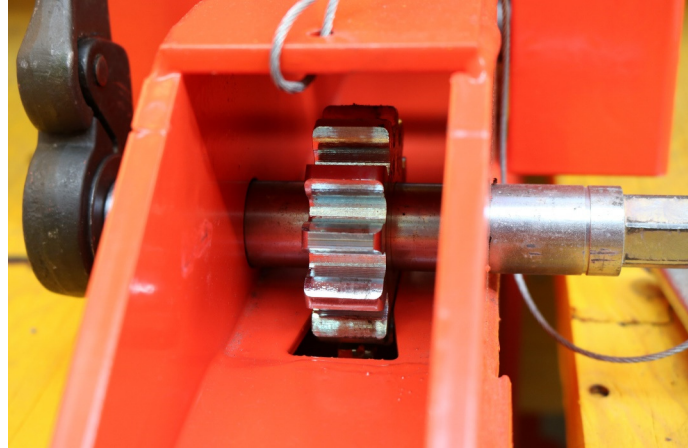





Carriage CB 240	Description	Instruction	Billing	Type
	<p><b>11.43 Plaids bent</b></p> <ul style="list-style-type: none"> <li>■ If possible</li> <li>■ Or if not possible</li> </ul>	<ul style="list-style-type: none"> <li>  </li> <li>   </li> </ul>	<ul style="list-style-type: none"> <li>  </li> <li>  </li> </ul>	<ul style="list-style-type: none"> <li>  </li> <li>  </li> </ul>
	<p><b>11.44 Pins   Cotter Pins</b></p> <ul style="list-style-type: none"> <li>■ Missing</li> <li>■ Or damaged due to force</li> </ul>	<ul style="list-style-type: none"> <li>  </li> <li>  </li> </ul>	<ul style="list-style-type: none"> <li>  </li> <li>  </li> </ul>	<ul style="list-style-type: none"> <li>  </li> <li>  </li> </ul>

# PERI Rental Criteria

## Suspended Scaffold













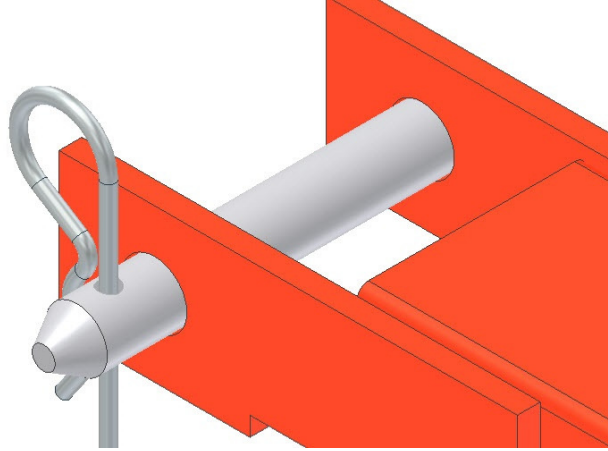

Carriage CB 240	Description	Instruction	Billing	Type
	<b>11.45 Gear</b>			
	<ul style="list-style-type: none"> <li>■ Worn</li> </ul>			
	<ul style="list-style-type: none"> <li>■ Or damaged due to force</li> </ul>			
	<b>11.46 Key wedge</b>			
	<ul style="list-style-type: none"> <li>■ Missing</li> </ul>			
	<ul style="list-style-type: none"> <li>■ Or damaged due to force</li> </ul>			

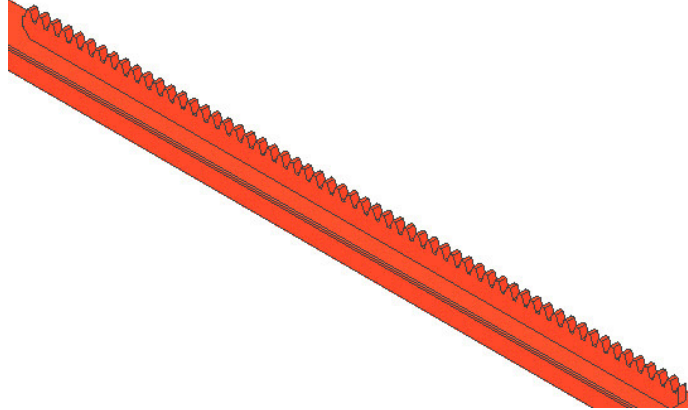

# PERI Rental Criteria

## Suspended Scaffold











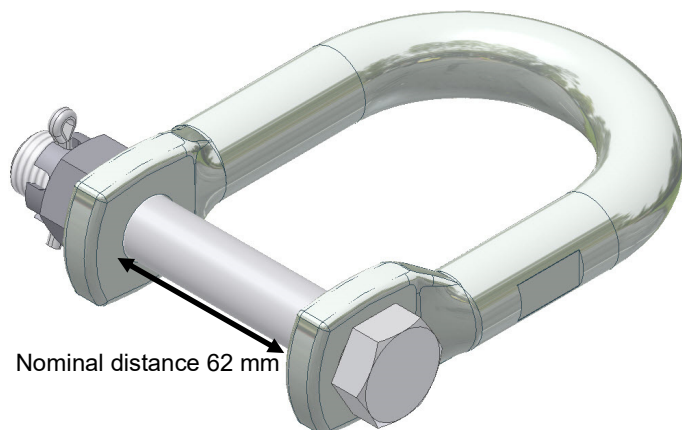







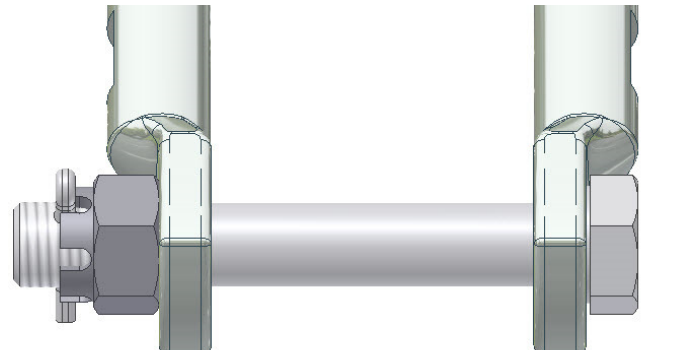

Rack CB 240 (051040)	Description	Instruction	Billing	Type
	<p><b>11.47 Pin   Cotter Pin</b></p> <ul style="list-style-type: none"> <li>Missing</li> </ul>	 <p>018050 (Pin) 018060 (Cotter Pin)</p>		
	<ul style="list-style-type: none"> <li>Or damaged due to force</li> </ul>	 <p>018050 (Pin) 018060 (Cotter Pin)</p>		
	<p><b>11.48 Rack</b></p> <ul style="list-style-type: none"> <li>Worn</li> </ul>			
	<ul style="list-style-type: none"> <li>Or damaged due to force</li> </ul>			

# PERI Rental Criteria

## Suspended Scaffold







Crane Eye CB 240-2 (127821)	Description	Instruction	Billing	Type
 <p>Nominal distance 62 mm</p>	<p><b>11.49 Crane eye bent</b></p> <ul style="list-style-type: none"> <li>Distance &gt; 64 mm (3%)</li> <li>Or distance &lt; 60 mm (3%)</li> </ul>	<ul style="list-style-type: none"> <li>   </li> <li>   </li> </ul>	<ul style="list-style-type: none"> <li>  </li> <li>  </li> </ul>	<ul style="list-style-type: none"> <li>  </li> <li>  </li> </ul>
	<p><b>11.50 Bolt   Castle Nut   Cotter Pin</b></p> <ul style="list-style-type: none"> <li>Missing</li> <li>Or damaged due to force</li> <li>Or Bolt worn, <math>\varnothing &lt; 14.5</math> mm (10%)</li> </ul>	<ul style="list-style-type: none"> <li>  <p>128335 (Bolt) 126248 (Castle Nut) 722825 (Cotter Pin)</p> </li> <li>  <p>128335 (Bolt) 126248 (Castle Nut) 722825 (Cotter Pin)</p> </li> <li>  <p>128335 (Bolt)</p> </li> </ul>	<ul style="list-style-type: none"> <li>  </li> <li>  </li> <li>  </li> </ul>	<ul style="list-style-type: none"> <li>  </li> <li>  </li> <li>  </li> </ul>

# PERI Rental Criteria

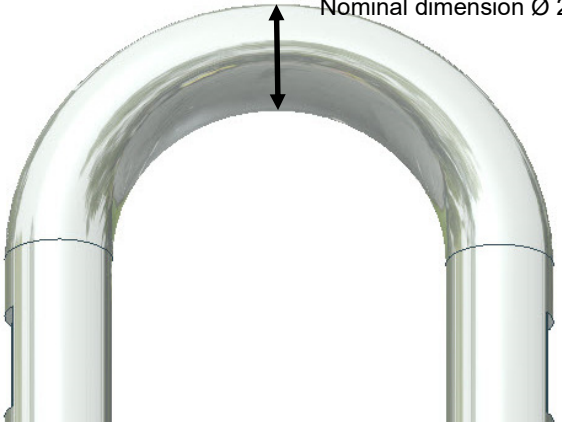
## Suspended Scaffold











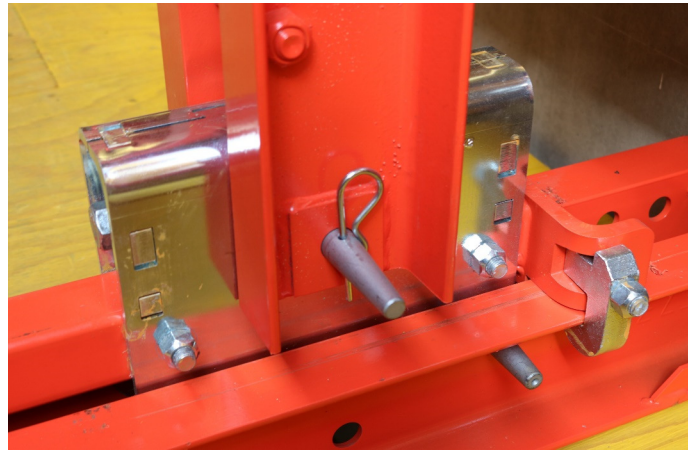

Crane Eye CB 240-2 (127821)	Description	Instruction	Billing	Type
 <p>Nominal dimension Ø 20 mm</p>	<p><b>11.51 Worn</b></p> <ul style="list-style-type: none"> <li>■ &lt; Ø 18 mm (10%)</li> </ul>	 		

# PERI Rental Criteria

## Suspended Scaffold















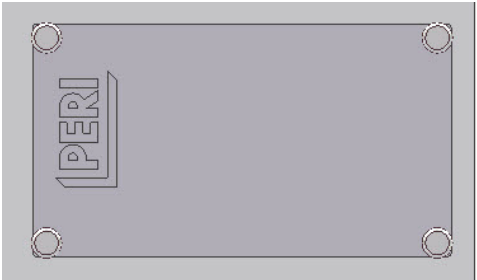

Adjusting Unit CB 160 (051130)	Description	Instruction	Billing	Type
	<p>11.52 Function not given (not moveable)</p>			
	<p>11.53 Bolts   Nuts</p> <ul style="list-style-type: none"> <li>■ Missing</li> <li>■ Or damaged due to force</li> </ul>	 <p>711084 (Bolt M20 x 150) 781053 (Nut)</p>		
				

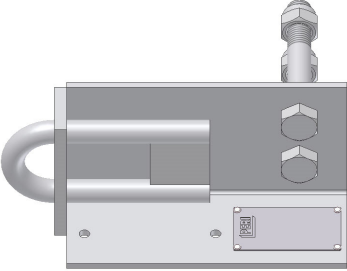
# PERI Rental Criteria

## Suspended Scaffold











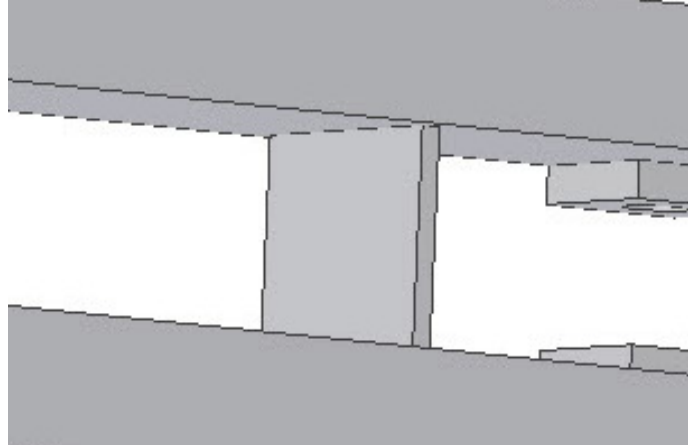

Platform Connection CB 160 (051120)	Description	Instruction	Billing	Type
	<p><b>11.54 Bolts   Nut</b></p>			
	<ul style="list-style-type: none"> <li>■ Missing</li> </ul>	<ul style="list-style-type: none"> <li> 711078 (Bolt) 781053 (Nut)</li> </ul>	<ul style="list-style-type: none"> <li></li> </ul>	<ul style="list-style-type: none"> <li></li> </ul>
	<p><b>11.55 Type plate</b></p>			
	<ul style="list-style-type: none"> <li>■ Or damaged due to force</li> </ul>	<ul style="list-style-type: none"> <li> 711078 (Bolt) 781053 (Nut)</li> </ul>	<ul style="list-style-type: none"> <li></li> </ul>	<ul style="list-style-type: none"> <li></li> </ul>
	<p><b>11.56 Bent</b></p>			
	<ul style="list-style-type: none"> <li>■ Missing</li> <li>■ Or not readable</li> </ul>	<ul style="list-style-type: none"> <li> 127295 (Type plate) 710217 (Rivet)</li> <li> 127295 (Type plate) 710217 (Rivet)</li> </ul>	<ul style="list-style-type: none"> <li></li> <li></li> </ul>	<ul style="list-style-type: none"> <li></li> <li></li> </ul>

# PERI Rental Criteria

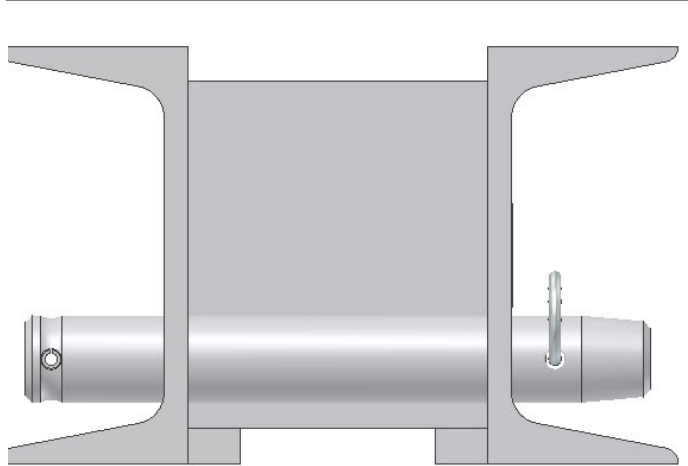
## Suspended Scaffold













Strongback CB (051060; 051150)	Description	Instruction	Billing	Type
	<b>11.57 Bar</b>			
	<ul style="list-style-type: none"> <li>■ Broken</li> </ul>	 701248 (Plaid)		
	<ul style="list-style-type: none"> <li>■ Or missing</li> </ul>			
	<b>11.58 Pin   Cotter Pin missing</b>	 715936 (Bolt) 018060 (Cotter Pin)		

# PERI Rental Criteria

## Suspended Scaffold





Strongback CB (051060; 051150)	Description	Instruction	Billing	Type
	<b>11.59 Bent</b>			
	<ul style="list-style-type: none"> <li>■ ≤ 5 mm (l/500)</li> </ul>			
	<ul style="list-style-type: none"> <li>■ Or &gt; 5 mm (l/500)</li> </ul>			
	<b>11.60 Shortened   Cut in</b>			

# PERI Rental Criteria

## Suspended Scaffold











Height Adjusting Unit CB   SCS (051030)	Description	Instruction	Billing	Type
	<p><b>11.61 Rusty</b></p> <ul style="list-style-type: none"> <li>■ Function of spindle given and Rust class &lt; D</li> <li>■ Or function not given</li> <li>■ Or rust class D</li> </ul>	<p>✓</p> <p>🗑️ 🚫</p>	<p>🚫</p> <p>🚫</p>	<p>👁️</p> <p>⚙️</p>
	<p><b>11.62 Bolt   Cotter Pin   Spindle missing</b></p>	<p>🔧</p> <p>106776 (Spindle) 715936 (Pin) 018060 (Cotter Pin)</p>	<p>🚫</p>	<p>⚙️</p>



# PERI Rental Criteria

## Suspended Scaffold















Adjustable Brace CB 164-224 (051110)	Description	Instruction	Billing	Type
	<p>11.63 Handle broken</p>	<p> 117471 (Handle)</p>	<p></p>	<p></p>
	<p>11.64 Dirty Spindle</p>	<p> Lubricate afterwards with grease (727105)</p>	<p></p>	<p></p>

# PERI Rental Criteria

## Suspended Scaffold











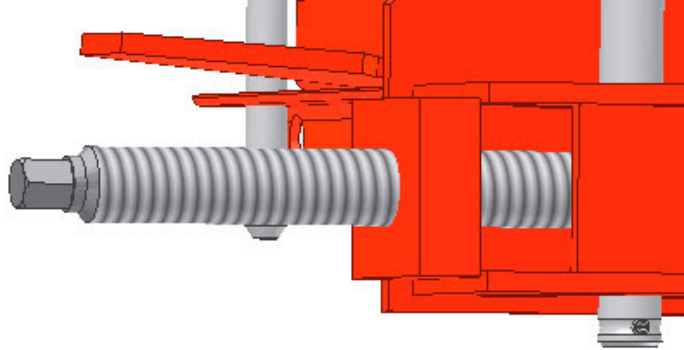

Adjustable Brace CB 164-224 (051110)	Description	Instruction	Billing	Type
	<p><b>11.65 Rusty</b></p> <ul style="list-style-type: none"> <li>■ &lt; Rust class D and function given</li> <li>■ Or rust class D</li> <li>■ Or function disturbed</li> </ul>	<p>Remove the rust and lubricate afterwards</p> <p>    </p>	<p>   </p>	<p>   </p>
	<p><b>11.66 Pin   Cotter Pin missing</b></p>	<p>            715936 (Pin)            018060 (Cotter Pin)         </p>	<p>  </p>	<p>  </p>

# PERI Rental Criteria

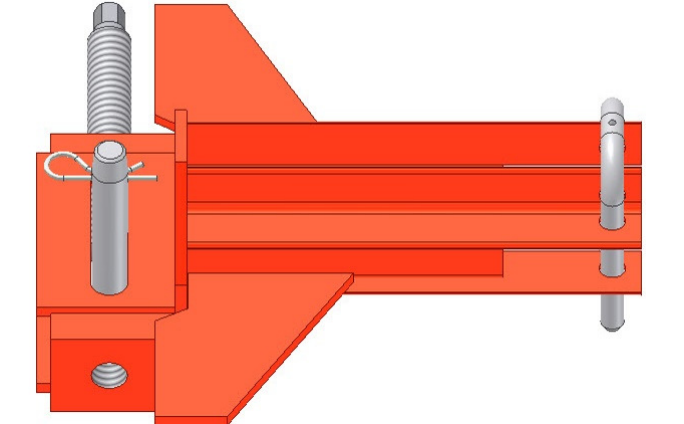
## Suspended Scaffold



Connector TRIO-CB (051090)	Description	Instruction	Billing	Type
	<b>11.67 Spindle</b>			
	<ul style="list-style-type: none"> <li>■ Missing</li> </ul>	 106776 (Spindle)		
	<ul style="list-style-type: none"> <li>■ Or damaged due to force (function not given)</li> </ul>	 106776 (Spindle)		
	<b>11.68 Pin   U- Pin   Cotter Pin missing</b>			
		 711115 (U- Pin) 715936 (Pin) 018060 (Cotter Pin)		

# PERI Rental Criteria

## Suspended Scaffold



Waler Fixation U100 - U120 (110059)	Description	Instruction	Billing	Type
-------------------------------------	-------------	-------------	---------	------

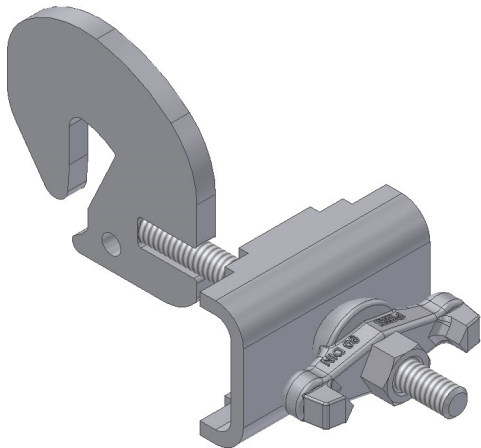

**11.69 Function not given**

- Due to wear
- Or damaged due to force



**11.70 Cross Clamp | Spherical Nut**

- Missing











110055 (Cross Clamp)  
118260 (Spherical Nut)

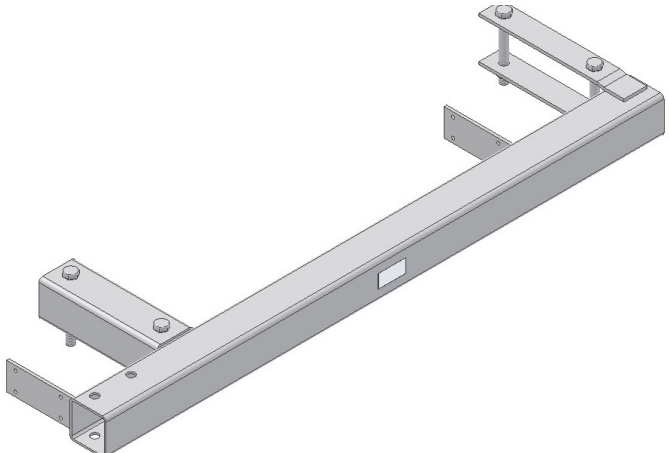

# PERI Rental Criteria

## Suspended Scaffold

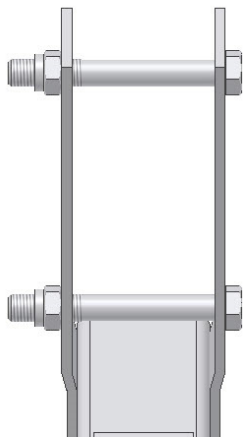

Finishing Platform Beam CB (051230)	Description	Instruction	Billing	Type
	<p><b>11.71 Plaid bent</b></p> <ul style="list-style-type: none"> <li>■ If possible</li> <li>■ Or if not possible</li> </ul>	<ul style="list-style-type: none"> <li></li> <li></li> </ul>	<ul style="list-style-type: none"> <li></li> <li></li> </ul>	<ul style="list-style-type: none"> <li></li> <li></li> </ul>
		<p><b>11.72 Bolts   Nuts missing</b></p>	<ul style="list-style-type: none"> <li> 710232 (Bolt) 070890 (Nut)</li> </ul>	<ul style="list-style-type: none"> <li></li> </ul>

# PERI Rental Criteria

## Suspended Scaffold



Plattform Post CB 225 (051200)	Description	Instruction	Billing	Type
--------------------------------	-------------	-------------	---------	------



11.73 Bent

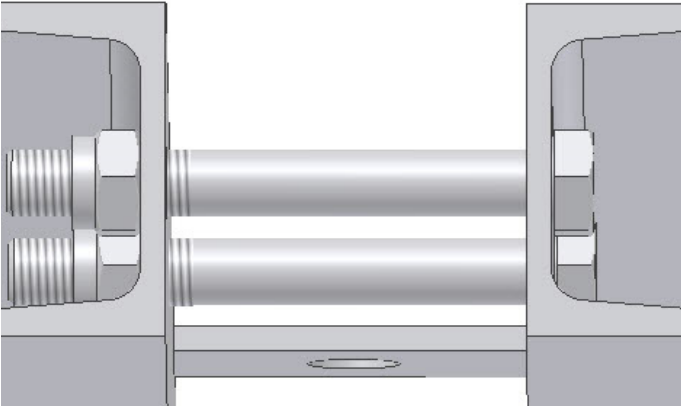

11.74 Bolts | Nuts missing











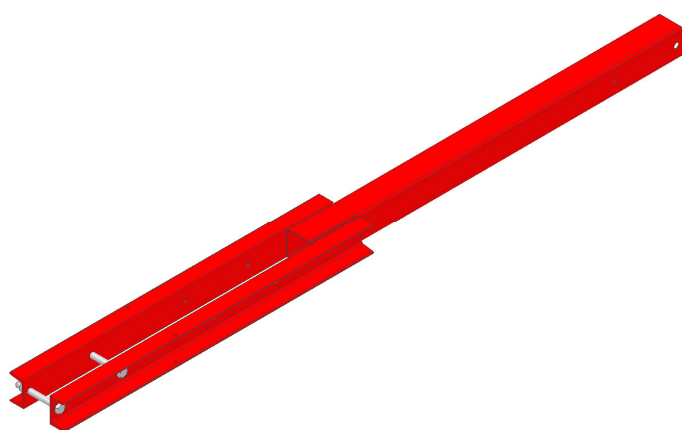

710232 (Bolt)  
070890 (Nut)

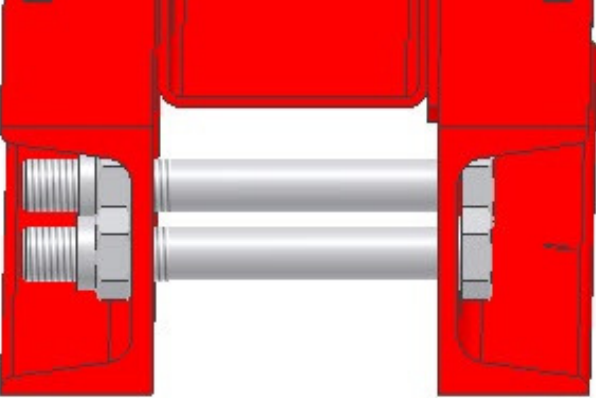

# PERI Rental Criteria

## Suspended Scaffold











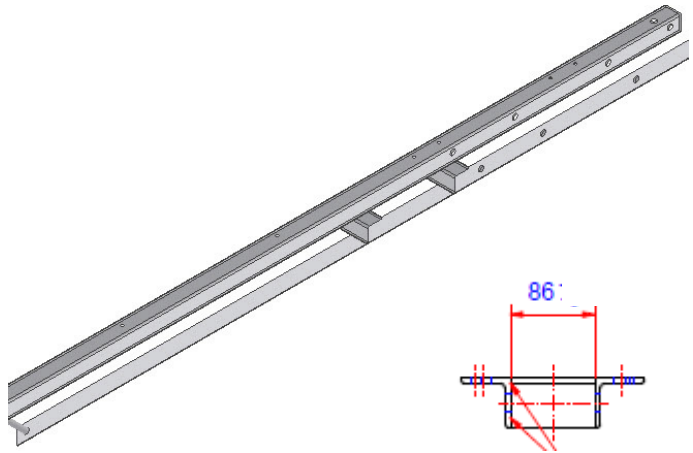

Post Extension (051050)	Description	Instruction	Billing	Type
	<p><b>11.75 Post Extension bent</b></p> <ul style="list-style-type: none"> <li>■ If possible</li> <li>■ Or if not possible</li> </ul>	<p>     </p>	<p>     </p>	<p>     </p>
	<p><b>11.76 Bolts Nuts missing</b></p>	<p>              710232 (Bolt)            070890 (Nut)         </p>	<p>  </p>	<p>  </p>

# PERI Rental Criteria

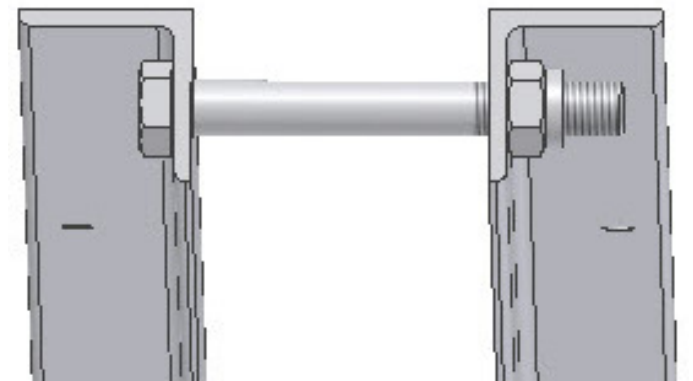
## Suspended Scaffold













Handrail Post CB 200 (051190)	Description	Instruction	Billing	Type
	<p><b>11.77 Bent</b></p> <ul style="list-style-type: none"> <li>■ If possible</li> <li>■ Or if not possible</li> </ul>	<p>If possible: </p> <p>Or if not possible: </p>	<p>If possible: </p> <p>Or if not possible: </p>	<p>If possible: </p> <p>Or if not possible: </p>
	<p><b>11.78 Bolt   Nut missing</b></p>	<p> 710232 (Bolt) 070890 (Nut)</p>	<p></p>	<p></p>

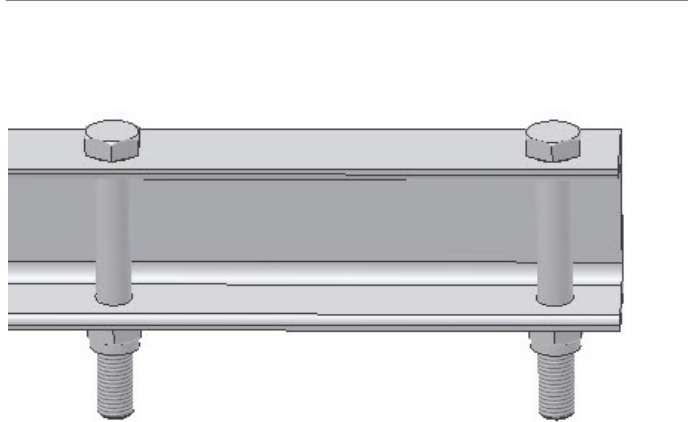

# PERI Rental Criteria

## Suspended Scaffold











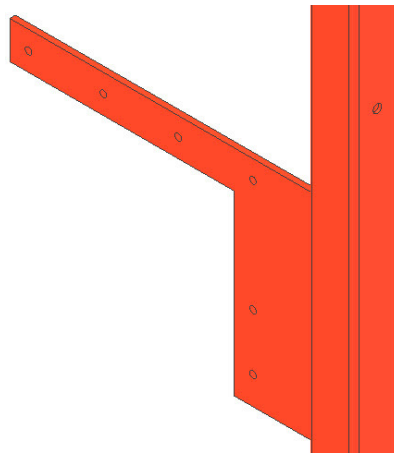

Handrail Post CB (051210   051220)	Description	Instruction	Billing	Type
	<p><b>11.79 Bent</b></p> <ul style="list-style-type: none"> <li>■ If possible</li> <li>■ Or if not possible</li> </ul>	<ul style="list-style-type: none"> <li></li> <li></li> </ul>	<ul style="list-style-type: none"> <li></li> <li></li> </ul>	<ul style="list-style-type: none"> <li></li> <li></li> </ul>
	<p><b>11.80 Bolts   Nut missing</b></p>	<ul style="list-style-type: none"> <li> 710232 (Bolt)</li> <li>070890 (Nut)</li> </ul>	<ul style="list-style-type: none"> <li></li> </ul>	<ul style="list-style-type: none"> <li></li> </ul>

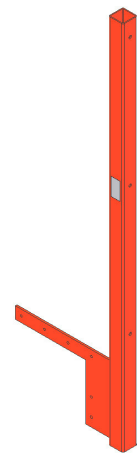
# PERI Rental Criteria

## Suspended Scaffold











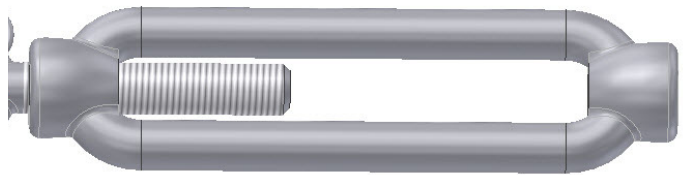





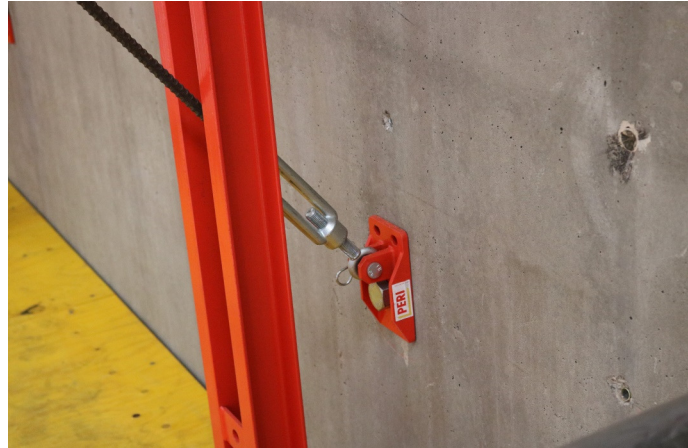

Side Guardrail Post (051610)	Description	Instruction	Billing	Type
	<b>11.81 Plaid bent</b>			
	<ul style="list-style-type: none"> <li>■ If possible</li> </ul>			
	<b>11.82 Bent</b>			
	<ul style="list-style-type: none"> <li>■ If possible</li> </ul>			
	<ul style="list-style-type: none"> <li>■ Or if not possible</li> </ul>			

# PERI Rental Criteria

## Suspended Scaffold











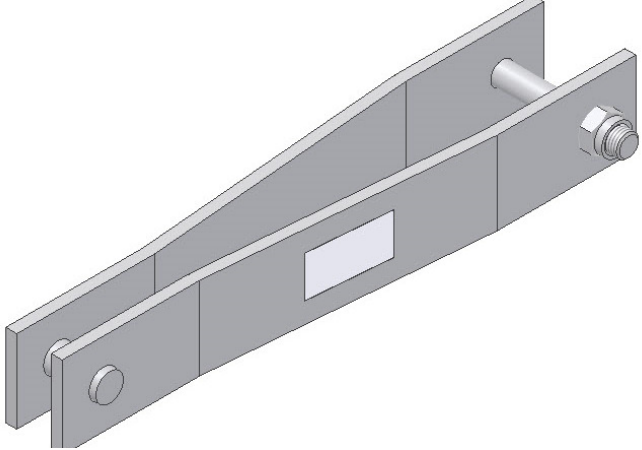

Wall Tension Anchor (107008)	Description	Instruction	Billing	Type
	<b>11.83 Turnbuckle</b>	<ul style="list-style-type: none"> <li>  711059 (Turnbuckle)                 </li> </ul>		
	<ul style="list-style-type: none"> <li> <span data-bbox="875 571 898 587">■</span> Missing                 </li> </ul>	<ul style="list-style-type: none"> <li>  711059 (Turnbuckle)                 </li> </ul>		
	<ul style="list-style-type: none"> <li> <span data-bbox="875 715 898 730">■</span> Or damaged due to force                 </li> </ul>	<ul style="list-style-type: none"> <li>  </li> </ul>		
	<b>11.84 Loop Bolt   Pin   Cotter Pin</b>	<ul style="list-style-type: none"> <li>  711060 (Loop Bolt) 027170 (Pin) 018060 (Cotter Pin)                 </li> </ul>		
	<ul style="list-style-type: none"> <li> <span data-bbox="875 1090 898 1106">■</span> Missing                 </li> </ul>	<ul style="list-style-type: none"> <li>  711060 (Loop Bolt) 027170 (Pin) 018060 (Cotter Pin)                 </li> </ul>		
<ul style="list-style-type: none"> <li> <span data-bbox="875 1233 898 1249">■</span> Or damaged due to force                 </li> </ul>				

# PERI Rental Criteria

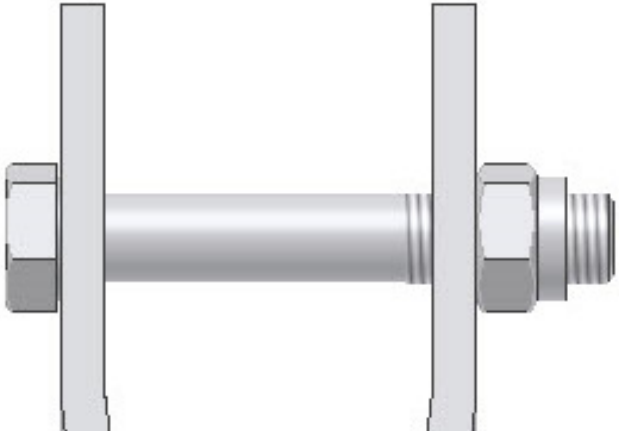
## Suspended Scaffold



















Tension Bolt   Tension Anchor Connector (051260   107007)	Description	Instruction	Billing	Type
	<p><b>11.85 Bent</b></p> <ul style="list-style-type: none"> <li>■ If possible</li> <li>■ Or if not possible</li> </ul>	<ul style="list-style-type: none"> <li></li> <li></li> </ul>	<ul style="list-style-type: none"> <li></li> <li></li> </ul>	<ul style="list-style-type: none"> <li></li> <li></li> </ul>
	<p><b>11.86 Bolt   Nut missing</b></p>	<ul style="list-style-type: none"> <li> 710219 (Bolt) 070890 (Nut)</li> </ul>	<ul style="list-style-type: none"> <li></li> </ul>	<ul style="list-style-type: none"> <li></li> </ul>

# PERI Rental Criteria

## Suspended Scaffold











Scaffolding Bracket (027110   027060   027070)	Description	Instruction	Billing	Type
	<p><b>11.87 Bent</b></p> <ul style="list-style-type: none"> <li>■ ≤ 5 mm</li> <li>■ Or &gt; 5 mm</li> </ul>	<ul style="list-style-type: none"> <li>■ </li> <li>■  </li> </ul>	<ul style="list-style-type: none"> <li>■ </li> <li>■ </li> </ul>	<ul style="list-style-type: none"> <li>■ </li> <li>■ </li> </ul>
	<p><b>11.88 Crack in welding</b></p> <ul style="list-style-type: none"> <li>■ Without damages in material</li> <li>■ Or with damages of the material</li> </ul>	<ul style="list-style-type: none"> <li>■  </li> <li>■  </li> </ul>	<ul style="list-style-type: none"> <li>■ </li> <li>■ </li> </ul>	<ul style="list-style-type: none"> <li>■ </li> <li>■ </li> </ul>

# PERI Rental Criteria

## Suspended Scaffold









Scaffolding Bracket GB 80 (027110   102926)	Description	Instruction	Billing	Type
	<p><b>11.89 Sliding Piece</b></p> <ul style="list-style-type: none"> <li>■ Missing</li> <li>■ Or damaged due to force</li> </ul>	<p> 115673 (Sliding Piece)</p> <p> 115673 (Sliding Piece)</p>	<p></p> <p></p>	<p></p> <p></p>
	<p><b>11.90 L- Angle bent or cracked</b></p>	<p> 115543 (L- Angle)</p>	<p></p>	<p></p>

# PERI Rental Criteria

## Suspended Scaffold















Scaffolding Bracket GB 80 (027110   102926)	Description	Instruction	Billing	Type
	<b>11.91 Bracket</b>			
	<ul style="list-style-type: none"> <li>■ Missing</li> </ul>	 715144 (Bracket)		
	<ul style="list-style-type: none"> <li>■ Or bent</li> </ul>	 715144 (Bracket)		

# PERI Rental Criteria

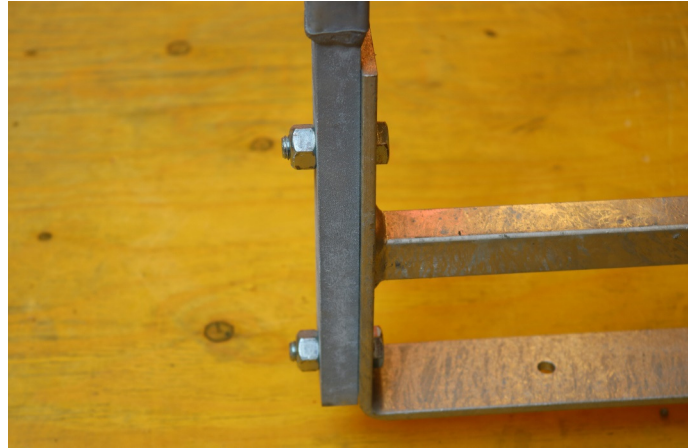
## Suspended Scaffold













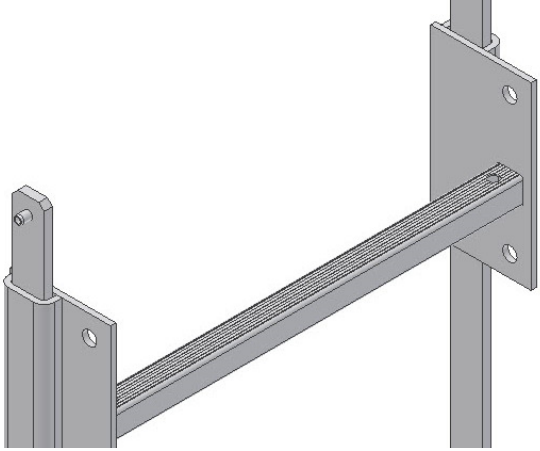

Ladder 180   220 (051410   051420)	Description	Instruction	Billing	Type
	<p><b>11.92 Ladder rung bent</b></p> <ul style="list-style-type: none"> <li>■ Without damages of the welding</li> <li>■ Or with damage of the welding</li> </ul>	<p>Without damages of the welding: </p> <p>Or with damage of the welding:  </p>	<p>Without damages of the welding: </p> <p>Or with damage of the welding: </p>	<p>Without damages of the welding: </p> <p>Or with damage of the welding: </p>
	<p><b>11.93 Bolts   Nuts missing</b></p>	<p> 710224 (Bolt) 710381 (Nut)</p>	<p></p>	<p></p>

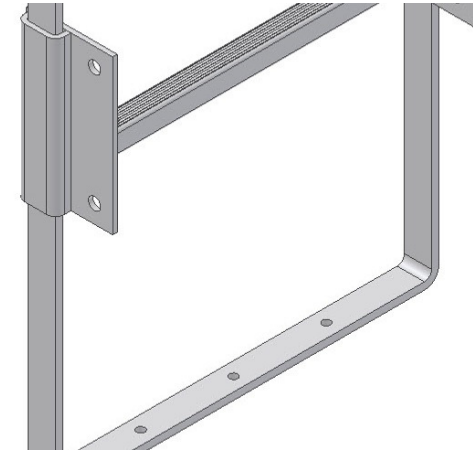

# PERI Rental Criteria

## Suspended Scaffold







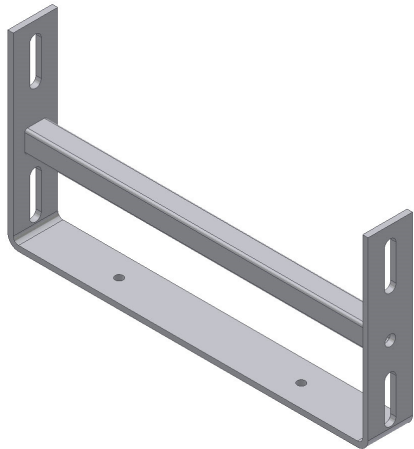

Ladder Base (109105)	Description	Instruction	Billing	Type
	<p><b>11.94 Rung bent</b></p> <ul style="list-style-type: none"> <li>■ Without damages of the welding</li> </ul>			
	<ul style="list-style-type: none"> <li>■ Or with damages of the welding</li> </ul>	 109104 (Rung)		
	<p><b>11.95 Bracket bent</b></p> <ul style="list-style-type: none"> <li>■ If possible</li> </ul>			
	<ul style="list-style-type: none"> <li>■ Or if not possible</li> </ul>	 109102 (Bracket)		

# PERI Rental Criteria

## Suspended Scaffold











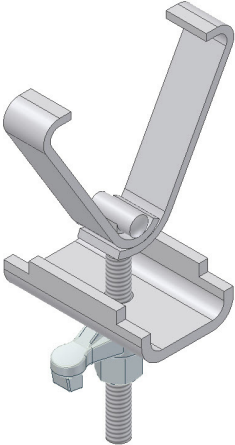

Ladder Base (051460)	Description	Instruction	Billing	Type
	<p><b>11.96 Bent</b></p>			
	<ul style="list-style-type: none"> <li>■ If possible</li> </ul>			
	<ul style="list-style-type: none"> <li>■ Or if not possible</li> </ul>			

# PERI Rental Criteria

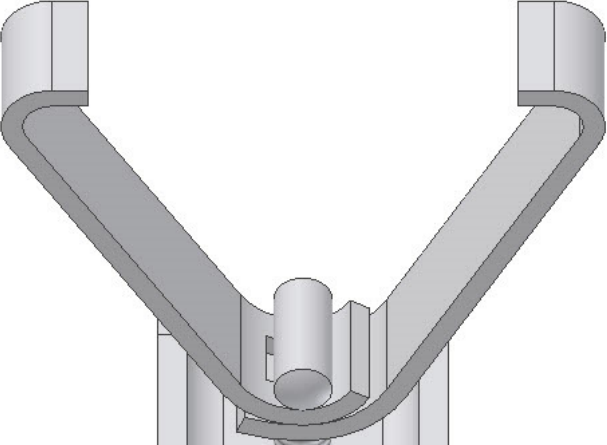
## Suspended Scaffold









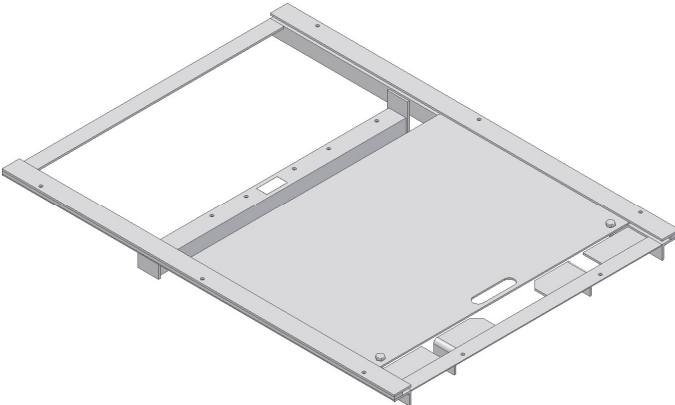

Strongback Connector (051080)	Description	Instruction	Billing	Type
	<p><b>11.97 Wingnut   T- Bolt   Bracket</b></p> <ul style="list-style-type: none"> <li>■ Bent</li> <li>■ Or not moveable due to rust</li> </ul>	<ul style="list-style-type: none"> <li>            710264 (Wingnut)            710263 (T- Bolt)            722137 (Bracket)         </li> <li>  </li> </ul>	<ul style="list-style-type: none"> <li>  </li> <li>  </li> </ul>	<ul style="list-style-type: none"> <li>  </li> <li>  </li> </ul>
		<p><b>11.98 Hook</b></p> <ul style="list-style-type: none"> <li>■ Missing</li> <li>■ Or bent</li> </ul>	<ul style="list-style-type: none"> <li>            710188 (Hook right)            710186 (Hook left)         </li> <li>            710188 (Hook right)            710186 (Hook left)         </li> </ul>	<ul style="list-style-type: none"> <li>  </li> <li>  </li> </ul>

# PERI Rental Criteria

## Suspended Scaffold

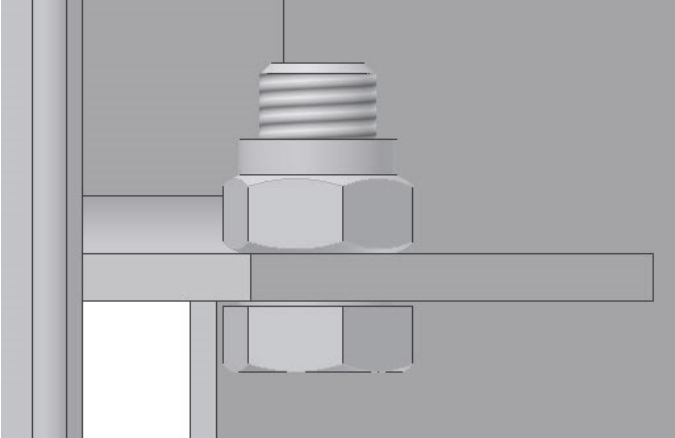

Sliding Hatch (051430)	Description	Instruction	Billing	Type
	<b>11.99 Hatch bent</b>			
	<ul style="list-style-type: none"> <li>■ If possible and moveable afterwards</li> </ul>			
	<ul style="list-style-type: none"> <li>■ Or if not possible</li> </ul>		701283 (Hatch)	
	<b>11.100 Bolt   Nut missing</b>			
			710266 (Bolt) 710381 (Nut)	

# PERI Rental Criteria

## Suspended Scaffold



Platform ASG (105843   105844)	No.	Name	Article number
--------------------------------	-----	------	----------------

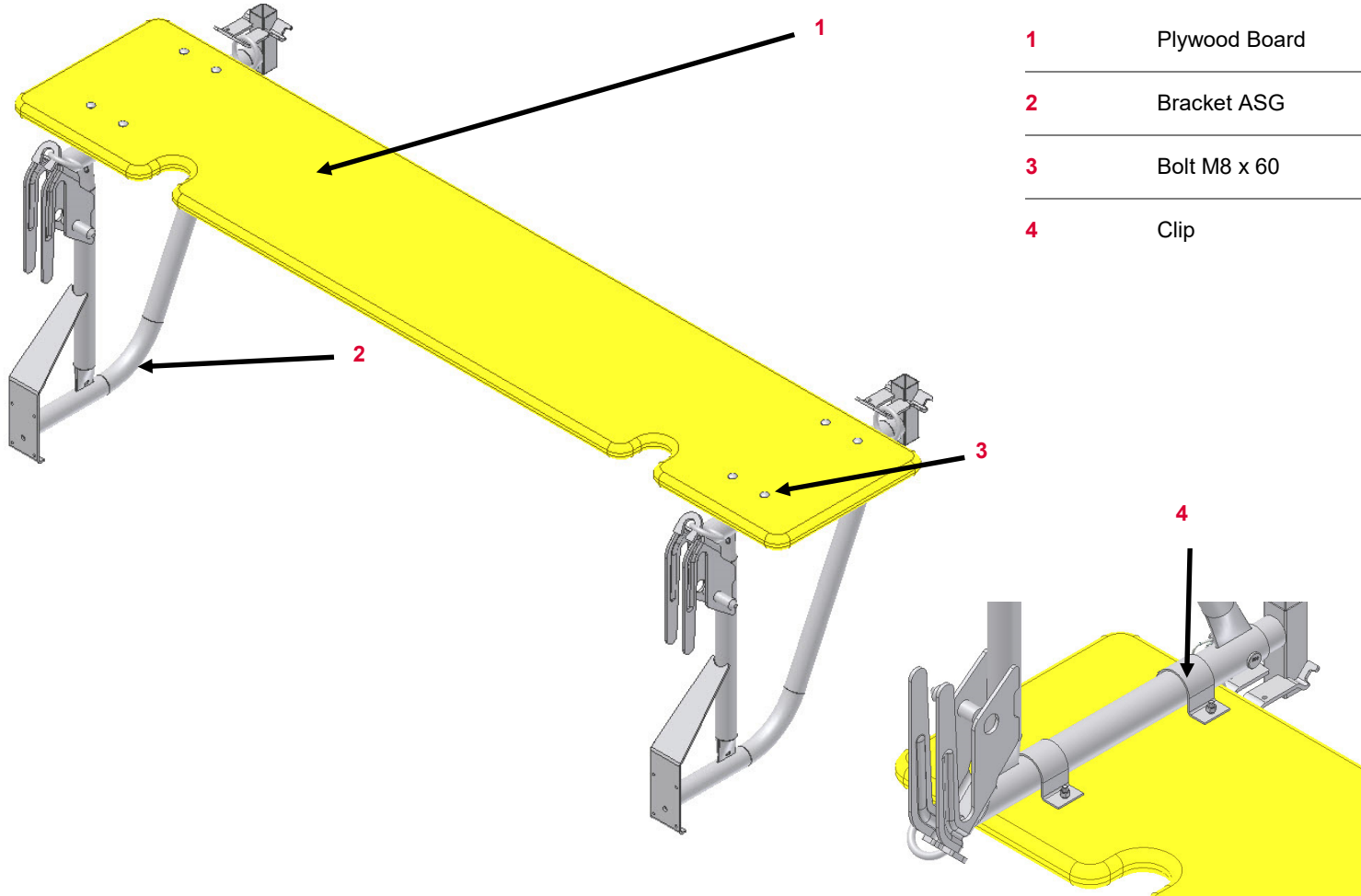















1	Plywood Board	
2	Bracket ASG	105845
3	Bolt M8 x 60	710326
4	Clip	105907

# PERI Rental Criteria

## Suspended Scaffold











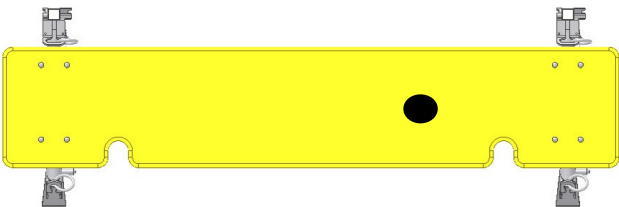





Platform ASG	Description	Instruction	Billing	Type
 <p>286.23.01a Schichtholzplatte erneuern</p>	<b>11.101 Corner damages in Plywood Board</b>	<ul style="list-style-type: none"> <li>  May not be a trip hazard                 </li> </ul>		
	<ul style="list-style-type: none"> <li> <b>■ ≤ 3 cm</b> </li> </ul>	<ul style="list-style-type: none"> <li>  105842 (70-100 x 240) 105841 (70-100 x 248)                 </li> </ul>		
 <p>298.20.03a Schichtholzplatte beschädigt</p>	<b>11.102 Cuts   Splintering</b>	<ul style="list-style-type: none"> <li>  May not be a trip hazard                 </li> </ul>		
	<ul style="list-style-type: none"> <li> <b>■ Or &gt; 3 cm</b> </li> </ul>	<ul style="list-style-type: none"> <li>  105842 (70-100 x 240) 105841 (70-100 x 248)                 </li> </ul>		

# PERI Rental Criteria

## Suspended Scaffold











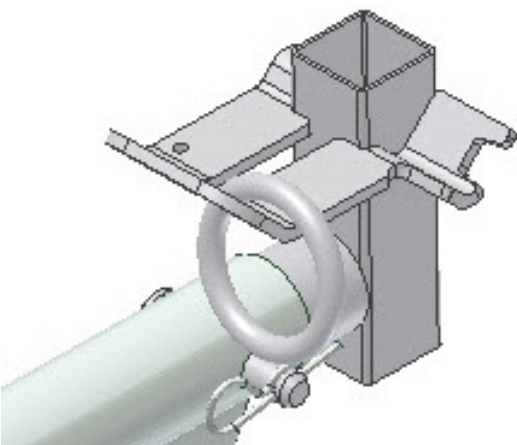





Platfrom ASG	Description	Instruction	Billing	Type
	<p><b>11.103 Drill holes</b></p>			
	<ul style="list-style-type: none"> <li>■ <math>\leq \text{Ø } 20 \text{ mm}</math> and max. 1 each <math>\text{m}^2</math></li> </ul>	 		
	<ul style="list-style-type: none"> <li>■ Or <math>&gt; \text{Ø } 20 \text{ mm}</math></li> </ul>	 <p>105842 (70-100 x 240) 105841 (70-100 x 248)</p>		
<ul style="list-style-type: none"> <li>■ Or more than 1 each <math>\text{m}^2</math></li> </ul>	 <p>105842 (70-100 x 240) 105841 (70-100 x 248)</p>			
	<p><b>11.104 Plywood Board Worn</b></p>	 <p>105842 (70-100 x 240) 105841 (70-100 x 248)</p>		

# PERI Rental Criteria

## Suspended Scaffold



Bracket ASG (105845)	Description	Instruction	Billing	Type
	<b>11.105 Guardrail Post Connection bent</b>	<ul style="list-style-type: none"> <li>Guardrail Post can be inserted </li> </ul>		
	<ul style="list-style-type: none"> <li>Or inserting not possible</li> </ul>	 106184 (Guardrail Post Connection) 106031 (Pin) 018060 (Cotter Pin)		
	<b>11.106 Bracket Bent</b>	<ul style="list-style-type: none"> <li>If possible </li> </ul>		
	<ul style="list-style-type: none"> <li>Or if not possible</li> </ul>			



# PERI Rental Criteria

## Suspended Scaffold



Main Platform ASG 160/240 (026580)	No.	Name	Article number
------------------------------------	-----	------	----------------

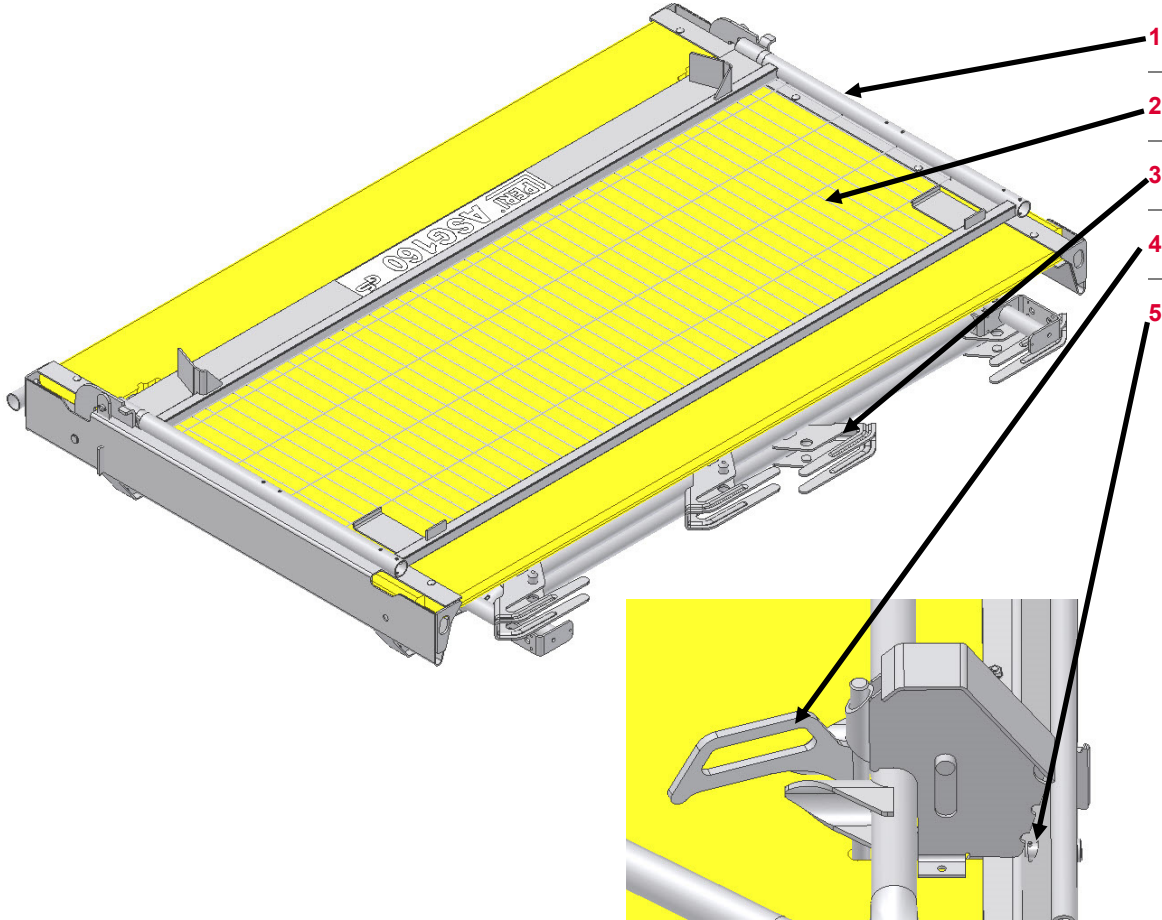

1	Platform ASG	716223
2	Rear Handrail Section	101805
3	Bracket ASG 160	026520
4	Safety Latch	710680
5	Pin	710682

# PERI Rental Criteria

## Suspended Scaffold



Main Platform ASG 160/240	Description	Instruction	Billing	Type
---------------------------	-------------	-------------	---------	------



11.107 Mesh broken

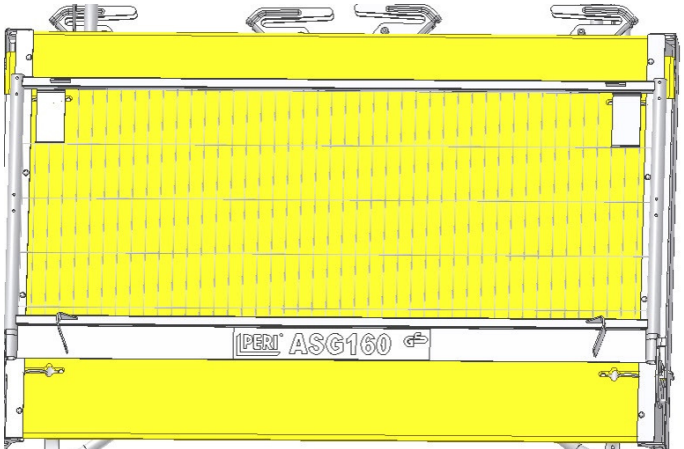

11.108 Plywood Board

- Damages > 3 cm



- Or worn



# PERI Rental Criteria

## Suspended Scaffold



Cavity Wall Suspension (108870)	No.	Name	Article number
---------------------------------	-----	------	----------------

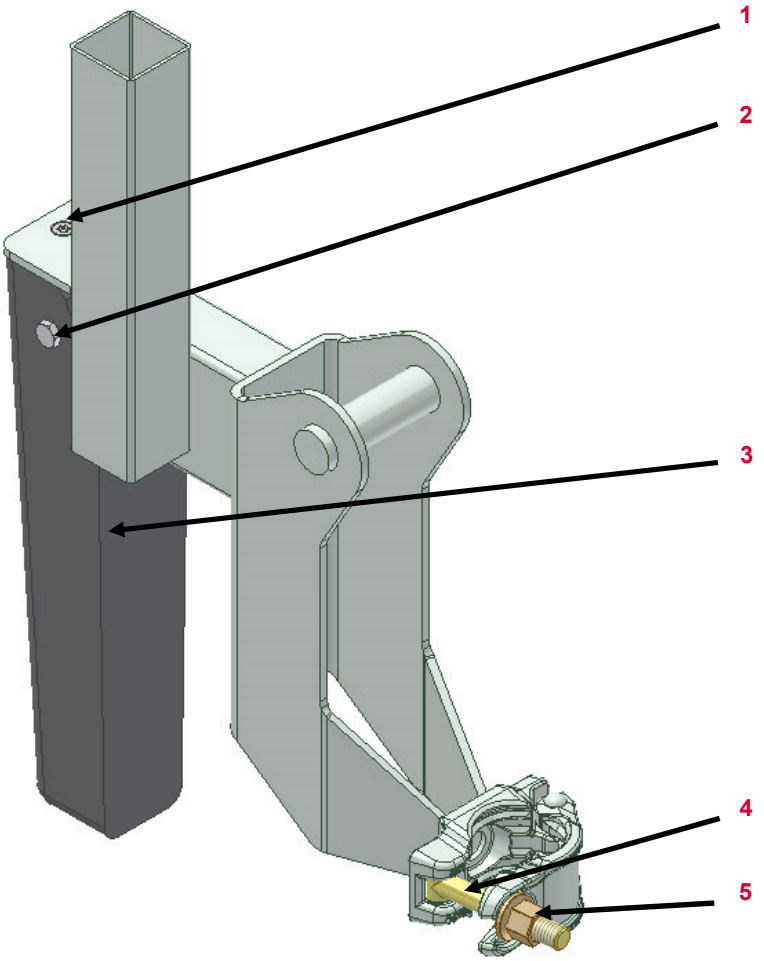









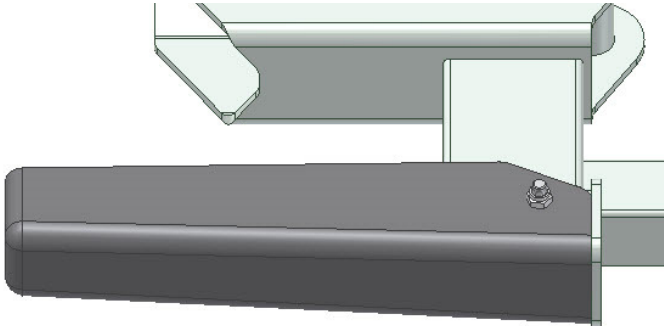

1	Tapping Screw	021770
2	Bolt	108900
3	Cover	108869
4	Hammer Head Bolt	131316
5	Nut	710340

# PERI Rental Criteria

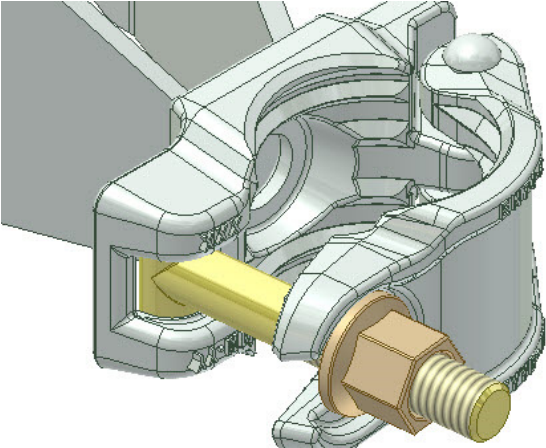
## Suspended Scaffold



















Cavity Wall Suspension	Description	Instruction	Billing	Type
	<p><b>11.109 Cover</b></p> <ul style="list-style-type: none"> <li>■ Missing</li> <li>■ Or damaged due to force</li> </ul>	<p>     </p>	<p>     </p>	<p>     </p>
	<p><b>11.110 Hammer Head Bolt   Nut missing</b></p>	<p>  </p>	<p>  </p>	<p>  </p>

# PERI Rental Criteria

## Glossary Icons



Icon	Significance	Icon	Significance	Icon	Significance
	Not OK – Scrap		Compensation (customer)		Optical damage– it’s permitted to handle out
	OK— Article stays in Rental Park		No compensation		Functional damage– it’s permitted to handle out
	It’s <b>not</b> permitted to handle out the article because of security aspects		Shorten the article		Functional damage– it’s <b>not</b> permitted to handle out
	Repair according to Working Instruction		Mark article		Static damage– it’s <b>not</b> permitted to handle out
	Fix article cold, afterwards check weld seams and bordering components		Replace defect components		
	Repair after local profitability calculation		Replace missing components		
	Clean the article				