

PERI Rental Criteria

PD 5 Shoring



Contact

PERI GmbH
Formwork Scaffolding
Engineering
 P.O. Box 1264
 89264 Weissenhorn, Germany
 Phone +49 (0) 7309.950-0
 Fax +49 (0) 7309.951-0
 rental-criteria@peri.de

Content	Page
PD 5 Frame	2
Diagonal Brace PD 5	6
Beam Waler	9
Base Spindle	10
Beam Spindle	11
Crosshead Spindle TR 48	13
Accessories	15
Glossary	20

Changes made	Date Initial	Page
New Version	09/2018 fw	

PERI Rental Criteria

PD 5 Shoring



PD 5 Frame 150 100 (132468 132464)	No.	Name	Article number
--	-----	------	----------------

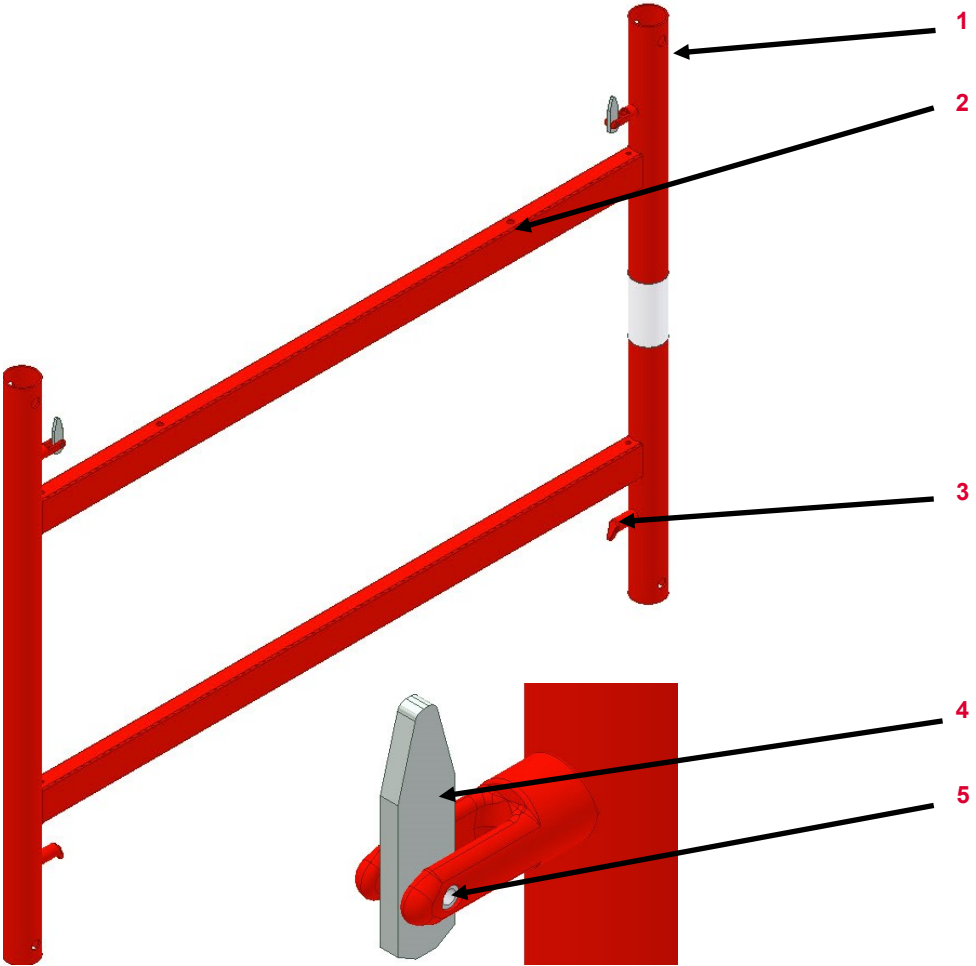









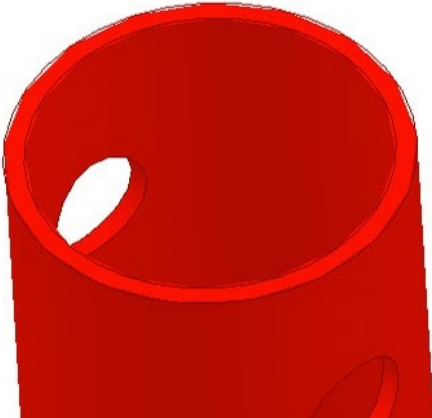



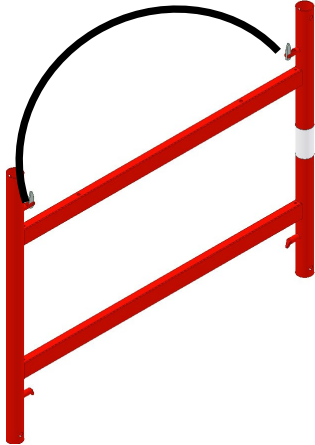

1	Vertical tube	
2	Horizontal tube	
3	Pin	
4	Plaid	710123
5	Sleeve	710910

PERI Rental Criteria

PD 5 Shoring



PD 5 Frame	Description	Instruction	Billing	Type
	<p>15.01 Tube at connection area bent</p> <ul style="list-style-type: none"> ■ If possible and no cracks in material ■ Or if not possible ■ Or cracks in material ■ Or > 5 mm deep 	<p>    </p>	<p>   </p>	<p>   </p>
		<p>15.02 Frame Bent</p> <ul style="list-style-type: none"> ■ ≤ 3 mm (l/500) ■ Or > 3 mm (l/500) 	<p>    </p>	<p>   </p>

PERI Rental Criteria

PD 5 Shoring



PD 5 Frame	Description	Instruction	Billing	Type
------------	-------------	-------------	---------	------



15.03 Horizontal tube bent

- Edges of tube not affected
- Or edges affected

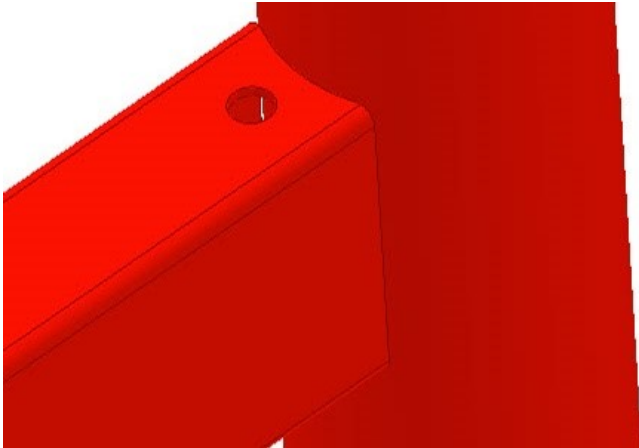



















15.04 Crack in welding



PERI Rental Criteria

PD 5 Shoring



PD 5 Frame	Description	Instruction	Billing	Type
	<p>15.05 Plaid</p> <ul style="list-style-type: none"> ■ Bent ■ Or missing 	<ul style="list-style-type: none">  710123 (Plaid) 710910 (Sleeve)  710123 (Plaid) 710910 (Sleeve) 	<ul style="list-style-type: none">   	<ul style="list-style-type: none">  
	<p>15.06 Pin bent</p> <ul style="list-style-type: none"> ■ If possible ■ Or if not possible ■ Or with crack in material 	<ul style="list-style-type: none">      	<ul style="list-style-type: none">    	<ul style="list-style-type: none">   

PERI Rental Criteria

PD 5 Shoring



Diagonal Brace PD 5	No.	Name	Article number
---------------------	-----	------	----------------

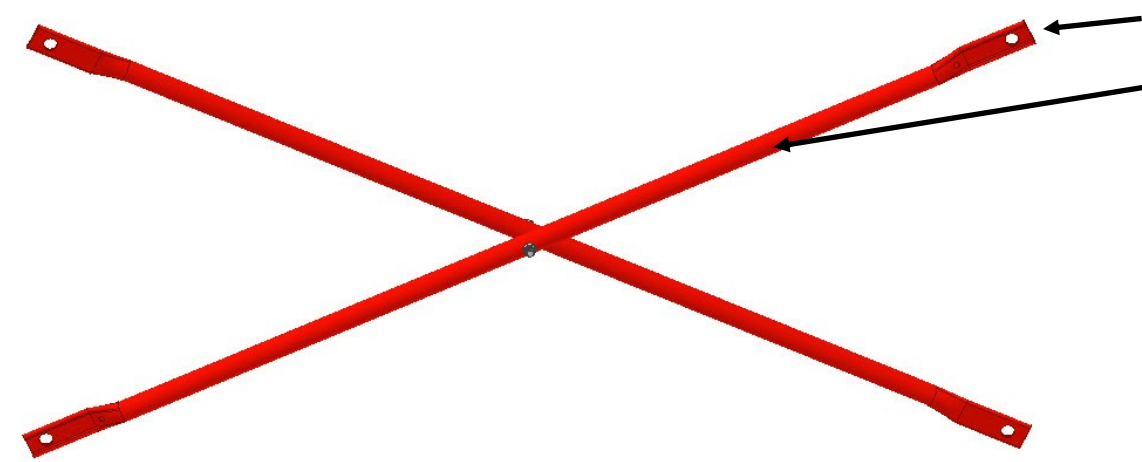

1	Connection	
2	Brace	
3	Bolt M 12 x 85	710254
4	Nut M 12	710381

Valid for



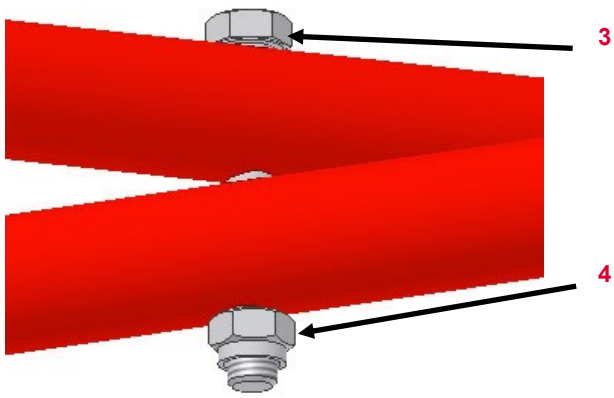

















Diagonal Brace PD 5 150	132470
Diagonal Brace PD 5 200	132472
Diagonal Brace PD 5 250	132474



PERI Rental Criteria

PD 5 Shoring











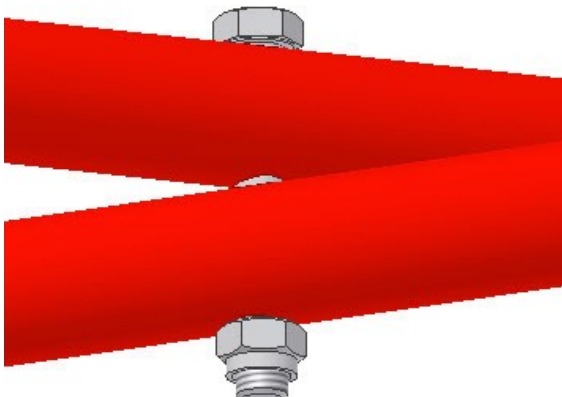



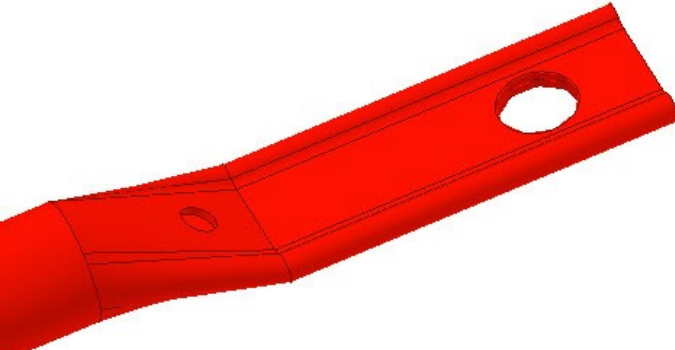

Diagonal Brace PD 5	Description	Instruction	Billing	Type
	<p>15.07 Brace bent</p> <ul style="list-style-type: none"> ■ \leq permitted bent $l/500$ ■ Or $<$ permitted bent $l/500$ 	<ul style="list-style-type: none"> ■  ■   	<ul style="list-style-type: none"> ■  ■  	<ul style="list-style-type: none"> ■  ■ 
	<p>15.08 Dent in tube</p> <ul style="list-style-type: none"> ■ Depth \leq 5 mm ■ Or depth $>$ 5 mm ■ Or kink 	<ul style="list-style-type: none"> ■  ■   ■   	<ul style="list-style-type: none"> ■  ■  ■  	<ul style="list-style-type: none"> ■  ■  ■ 

PERI Rental Criteria

PD 5 Shoring



Diagonal Brace PD 5	Description	Instruction	Billing	Type
	<p>15.09 Bolts Nuts</p>			
	<ul style="list-style-type: none"> ■ Worn 	 710254 (Bolt) 710381 (Nut)		
	<p>15.10 Connection bent</p>			
	<ul style="list-style-type: none"> ■ $\leq 15^\circ$ 			
	<ul style="list-style-type: none"> ■ Or $> 15^\circ$ 			
<ul style="list-style-type: none"> ■ Or cracks in material 				

PERI Rental Criteria

PD 5 Shoring



PD 5 Beam Waler (132540)	Description	Instruction	Billing	Type
--------------------------	-------------	-------------	---------	------



15.11 Plaids bent

- If possible
- Or if not possible
- Or cracks in material

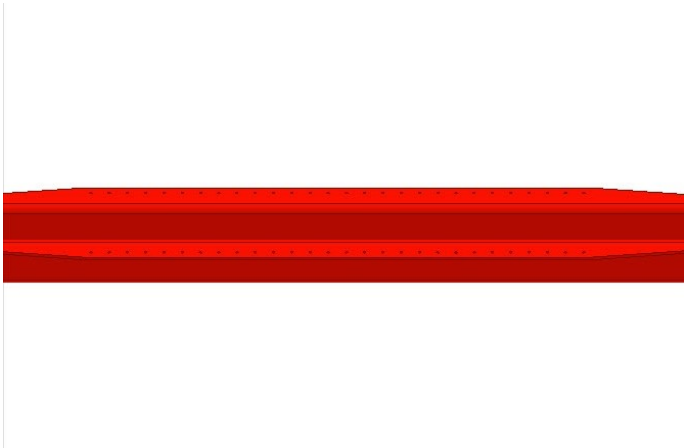

15.12 Bent











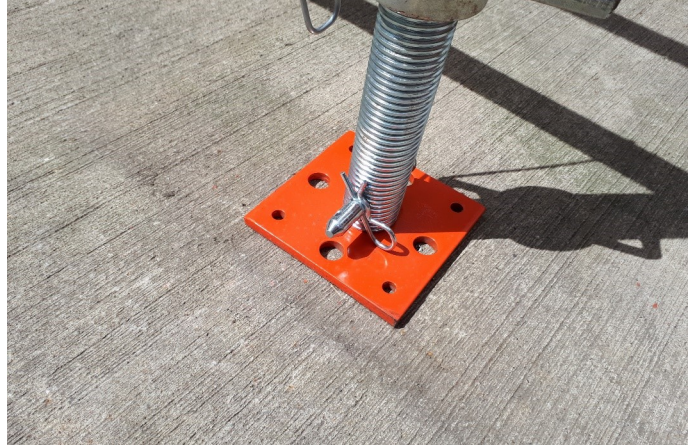



- If possible
- Or if not possible
- Or cracks in material



PERI Rental Criteria

PD 5 Shoring



Base Spindle TR 48-75/55 (132584)	Description	Instruction	Billing	Type
	<p>15.13 Base plate bent</p> <ul style="list-style-type: none"> ■ If possible and no cracks in material ■ Or if not possible ■ Or cracks in material 	<ul style="list-style-type: none">    	<ul style="list-style-type: none">    	<ul style="list-style-type: none">   
	<p>15.14 Cam nut broken</p>	<ul style="list-style-type: none">  127604 (Cam nut) 	<ul style="list-style-type: none">  	<ul style="list-style-type: none"> 

PERI Rental Criteria

PD 5 Shoring



PD 5 Beam Spindle (132457)	Description	Instruction	Billing	Type
----------------------------	-------------	-------------	---------	------



15.15 Inner or outer tube bent

■ If moveable



■ Or if not moveable



132456 (Outer tube)
132452 (Inner tube)



15.16 G- Hook

■ Bent



■ Or unusable



131920 (G- Hook)



■ Or missing













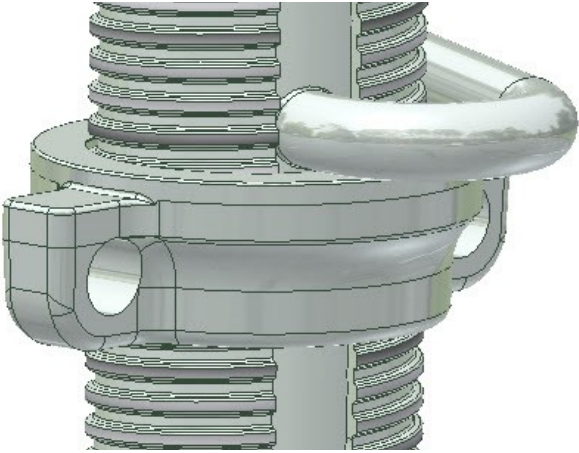



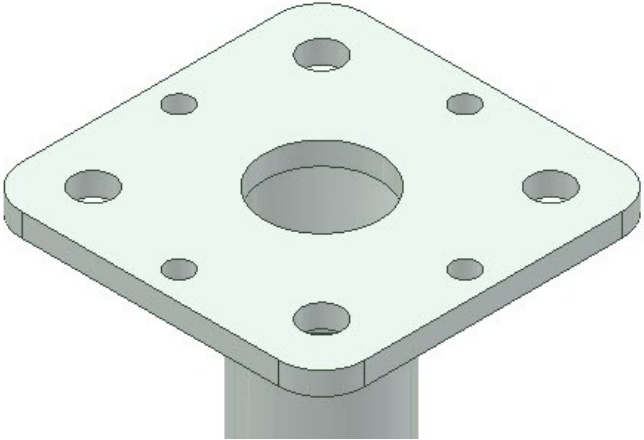

131920 (G- Hook)



PERI Rental Criteria

PD 5 Shoring



PD 5 Beam Spindle (132457)	Description	Instruction	Billing	Type
	15.17 Adjusting nut			
	<ul style="list-style-type: none"> ■ Worn 	 		
	15.18 Base plate bent			
	<ul style="list-style-type: none"> ■ If possible 			
	<ul style="list-style-type: none"> ■ Or if not possible 	 		
<ul style="list-style-type: none"> ■ Or crack in welding 	 			

PERI Rental Criteria

PD 5 Shoring



Cross Head Spindle TR 48-75/47 (018630)	Description	Instruction	Billing	Type
	15.19 Plaid bent			
	■ Bent without crack in welding			
	■ Or bent with crack in welding			
	■ Or missing			
	15.20 Base plate bent			
	■ > 5 mm			

PERI Rental Criteria

PD 5 Shoring



Cross Head Spindle TR 48-75/47 (018630)	Description	Instruction	Billing	Type
---	-------------	-------------	---------	------



15.21 Spindle bent

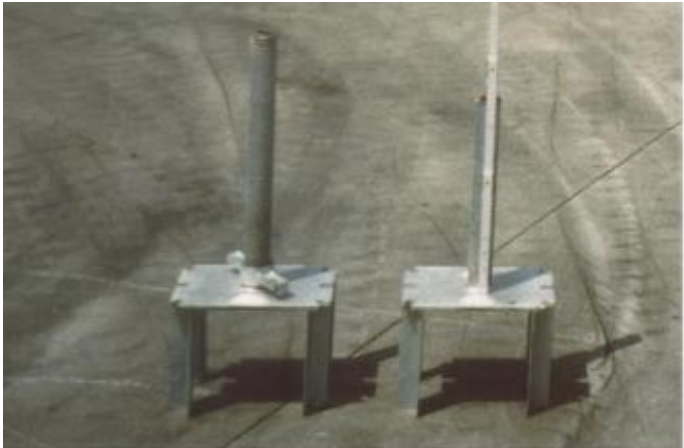

15.22 Spindle

- Cut off



- Or missing

















- Or thread damaged (wingnut not moveable)



PERI Rental Criteria

PD 5 Shoring













Connector with washer (018140)	Description	Instruction	Billing	Type
	<p>15.23 Washer bent</p> <ul style="list-style-type: none"> ■ ≤ 10 mm ■ Or > 10 mm ■ Or loose missing 	<ul style="list-style-type: none">    	<ul style="list-style-type: none">    	<ul style="list-style-type: none">   
	<p>15.24 Tube squeezed</p> <ul style="list-style-type: none"> ■ $\varnothing > 5$ mm 	<ul style="list-style-type: none">  	<ul style="list-style-type: none">  	<ul style="list-style-type: none"> 

PERI Rental Criteria

PD 5 Shoring











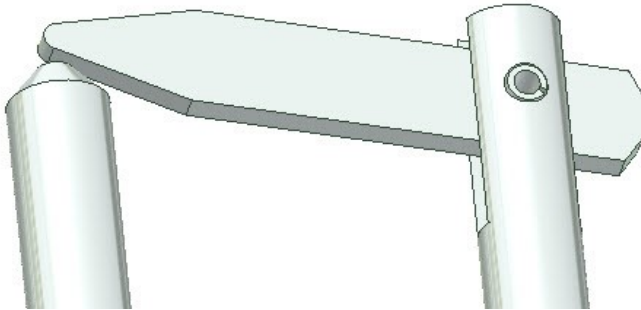

Screwable Flip Lock (132541)	Description	Instruction	Billing	Type
	<p>15.25 Plaid</p> <ul style="list-style-type: none"> ■ Bent ■ Or missing 	<ul style="list-style-type: none">  710123 (Plaid) 710910 (Dowel pin)  710123 (Plaid) 710910 (Dowel pin) 	<ul style="list-style-type: none">   	<ul style="list-style-type: none">  
	<p>15.26 Nut missing</p>	<ul style="list-style-type: none">  112786 (Nut) 	<ul style="list-style-type: none">  	<ul style="list-style-type: none"> 

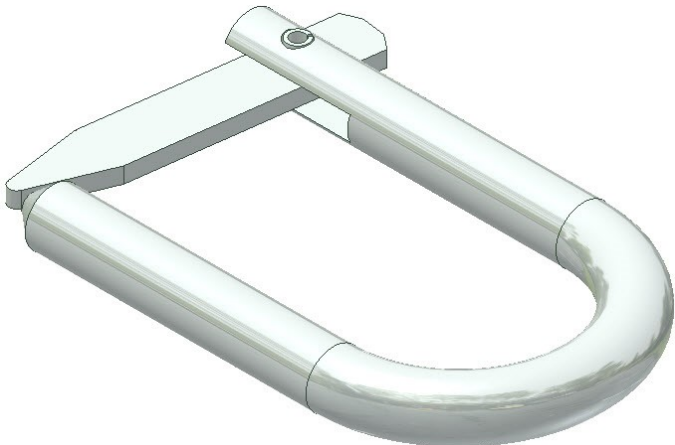
PERI Rental Criteria

PD 5 Shoring



Double Pin Frame (132550)	Description	Instruction	Billing	Type
	<p>15.27 Plaid</p>			
	<ul style="list-style-type: none"> ■ Missing 	 132546 (Plaid) 132549 (Sleeve)		
	<p>15.28 Bent</p>			
	<ul style="list-style-type: none"> ■ Function given 			
<ul style="list-style-type: none"> ■ Or if not given 				

PERI Rental Criteria

PD 5 Shoring



Double Pin Beam Waler (132544)	Description	Instruction	Billing	Type
--------------------------------	-------------	-------------	---------	------

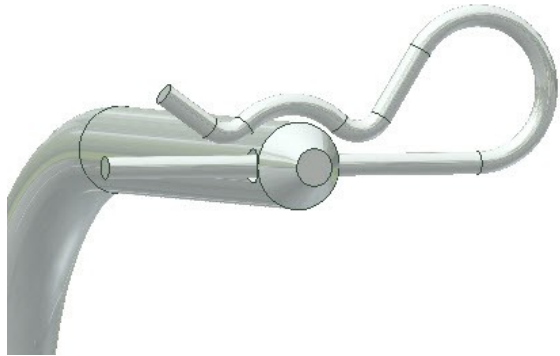

15.29 Cotter Pin missing



018060 (Cotter Pin)



15.30 Bent



PERI Rental Criteria

PD 5 Shoring



















PD 5 Spindle Safety Strap (132864)	Description	Instruction	Billing	Type
	15.31 Bent			
	<ul style="list-style-type: none"> ■ Function given and no cracks in material 			
	<ul style="list-style-type: none"> ■ Or function not given 			
<ul style="list-style-type: none"> ■ Or cracks in material 				

PERI Rental Criteria

Glossar Icons



Icon	Significance	Icon	Significance	Icon	Significance
	Not OK – Scrap		Compensation (customer)		Optical damage– it’s permitted to handle out
	OK— Article stays in Rental Park		No compensation		Functional damage– it’s permitted to handle out
	It’s not permitted to handle out the article because of security aspects		Shorten the article		Functional damage– it’s not permitted to handle out
	Repair according to Working Instruction		Mark article		Statical damage– it’s not permitted to handle out
	Fix article cold		Replace defect components		
	Repair after local profitability calculation		Replace missing components		
	Clean the article				