

PERI Rental Criteria

PERI UP Shoring Scaffold

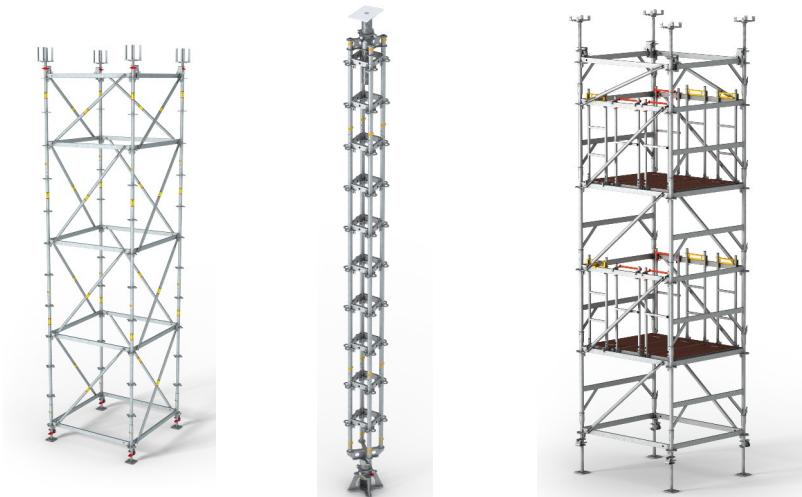

Contact

PERI GmbH
Formwork Scaffolding
Engineering
 P.O. Box 1264
 89264 Weissenhorn, Germany
 Phone +49 (0) 7309.950-0
 Fax +49 (0) 7309.951-0
 rental-criteria@peri.de

Content	Page
PERI UP Flex Heavy Duty Prop HD	2
PERI UP Flex Shoring Tower MDS	12
PERI UP Flex Shoring Tower	18
Transportation Wheel UEW	24
Connection Transportation Wheel	26
Glossary	28

Changes made	Date Initial	Page
New Version	07/2017 fw	

PERI Rental Criteria

PERI UP Shoring Scaffold



Lowering Jack HD (126436)

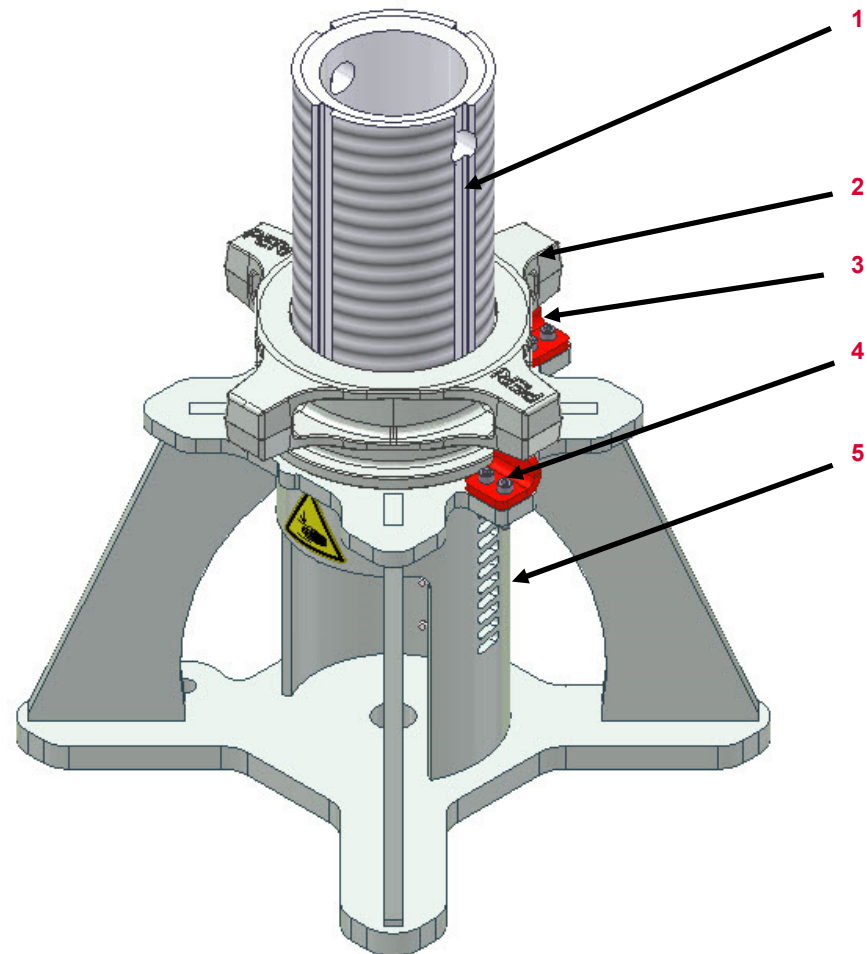

Nr.	Description	Item number
1	Spindle tube	127117
2	Adjusting Nut TR 110x9	780149
3	Downholder	127114
4	Bolt M5x25	127077
5	Foot for lowering jack	127123

PERI Rental Criteria

PERI UP Shoring Scaffold



Lowering Jack HD (126436)	Description	Instruction	Billing condition	Type
---------------------------	-------------	-------------	-------------------	------



33.60.01 Adjusting nut broken



33.60.02 Downholder









- Broken off
- Or missing



PERI Rental Criteria

PERI UP Shoring Scaffold



Lowering Jack HD (126436)	Description	Instruction	Billing condition	Type
	<p>33.60.03 Type plate unreadable</p>			
	<p>33.60.04 Thread damaged</p>			

PERI Rental Criteria

PERI UP Shoring Scaffold



Head Spindle TR 110-80/55 (126435)	Nr.	Description	Item number
------------------------------------	-----	-------------	-------------

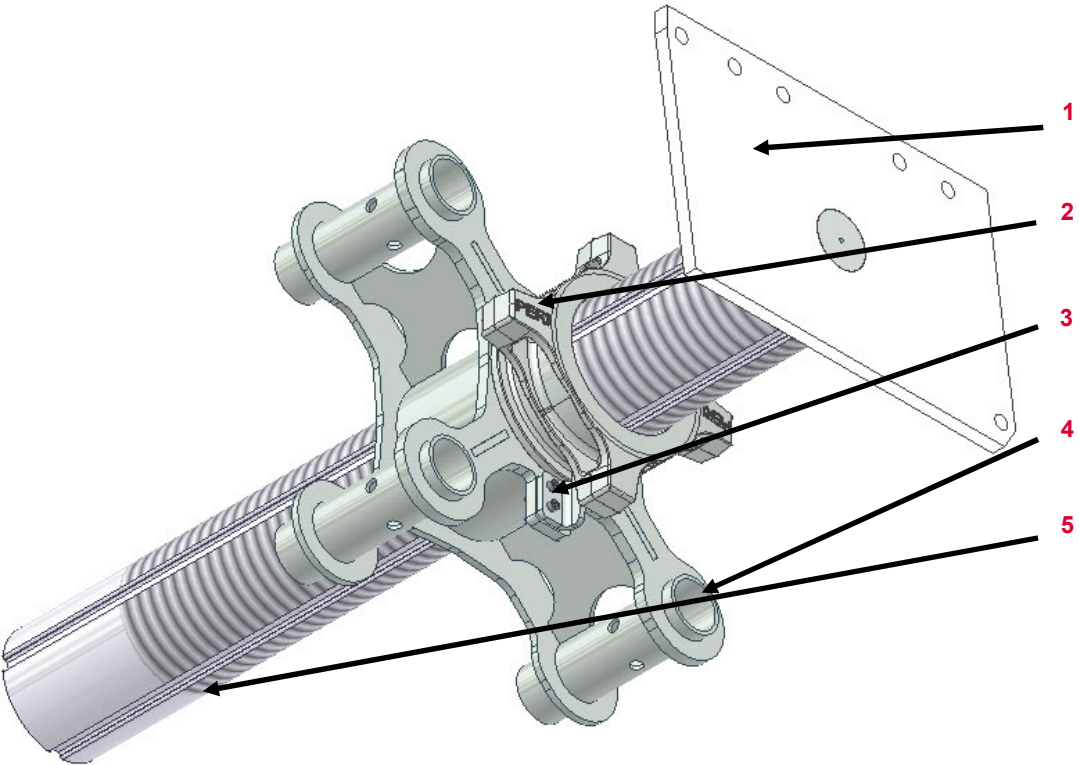







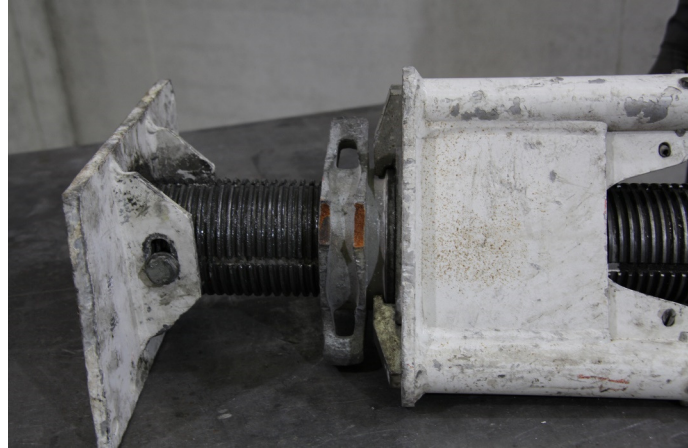

1	Oscillating plate	785263
2	Adjusting nut TR 110x9	780149
3	Holding claw	127101
4	Tube connector	127110
5	Spindle tube	127102

PERI Rental Criteria

PERI UP Shoring Scaffold











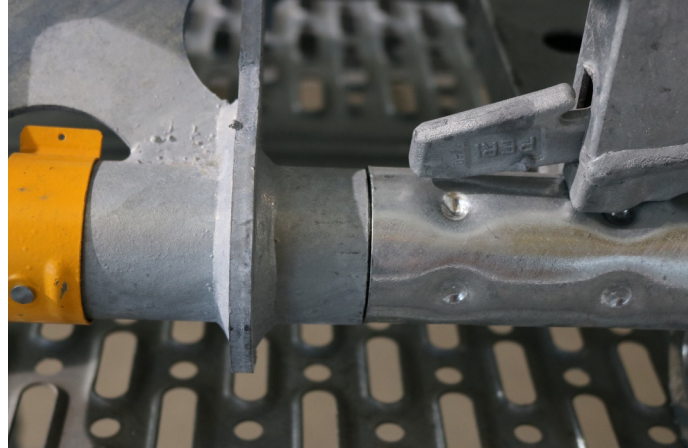







Head Spindle TR 110-80/55 (126435)	Description	Instruction	Billing condition	Type
	<p>33.60.05 Adjusting nut broken</p>			
	<p>33.60.06 Oscillating plate bent</p>			

PERI Rental Criteria

PERI UP Shoring Scaffold



Head Spindle TR 110-80/55 (126435)	Description	Instruction	Billing condition	Type
	33.60.07 Tube connector bent	<ul style="list-style-type: none"> ■ If possible (Tubes can be inserted)  		
	<ul style="list-style-type: none"> ■ Or if no longer possible 			
	<ul style="list-style-type: none"> ■ Or cracks in zinc layer 			
	33.60.08 Holding claw	<ul style="list-style-type: none"> ■ Broken off  		
	<ul style="list-style-type: none"> ■ Or missing 			

PERI Rental Criteria

PERI UP Shoring Scaffold



Hydraulic-Unit HD (126438)	Nr.	Description	Item number
----------------------------	-----	-------------	-------------

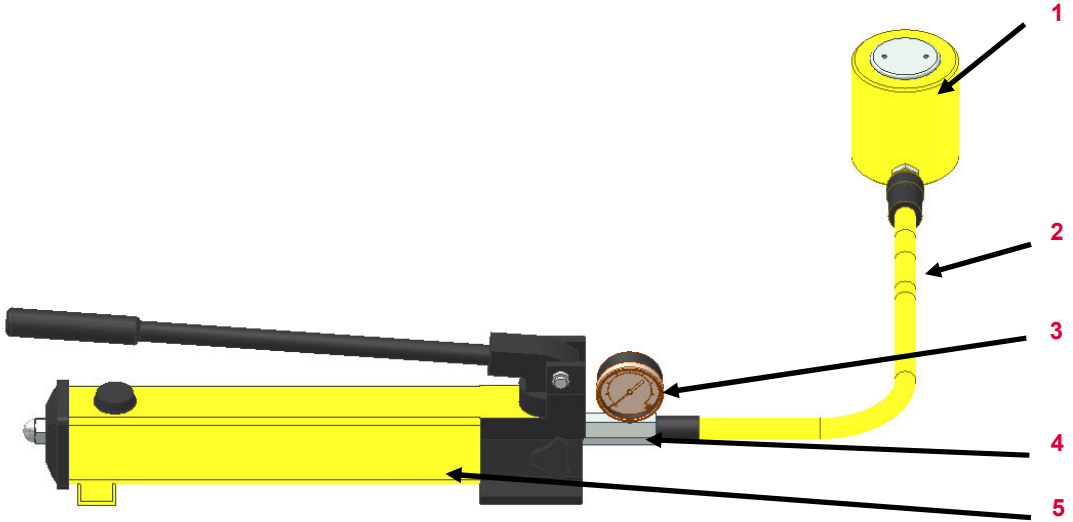















1	Cylinder	130792
2	Hydraulic hose	130791
3	Pressure gauge	130789
4	Pressure gauge connection part	130788
5	Hand pump	130787

PERI Rental Criteria

PERI UP Shoring Scaffold











Hydraulic-Unit HD (126438)	Description	Instruction	Billing condition	Type
	<p>33.60.09 Cylinder not functional</p> <ul style="list-style-type: none"> ■ Due to wear ■ Or damaged due to violence 	<ul style="list-style-type: none">   	<ul style="list-style-type: none">   	<ul style="list-style-type: none">  
	<p>33.60.10 Hose</p> <ul style="list-style-type: none"> ■ Porous ■ Or cut into 	<ul style="list-style-type: none">   	<ul style="list-style-type: none">   	<ul style="list-style-type: none">  

PERI Rental Criteria

PERI UP Shoring Scaffold



Hydraulic-Unit HD (126438)	Description	Instruction	Billing condition	Type
	<p>33.60.11 Pressure gauge not functional</p>			
	<p>33.60.12 Hand pump not functional</p>			

PERI Rental Criteria

PERI UP Shoring Scaffold



Connector UJC (126437)	Description	Instruction	Billing condition	Type
------------------------	-------------	-------------	-------------------	------

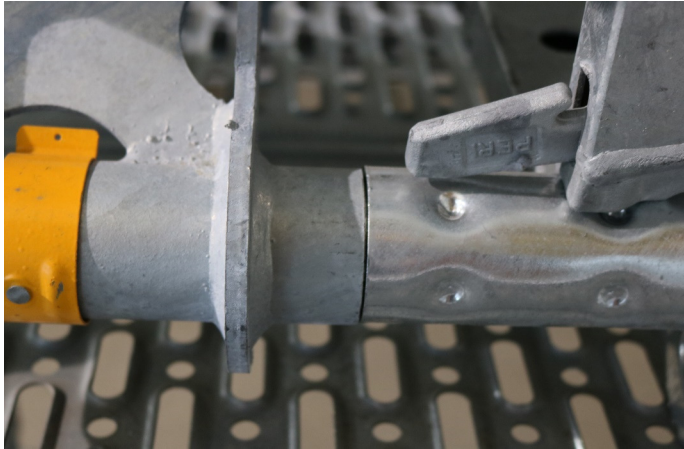

33.60.13 Spigot bent | dented

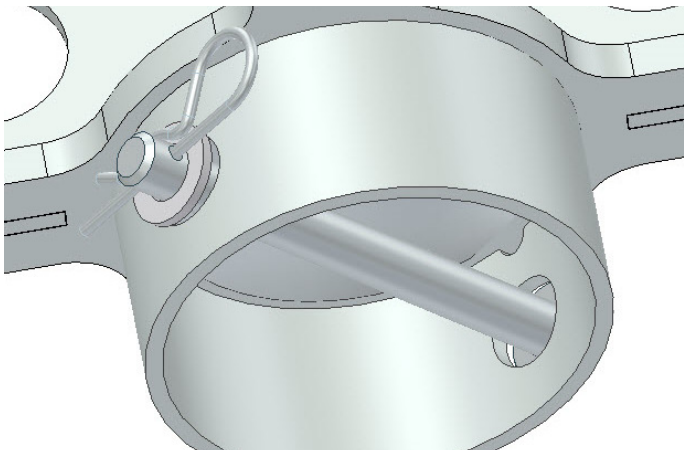

33.60.14 Bolt | Cotter pin

■ Missing



127086 (Bolt)
018060 (Spring Pin)
711074 (Washer)



■ Or bent



127086 (Bolt)
018060 (Spring Pin)
711074 (Washer)



PERI Rental Criteria

PERI UP Shoring Scaffold



Base Frame MDS	Nr.	Description	Item number
----------------	-----	-------------	-------------

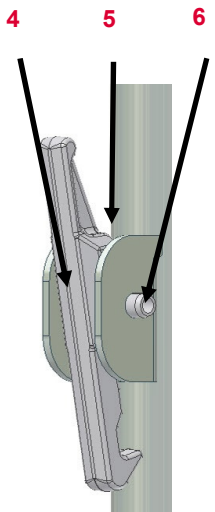
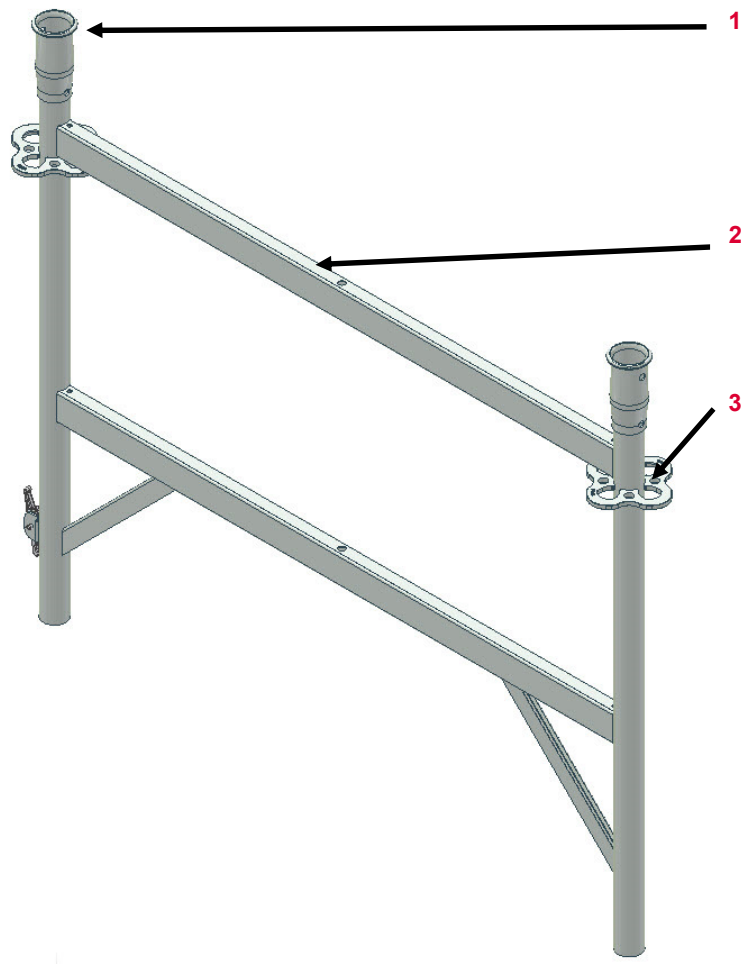



























1	Junction	
2	Horizontal Tube	
3	Rosett	
4	Safety hook	710418
5	Pressure spring	710420
6	Dowel pin	724567

Valid for	
Base Frame MDS 100	112012
Frame MDS 100	112052
End Frame MDS 50	112059
Intermediate Frame MDS 50	112034

PERI Rental Criteria

PERI UP Shoring Scaffold







Frame	Description	Instruction	Billing condition	Type
	33.60.15 Junction spigot bent			
	■ Insertion of spigot possible	 		
	■ Or insertion of spigot not possible	 		
	■ Or cracks in zinc layer	 		
	33.60.16 Rosett bent			
	■ ≤ 20 mm	 		
	■ Or > 20 mm	 		
	■ Or cracks in rosette	 		

PERI Rental Criteria

PERI UP Shoring Scaffold



Frame	Description	Instruction	Billing condition	Type
	33.60.17 Safety hook not movable			

PERI Rental Criteria

PERI UP Shoring Scaffold



Platform MDS 125 (125631)	Nr.	Description	Item number
---------------------------	-----	-------------	-------------

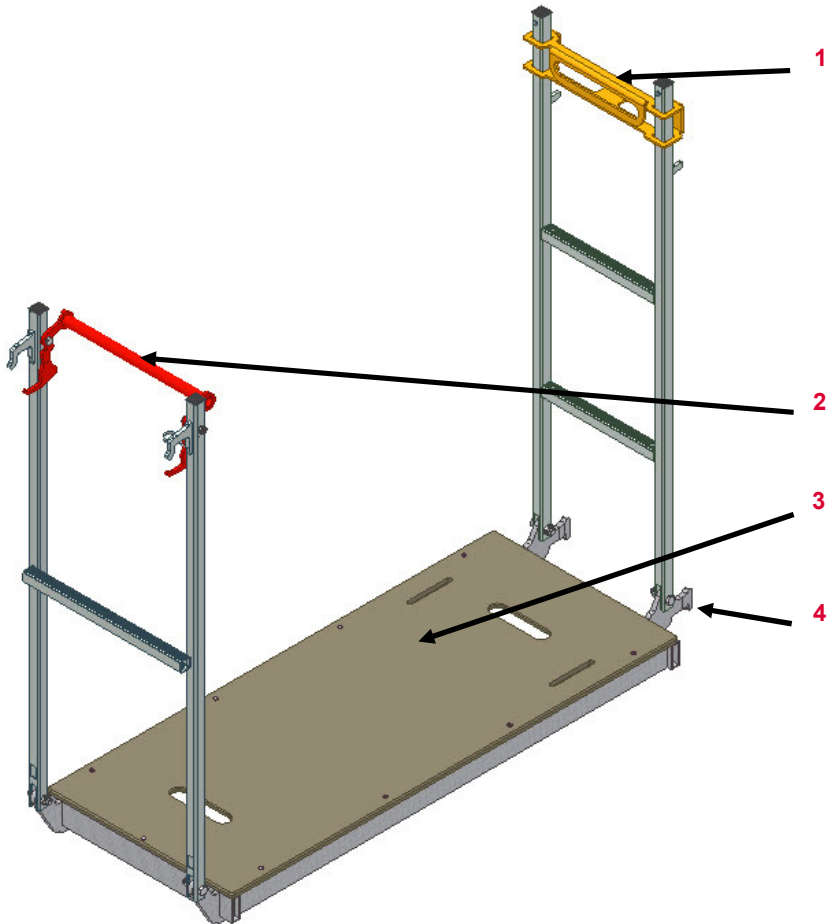



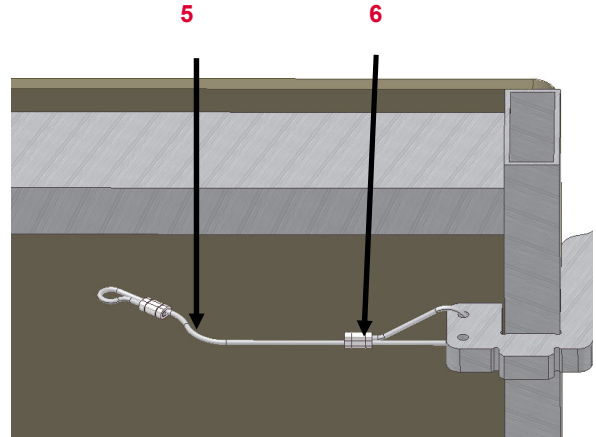













1	Locking	125653
2	Gravity Pawl	125640
3	Wooden deck MDS	125637
4	Connection bracket	
5	Chain	127303
6	Nico Ferrule	127302



PERI Rental Criteria

PERI UP Shoring Scaffold



Platform MDS 125 (125631)	Description	Instruction	Billing condition	Type
	33.60.18 Deck			
	<ul style="list-style-type: none"> <li data-bbox="875 571 1272 609">■ Worn <li data-bbox="875 711 1272 769">■ Or unusable (e.g. broken) due to violence 	<ul style="list-style-type: none"> <li data-bbox="1305 552 1787 609"> <li data-bbox="1305 705 1787 769"> 	<ul style="list-style-type: none"> <li data-bbox="1809 552 2078 609"> <li data-bbox="1809 705 2078 769"> 	<ul style="list-style-type: none"> <li data-bbox="2092 552 2163 609"> <li data-bbox="2092 705 2163 769">
	33.60.19 Connection bracket bent			
	■ If possible			
	■ Or if no longer possible	 Exchange Base Frame (125633)		
■ Or cracks in welding	 Exchange Base Frame (125633)			

PERI Rental Criteria

PERI UP Shoring Scaffold



Platform MDS 125 (125631)	Description	Instruction	Billing condition	Type
---------------------------	-------------	-------------	-------------------	------



33.60.20 Gravity Pawl

- Bent (no longer functional)
- Or missing

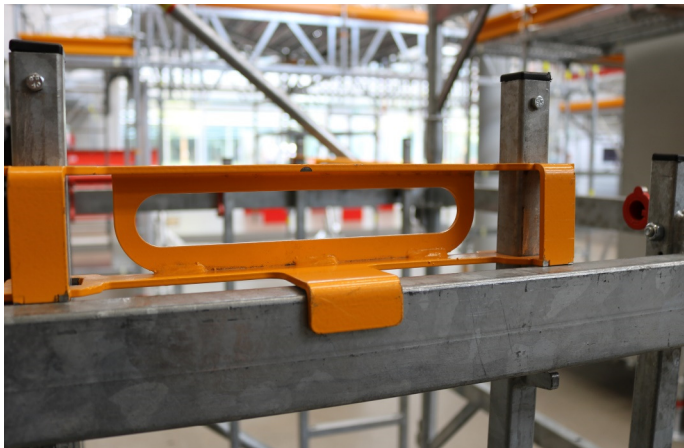

33.60.21 Locking















- Bent (no longer functional)
- Or missing



PERI Rental Criteria

PERI UP Shoring Scaffold











Base and Top Standard (117196; 117197)	Description	Instruction	Billing condition	Type
	<p>33.60.22 Rosett bent</p> <ul style="list-style-type: none"> ■ ≤ 20 mm ■ Or > 20 mm ■ Or cracks in rosett 	<ul style="list-style-type: none">    	<ul style="list-style-type: none">    	<ul style="list-style-type: none">   
	<p>33.60.23 Completely bent</p> <ul style="list-style-type: none"> ■ > 3 mm (L/500) 	<ul style="list-style-type: none">  	<ul style="list-style-type: none">  	<ul style="list-style-type: none"> 

PERI Rental Criteria

PERI UP Shoring Scaffold



Base and Top Standard (117196; 117197)	Description	Instruction	Billing condition	Type
	<p>33.60.24 Junction Spigot bent</p> <ul style="list-style-type: none"> ■ Removal no longer possible ■ Or cracks in material 	<p>   </p> <p>   </p>	<p>  </p> <p>  </p>	<p>  </p> <p>  </p>

PERI Rental Criteria

PERI UP Shoring Scaffold



Shoring Brace UBS	Nr.	Description	Item number
-------------------	-----	-------------	-------------

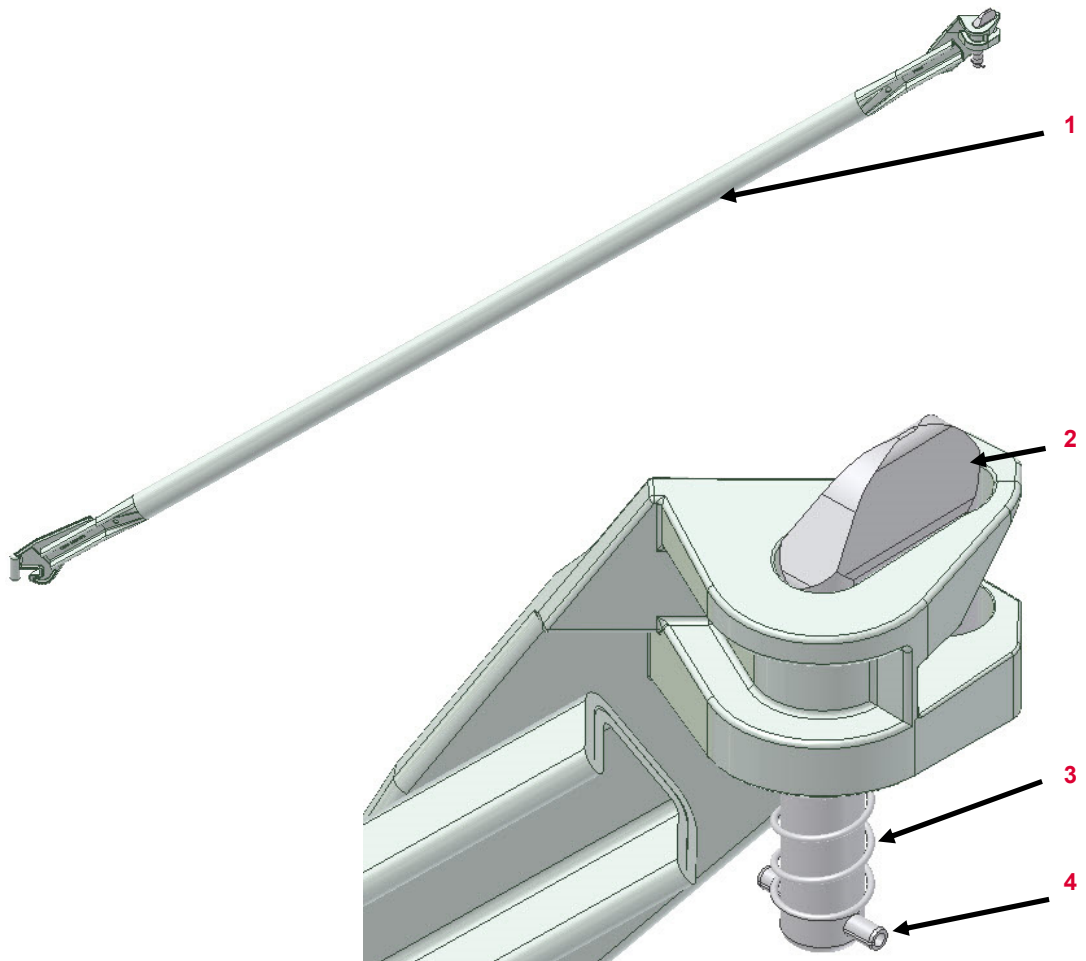











1	Diagonal	
2	Bolt UBK	100520
3	Pressure Spring	722573
4	Dowel pin	710683

Valid for	
Shoring Brace UBS 100/100	128936
Shoring Brace UBS 150/100	107801
Shoring Brace UBS 200/100	115504
Shoring Brace UBS 250/100	123592
Shoring Brace UBS 300/100	123584
Shoring Brace UBS 100/150	129354
Shoring Brace UBS 150/150	107810
Shoring Brace UBS 200/150	115291
Shoring Brace UBS 250/150	123588
Shoring Brace UBS 300/150	123580

PERI Rental Criteria

PERI UP Shoring Scaffold

















Shoring Brace UBS	Description	Instruction	Billing condition	Type
	<p>33.60.25 Spring not functional usable</p>			
	<p>33.60.26 Bolt</p> <ul style="list-style-type: none"> ■ Missing ■ Or broken off 	<ul style="list-style-type: none">   	<ul style="list-style-type: none">   	<ul style="list-style-type: none">  

PERI Rental Criteria

PERI UP Shoring Scaffold













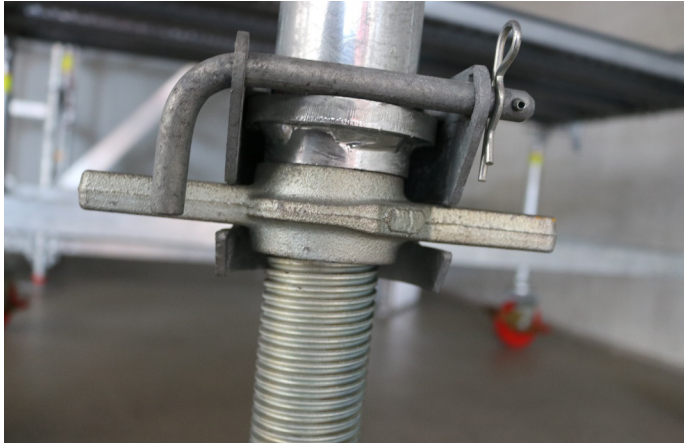

Shoring Brace UBS	Description	Instruction	Billing condition	Type
	<p>33.60.27 Rivet broken off Connection missing</p>			
	<p>33.60.28 Spigot bent</p> <ul style="list-style-type: none"> ■ If possible (Spigot can be inserted) ■ Or if no longer possible ■ Or cracks in material 	<ul style="list-style-type: none">    	<ul style="list-style-type: none">    	<ul style="list-style-type: none">   

PERI Rental Criteria

PERI UP Shoring Scaffold





















Handle Lock UJS Plus (117743)	Description	Instruction	Billing condition	Type
	<p>33.60.29 Bolt Dowel pin Cotter pin</p> <ul style="list-style-type: none"> ■ Missing ■ Or unusable due to violence 	<ul style="list-style-type: none">  118383 (Bolt) 780803 (Dowel Pin) 722966 (Spring Pin)  118383 (Bolt) 780803 (Dowel Pin) 722966 (Spring Pin) 	<ul style="list-style-type: none">   	<ul style="list-style-type: none">  
	<p>33.60.30 Spindle safety bent</p> <ul style="list-style-type: none"> ■ If possible (Functionality given) ■ Or no longer possible 	<ul style="list-style-type: none">   	<ul style="list-style-type: none">   	<ul style="list-style-type: none">  

PERI Rental Criteria

PERI UP Shoring Scaffold













Transportation Wheel UEW (116176)	Description	Instruction	Billing condition	Type
	33.60.31 Brake bent			
	<ul style="list-style-type: none"> ■ Still functional 	 		
	<ul style="list-style-type: none"> ■ Or no longer functional 			
	<ul style="list-style-type: none"> ■ Or pedal broken off 			
	33.60.32 Wheel			
	<ul style="list-style-type: none"> ■ Worn 			
	<ul style="list-style-type: none"> ■ Or parts of profile broken off (wheel not running evenly) 			

PERI Rental Criteria

PERI UP Shoring Scaffold



Transportation Wheel UEW (116176)	Description	Instruction	Billing condition	Type
	<p>33.60.33 Adjustable tube bent</p> <ul style="list-style-type: none"> ■ If possible ■ Or if not possible ■ Or cracks in material 	<ul style="list-style-type: none">    	<ul style="list-style-type: none">    	<ul style="list-style-type: none">   

PERI Rental Criteria

PERI UP Shoring Scaffold



Connection Transportation Wheel (116193; 130507)	Description	Instruction	Billing condition	Type
--	-------------	-------------	-------------------	------



33.60.34 Spring bent | not functional



116177 (Spring)



33.60.35 Locking pin | Spring | Disc | Dowel pin missing



116181 (Bolt)
116177 (Spring)
711043 (Washer)
721925 (Sleeve)



PERI Rental Criteria

PERI UP Shoring Scaffold



Connection Transportation Wheel (116193; 130507)	Description	Instruction	Billing condition	Type
--	-------------	-------------	-------------------	------



33.60.36 Spigot bent

- If possible
- Or if no longer possible
- Or cracks in material

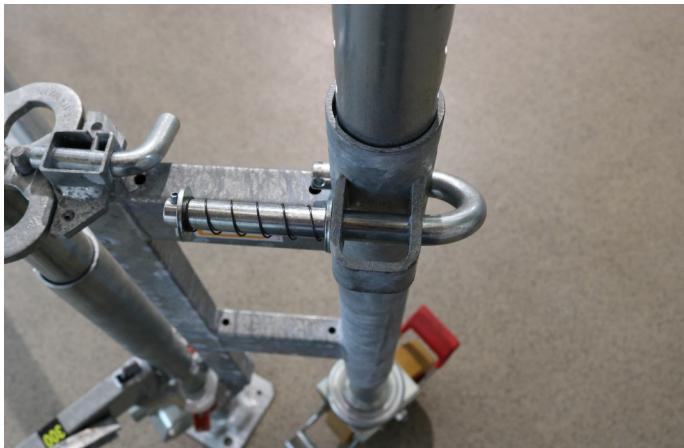

33.60.37 Lead pipe bent

















- Transportation Wheel can be inserted and fixed
- Or can not be inserted



PERI Rental Criteria

Glossary Icons



Icon	Significance	Icon	Significance	Icon	Significance
	Not Ok– material is scrap		Billing necessary (customer)		Optical damage
	OK– material stays in rental park		No Billing necessary		Functional damage
	Scrap material– it's not permitted to hand out the material because of safety aspects		Shorten the material		Functional damage— it's not permitted to hand out the material
	Repair according to instruction		Mark the material		Static damage— it's not permitted to hand out the material
	Fix material cold– Afterwards check weld seams and bordering components		Replace damaged material		
	Repair after local economic efficiency calculation		Replace missing material		
	Clean the material				