

PERI Rental Criteria

HANDSET Alpha

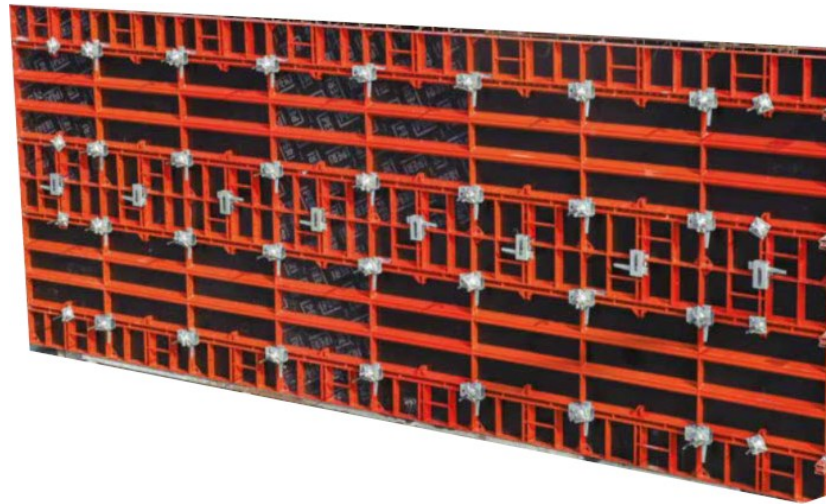

Contact

PERI GmbH
Formwork Scaffolding
Engineering
 P.O. Box 1264
 89264 Weissenhorn, Germany
 Phone +49 (0) 7309.950-0
 Fax +49 (0) 7309.951-0
 rental-criteria@peri.de

Content	Page	Changes made	Date Initial	Page
Panel	2	New Version	09/2020 fw	
Internal Corner	6	Bent frame added	03/2022 fw	5
External Corner	9	Type of damage changed	03/2022 fw	8
Alignment clamp	11	Type of damage changed	03/2022 fw	10
Wedge Clip	12	Billing condition changed	03/2022 fw	15
Compensation Clamp	13	Billing condition changed	03/2022 fw	17
Walers	15	Repair condition at HSGP-2 changed	03/2022 fw	18
Scaffold Bracket	17	External Brace Connector added	03/2022 fw	19-20
Guardrail Post	18			

PERI Rental Criteria

HANDSET Alpha



Panel	No.	Name	Article number
-------	-----	------	----------------

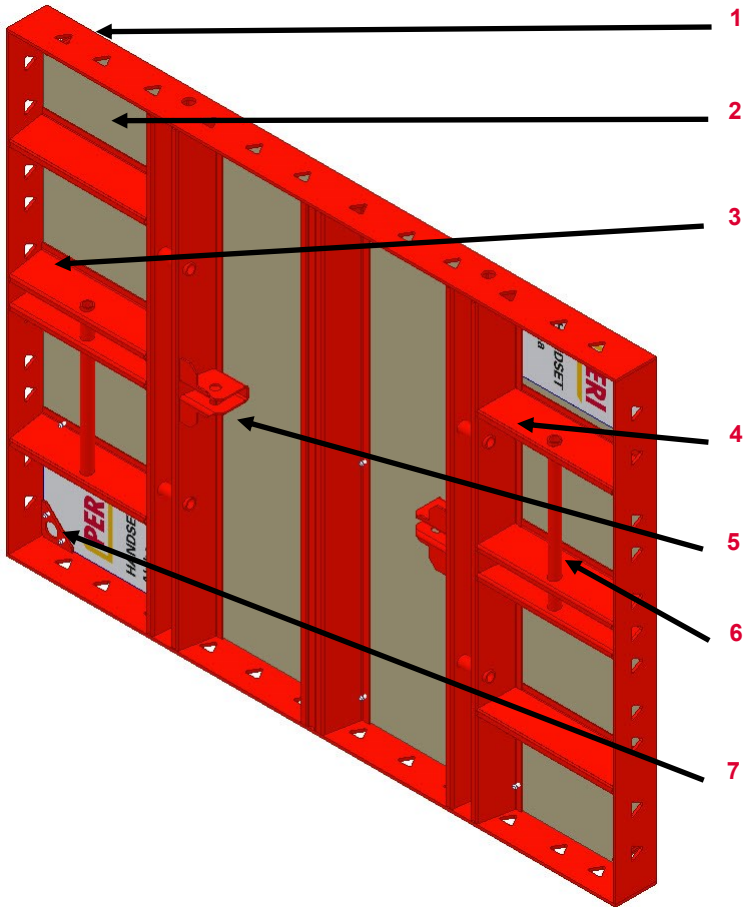











1	Frame
2	Plywood 12 mm
3	Anchor Strut
4	Panel Strut
5	Brace Connector
6	Handle
7	Plywood Support

Valid for	Article Number
Panel HSA 300 x 90	135550
Panel HSA 300 x 60	135574
Panel HSA 300 x 30	135583
Panel HSA 150 x 90	135522
Panel HSA 150 x 60	135558
Panel HSA 150 x 30	135565
Panel HSA 120 x 90	135543
Panel HSA 120 x 60	135569
Panel HSA 120 x 30	135578

PERI Rental Criteria

HANDSET Alpha

















Panel	Description	Instruction	Billing	Type
	<p>Dents in Frame</p> <ul style="list-style-type: none"> ■ If possible ■ Or if not possible 	<p>If possible: </p> <p>Or if not possible: </p>	<p>If possible: </p> <p>Or if not possible: </p>	<p></p> <p></p>
	<p>Connection holes soiled with concrete</p>	<p></p>	<p></p>	<p></p>

PERI Rental Criteria

HANDSET Alpha

















Panel	Description	Instruction	Billing	Type
	Strut bent <ul style="list-style-type: none"> ■ If possible 			
	<ul style="list-style-type: none"> ■ Or if not possible 			
	Brace Connector bent <ul style="list-style-type: none"> ■ If possible 			
	<ul style="list-style-type: none"> ■ Or if not possible 			

PERI Rental Criteria

HANDSET Alpha



Panel	Description	Instruction	Billing	Type
	<p>Handle bent</p> <ul style="list-style-type: none"> ■ If possible ■ Or if not possible ■ Or weld seam cracked 	<ul style="list-style-type: none">    	<ul style="list-style-type: none">    	<ul style="list-style-type: none">   
	<p>Element Bent</p> <ul style="list-style-type: none"> ■ > 8 mm 	<ul style="list-style-type: none">   	<ul style="list-style-type: none">  	<ul style="list-style-type: none"> 

PERI Rental Criteria

HANDSET Alpha



Internal Corner	No.	Name	Article number
-----------------	-----	------	----------------

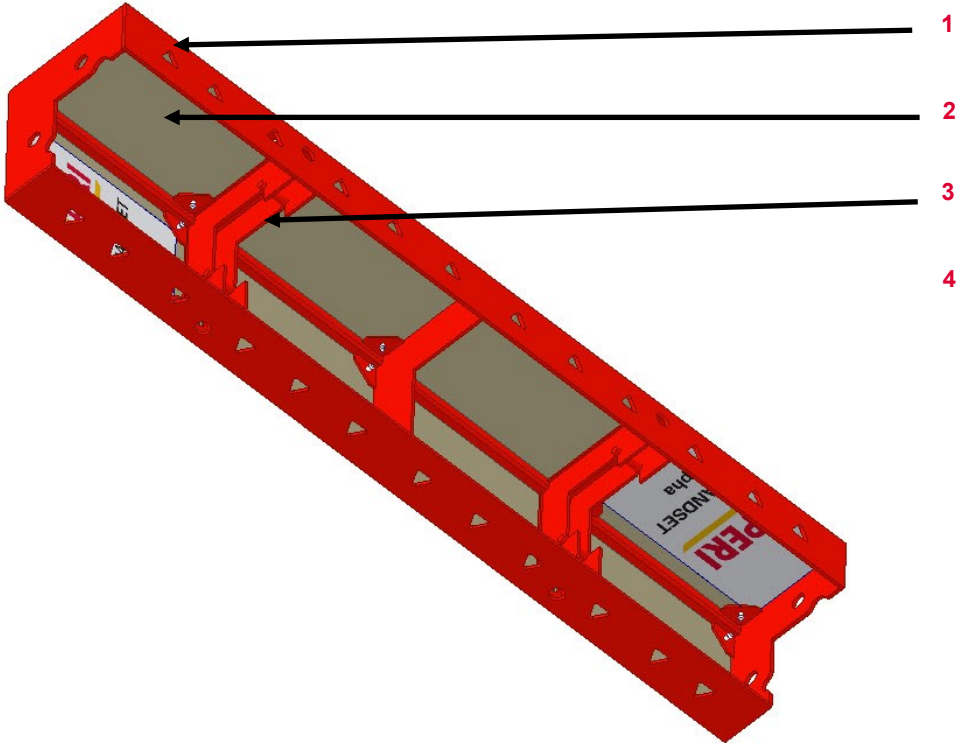











1	Frame
2	Birch Plywood
3	Strut

Valid for	Article Number
Internal Corner HSA 300	135840
Internal Corner HSA 150	135830
Internal Corner HSA 120	135835

PERI Rental Criteria

HANDSET Alpha



Internal Corner	Description	Instruction	Billing	Type
	<p>Dents in Frame</p> <ul style="list-style-type: none"> ■ If possible ■ Or if not possible 	<p>   </p>	<p>   </p>	<p>   </p>
	<p>Connection holes soiled with concrete</p>	<p></p>	<p></p>	<p></p>

PERI Rental Criteria

HANDSET Alpha



Internal Corner	Description	Instruction	Billing	Type
-----------------	-------------	-------------	---------	------

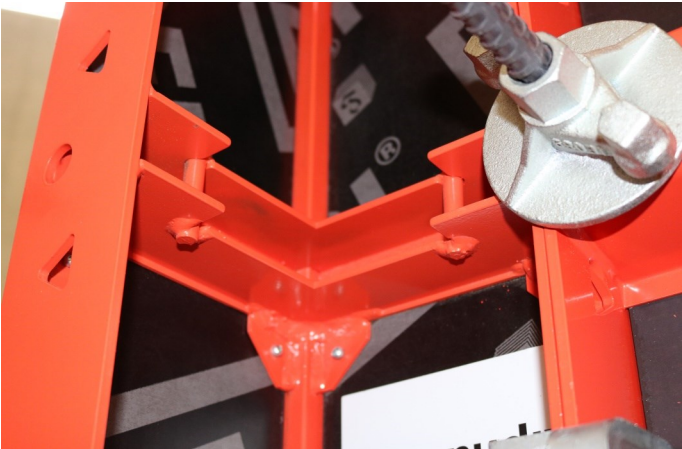

Strut bent

- If possible
- Or if not possible

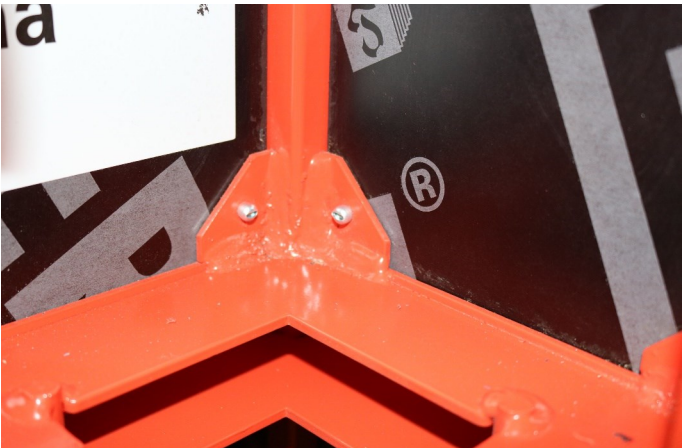

Plywood support bent











- If possible
- Or if not possible

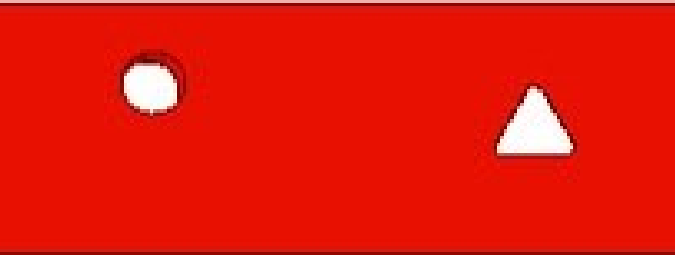

PERI Rental Criteria

HANDSET Alpha







External Corner (135620 135623)	Description	Instruction	Billing	Type
	<p>Bent</p> <ul style="list-style-type: none"> ■ If possible ■ Or if not possible 	<p>   </p>	<p>  088244  </p>	<p>   </p>
	<p>Connection Holes soiled</p>	<p></p>	<p></p>	<p></p>

PERI Rental Criteria

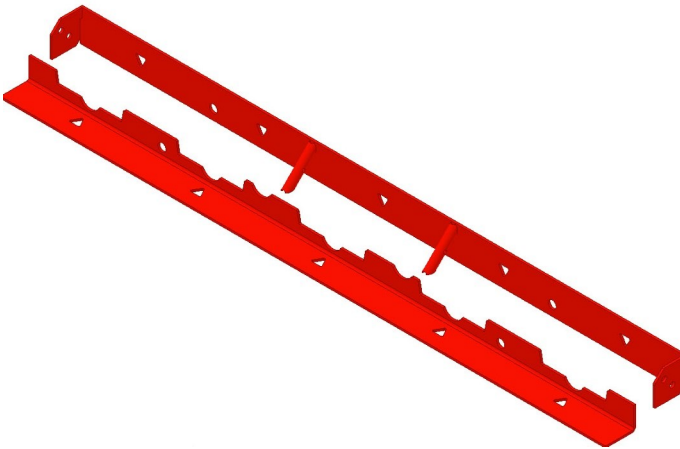
HANDSET Alpha











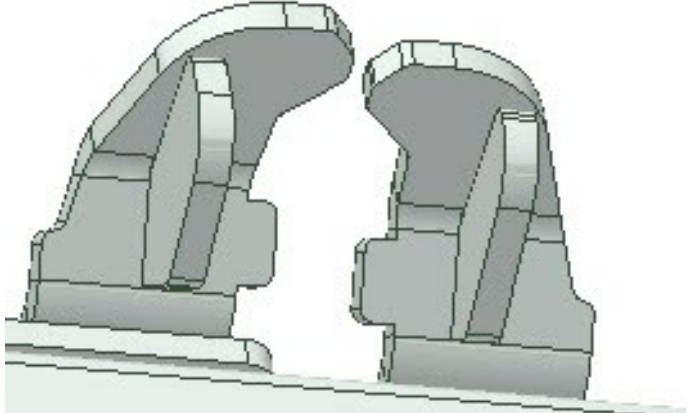

External Corner (135620 135623)	Description	Instruction	Billing	Type
	Seperated			

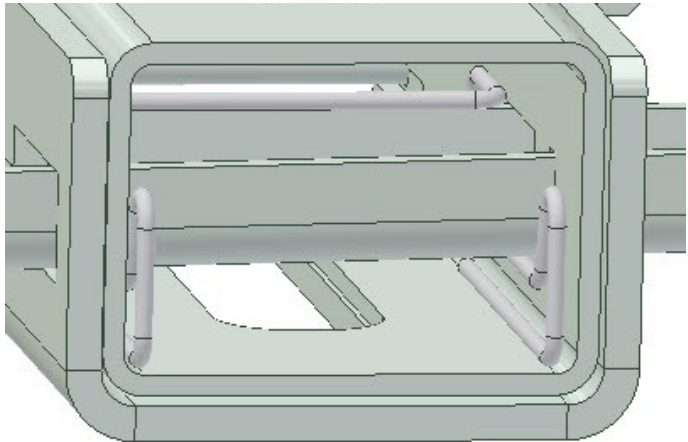
PERI Rental Criteria

HANDSET Alpha



Alignment Clamp HSA (135745)	Description	Instruction	Billing	Type
	Claws bent			
	<ul style="list-style-type: none"> ■ If possible 			
	Spring missing			
	<ul style="list-style-type: none"> ■ Or if not possible 			
				
		135731 (Spring)	089409	

PERI Rental Criteria

HANDSET Alpha



Wedge Clip HSA (135818)	Description	Instruction	Billing	Type
-------------------------	-------------	-------------	---------	------



Bent

- If possible
- Or if not possible



088244



PERI Rental Criteria

HANDSET Alpha



Compensation Clamp HSA (135763)	Description	Instruction	Billing	Type
---------------------------------	-------------	-------------	---------	------

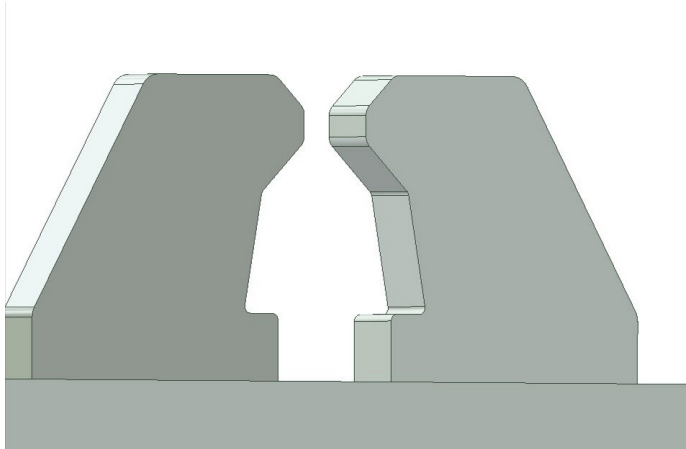

Claws bent

- If possible
- Or if not possible



088244

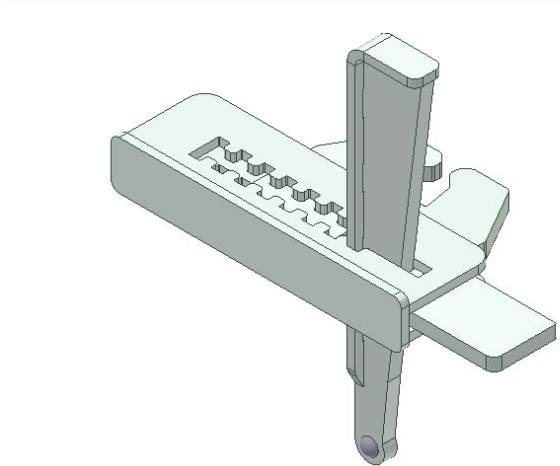

Wedge missing



135749 (Wedge)
107521 (Rivet)













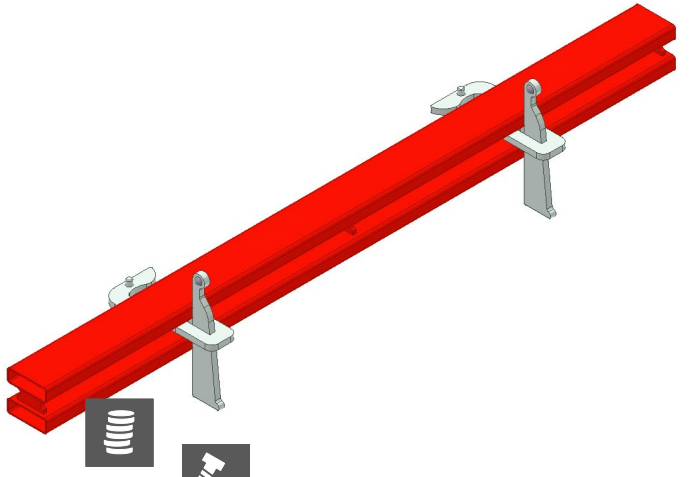

089410

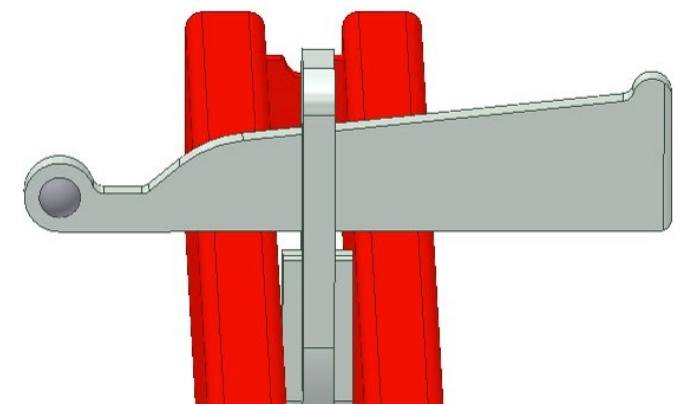

PERI Rental Criteria

HANDSET Alpha



HSA Compensation Waler 95 (135643)	Description	Instruction	Billing	Type
	<p>Bent</p> <ul style="list-style-type: none"> ■ If possible ■ Or if not possible 	<p>   </p>	<p>  088244  </p>	<p>   </p>
	<p>Wedge missing</p>	<p>  135638 (Wedge)  107521 (Rivet) </p>	<p>  </p>	<p>   </p>

PERI Rental Criteria

HANDSET Alpha

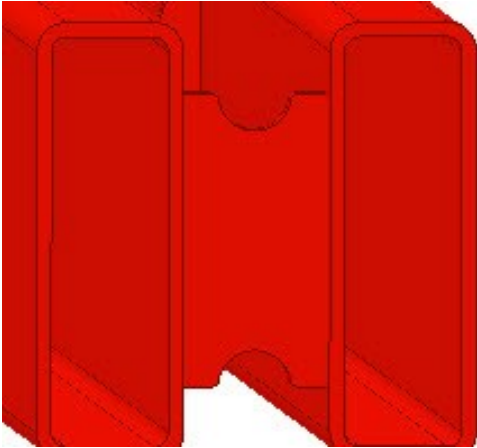

HSA Stopend Waler (135635 135631)	Description	Instruction	Billing	Type
	Dents in tube			
	■ ≤ 3 mm	✓		
	■ Or > 3 mm and bending possible		088244	
	■ Or if bending not possible			
	Spacer missing			

PERI Rental Criteria

HANDSET Alpha



Filler Support (135813 135806 135810)	Description	Instruction	Billing	Type
--	-------------	-------------	---------	------

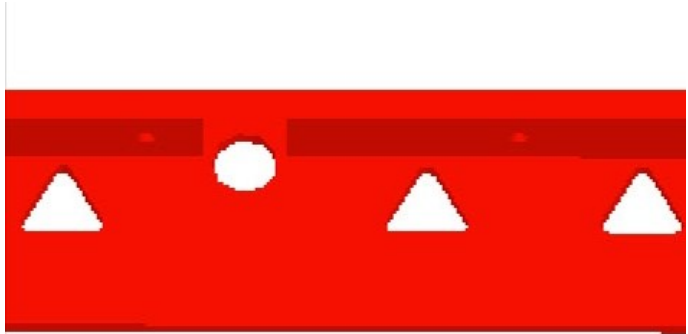

Connection holes soiled

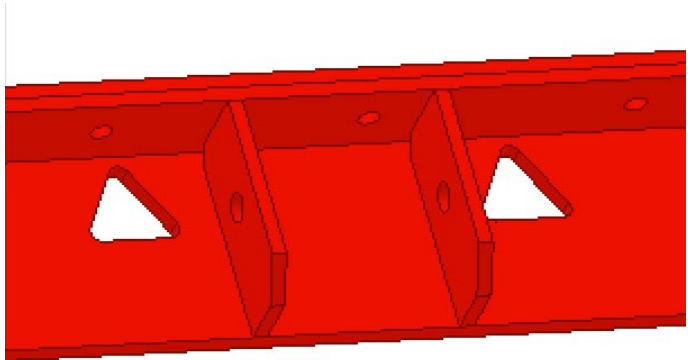

Plates bent

- If possible



088244













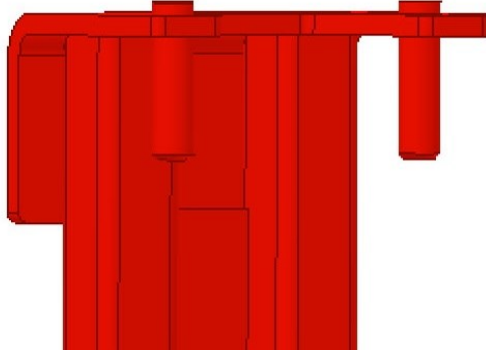









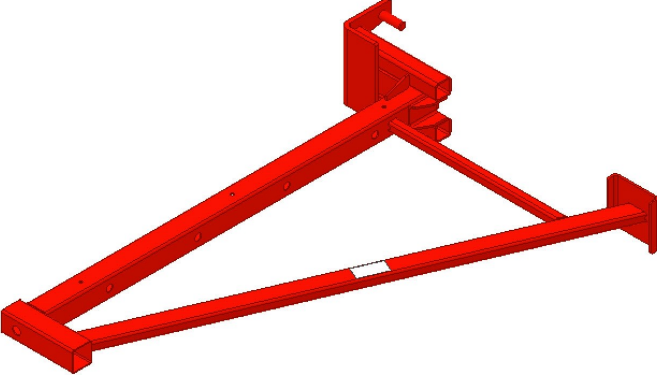

- Or if not possible



PERI Rental Criteria

HANDSET Alpha











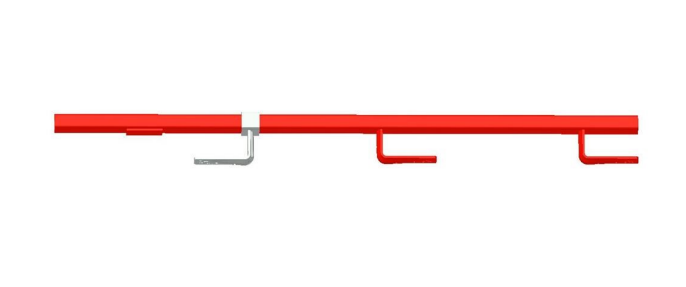

Scaffold Bracket HSA 80 (135907)	Description	Instruction	Billing	Type
	Hooks bent			
	<ul style="list-style-type: none"> ■ If possible 		 088244	
	<ul style="list-style-type: none"> ■ Or if not possible 	 		
	<ul style="list-style-type: none"> ■ Or cracks in material 	 		
	Dents in tube			
	<ul style="list-style-type: none"> ■ ≤ 3 mm 			
	<ul style="list-style-type: none"> ■ Or > 3 mm and bending possible 		 088244	
	<ul style="list-style-type: none"> ■ Or > 3 mm and bending not possible 	 		

PERI Rental Criteria

HANDSET Alpha



Guardrail Post HSGP - 2 (116292)	Description	Instruction	Billing	Type
	<p>Slider deformed missing</p>	<p> 115673 (Slider)</p>	<p> 088227</p>	
	<p>Wedge broken</p>	<p></p>	<p> 088227</p>	
	<p>Bent</p> <ul style="list-style-type: none"> ■ 5 - 10 mm ■ Or > 10 mm 	<p></p> <p></p>	<p></p> <p></p>	<p></p> <p></p>

PERI Rental Criteria

HANDSET Alpha



External Brace Connector (138049)	Description	Instruction	Billing	Type
-----------------------------------	-------------	-------------	---------	------

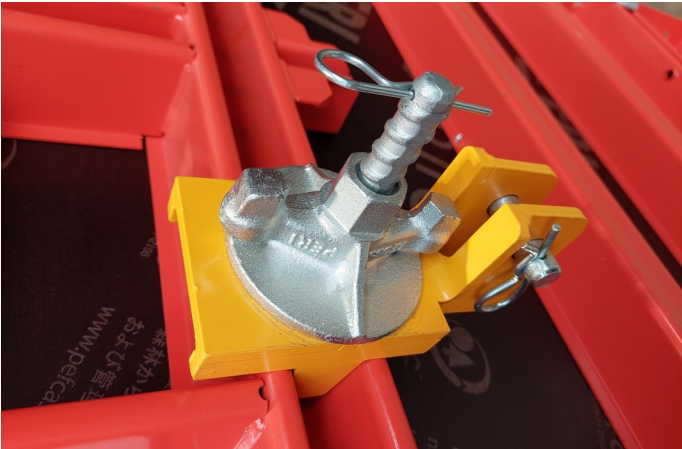

Cam Nut

- Missing
- Or damaged due to force



030110



030110



Brace Connector Hook







- Missing
- Or damaged due to force



PERI Rental Criteria

HANDSET Alpha



















External Brace Connector (138049)	Description	Instruction	Billing	Type
	<p>Pin Cotter Pin</p> <ul style="list-style-type: none"> ■ Missing ■ Or damaged due to force 	<div style="display: flex; flex-direction: column; gap: 10px;"> <div style="display: flex; align-items: center;">  <div style="margin-left: 10px;"> <p>027170 (Pin) 018060 (Cotter Pin)</p> </div> </div> <div style="display: flex; align-items: center;">  </div> </div>	<div style="display: flex; flex-direction: column; gap: 10px;"> <div style="display: flex; align-items: center;">  </div> <div style="display: flex; align-items: center;">  </div> </div>	<div style="display: flex; flex-direction: column; gap: 10px;"> <div style="display: flex; align-items: center;">  </div> <div style="display: flex; align-items: center;">  </div> </div>

PERI Rental Criteria

Glossar Icons



Icon	Significance	Icon	Significance	Icon	Significance
	Not Ok– material is scrap		Billing necessary (customer)		Optical damage
	OK– material stays in rental park		No Billing necessary		Functional damage
	Scrap material– it's not permitted to hand out the material because of safety aspects		Shorten material		Functional damage— it's not permitted to hand out the material
	Repair according to instruction		Mark material		Static damage— it's not permitted to hand out the material
	Fix material cold—Afterwards check weld seams and bordering components		Replace damaged material		
	Repair after local economic efficiency calculation		Replace missing material		
	Clean material				