

# PERI Rental Criteria

## GRIDFLEX slab formwork

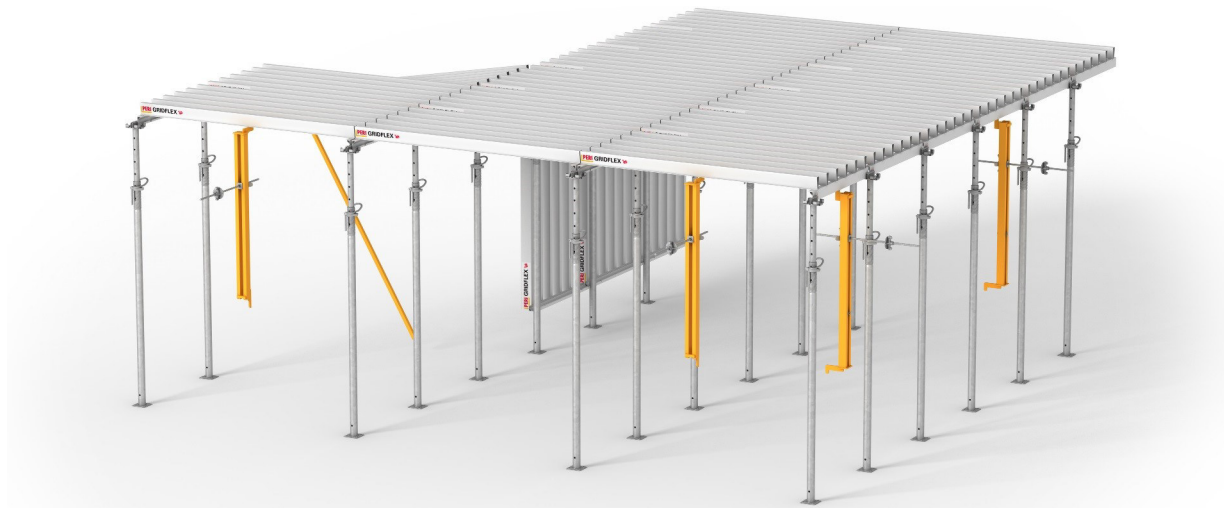

### Contact

**PERI GmbH**  
**Formwork Scaffolding**  
**Engineering**

P.O. Box 1264  
 89264 Weißenhorn; Germany  
 Phone +49 (0) 7309.950-0  
 Fax +49 (0) 7309.951-0  
[rental-criteria@peri.de](mailto:rental-criteria@peri.de)

Content	Page	Changes made	Date   Initial	page
Panels	2	New version	02/2017   fw	
Guardrail GF 100	7			
Traverse GFT 100	9			
Prophead	10			
Wall Holder	11			
Clamp	12			
Anchor Chain	13			
Head Spindle	16			
Stacking Device	17			

# PERI Rental Criteria

## GRIDFLEX slab formwork



Panels	No.	Description	Article number
--------	-----	-------------	----------------

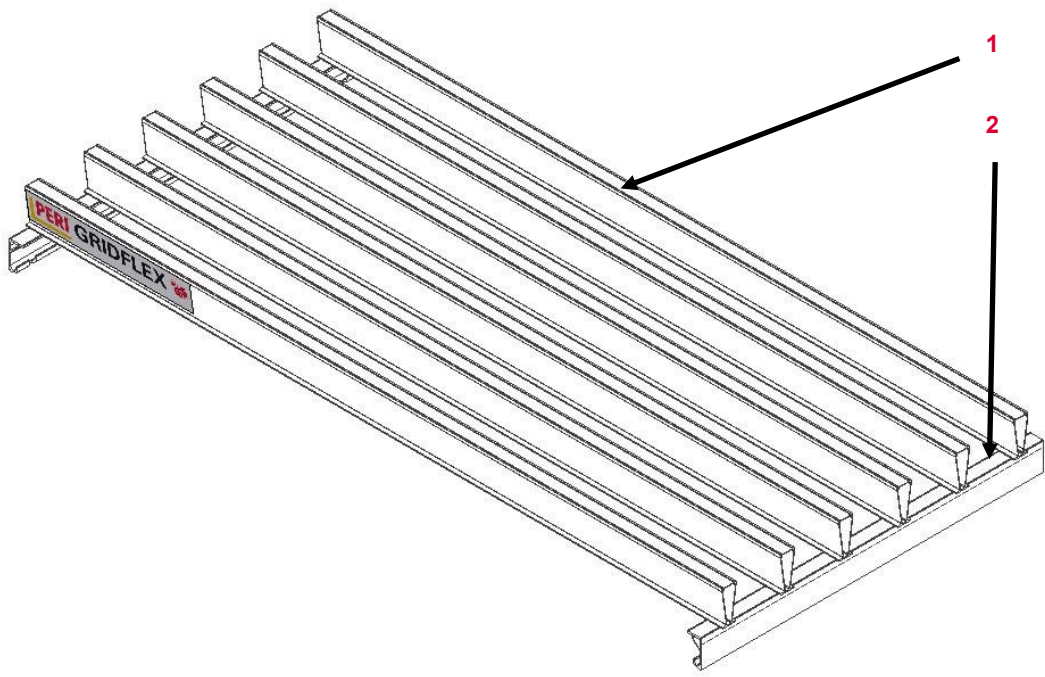











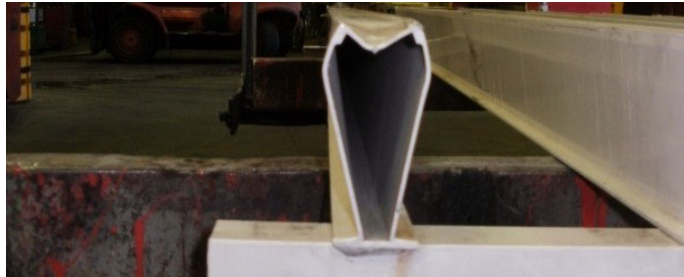

1	Length profile
2	Horizontal profile

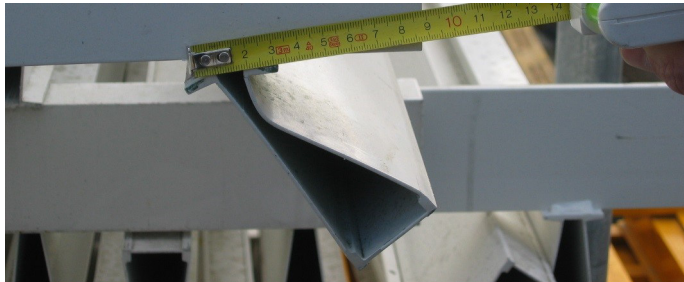
Valid for	Article number
Standard Element GFP 200 x 100	110038
Filler Element Cross GFC 200 x 100	110040
Filler Element Longitudinal GFL 150 x 100	110486
Filler Element Longitudinal GFL 183 x 20	110646

# PERI Rental Criteria

## GRIDFLEX slab formwork













Panels	Description	Instruction	Billing Condition	Type
	<p>18.01 End of length profile bent</p>		 See table p. 6	
	<p>18.02 Length profile bent completely</p>		 See table p. 6	
	<p>18.03 Length profile cut in   torn out</p>		 See table p. 6	

# PERI Rental Criteria

## GRIDFLEX slab formwork





Panels	Description	Instruction	Billing Condition	Type
 <p>31.01.2007 12:36</p>	<b>18.04 Horizontal profile cut in</b>	 		
 <p>31.01.2007 12:33</p>	<b>18.05 Crack in welding</b>			
	<ul style="list-style-type: none"> <li>■ Without deformation</li> <li>■ Or with deformation</li> </ul>	  	  	  088273

# PERI Rental Criteria

## GRIDFLEX slab formwork



Panels	Description	Instruction	Billing Condition	Type
	<b>18.06 Nail holes</b>			
	<ul style="list-style-type: none"> <li>■ &gt; 75 % of the profile remaining</li> <li>■ ≤ 75 % of the profile remaining</li> </ul>	<ul style="list-style-type: none"> <li></li> <li></li> </ul>	<ul style="list-style-type: none"> <li></li> <li></li> </ul>	<ul style="list-style-type: none"> <li></li> <li></li> </ul>
	<b>18.07 Panel bent diagonally</b>			
	<ul style="list-style-type: none"> <li>■ ≤ 40 mm</li> <li>■ Or &gt; 40 mm</li> </ul>	<ul style="list-style-type: none"> <li></li> <li></li> </ul>	<ul style="list-style-type: none"> <li> 088244</li> <li></li> </ul>	<ul style="list-style-type: none"> <li></li> <li></li> </ul>

# PERI Rental Criteria

## GRIDFLEX slab formwork

















Article	Article number	Service Article number
Brace 1994	110678	088396
Brace 1850	110688	088397
Brace 1830	110913	088399
Brace 1507	110684	088398



# PERI Rental Criteria

## GRIDFLEX slab formwork









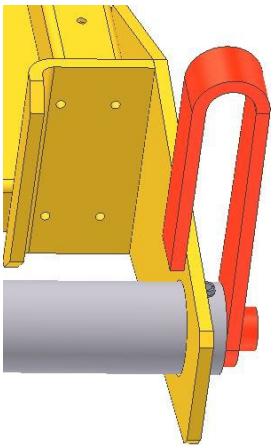

Guardrail GF 100 (110326)	Description	Instruction	Billing Condition	Type
	<p><b>18.08 Connection bent</b></p> <ul style="list-style-type: none"> <li>■ If possible</li> <li>■ Or if not possible</li> </ul>	<ul style="list-style-type: none"> <li>  </li> <li>  </li> </ul>	<ul style="list-style-type: none"> <li>  </li> <li>  </li> </ul>	<ul style="list-style-type: none"> <li>  </li> <li>  </li> </ul>
	<p><b>18.09 Braces bent</b></p> <ul style="list-style-type: none"> <li>■ If possible</li> <li>■ Or if not possible</li> </ul>	<ul style="list-style-type: none"> <li>  </li> <li>  </li> </ul>	<ul style="list-style-type: none"> <li>  </li> <li>  </li> </ul>	<ul style="list-style-type: none"> <li>  </li> <li>  </li> </ul>

# PERI Rental Criteria

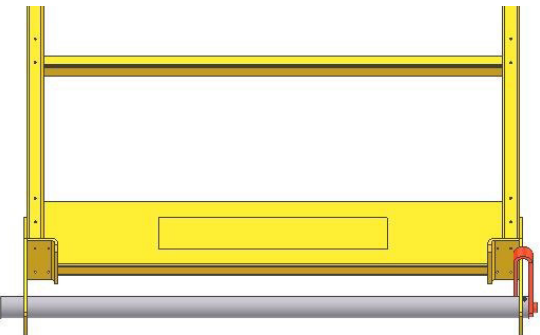
## GRIDFLEX slab formwork













Guardrail GF 100 (110326)	Description	Instruction	Billing Condition	Type
	<p><b>18.10 Lever bent</b></p>	 110821 (Lever)		
	<p><b>18.11 Tube bent</b></p>	 110415 (tube)		

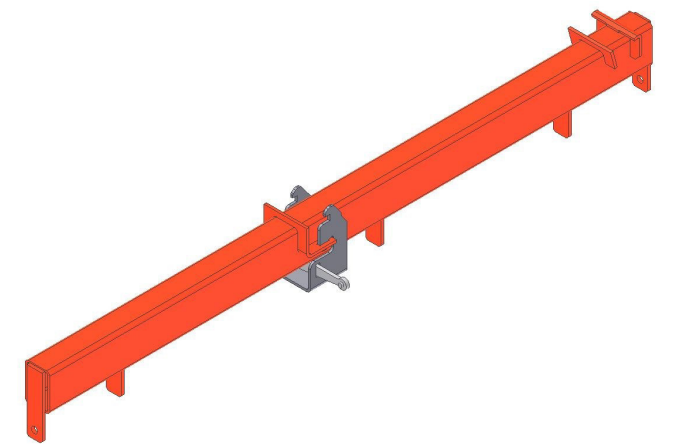

# PERI Rental Criteria

## GRIDFLEX slab formwork



Traverse GFT 100 (110045)	Description	Instruction	Billing Condition	Type
	<p><b>18.12 Plaids bent</b></p> <ul style="list-style-type: none"> <li>■ If possible</li> <li>■ Or if not possible</li> </ul>	<ul style="list-style-type: none"> <li></li> <li></li> </ul>	<ul style="list-style-type: none"> <li></li> <li></li> </ul>	<ul style="list-style-type: none"> <li></li> <li></li> </ul>
	<p><b>18.13 Traverse bent   kink</b></p>	<ul style="list-style-type: none"> <li></li> <li></li> </ul>	<ul style="list-style-type: none"> <li></li> </ul>	<ul style="list-style-type: none"> <li></li> </ul>

# PERI Rental Criteria

## GRIDFLEX slab formwork











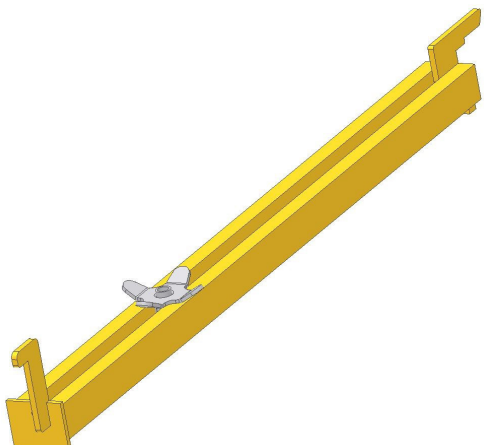



Prophead GFH (109910)	Description	Instruction	Billing Condition	Type
	<p><b>18.14 Prophead bent</b></p>			
	<p><b>18.15 Spring</b></p> <ul style="list-style-type: none"> <li>■ Bent</li> <li>■ Or missing</li> </ul>	<ul style="list-style-type: none"> <li> 110167</li> <li> 110167</li> </ul>	<ul style="list-style-type: none"> <li> 110167</li> <li> 110167</li> </ul>	<ul style="list-style-type: none"> <li> 110167</li> <li> 110167</li> </ul>

# PERI Rental Criteria

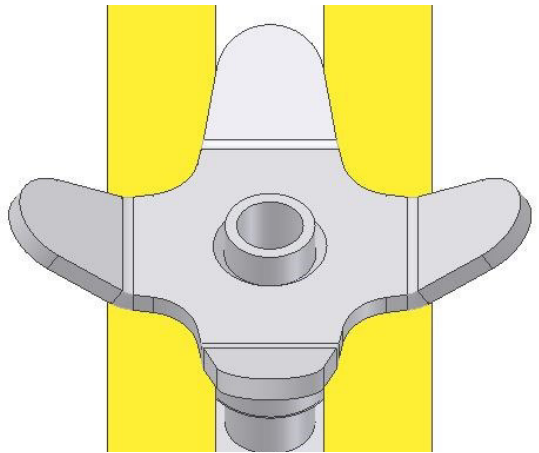
## GRIDFLEX slab formwork











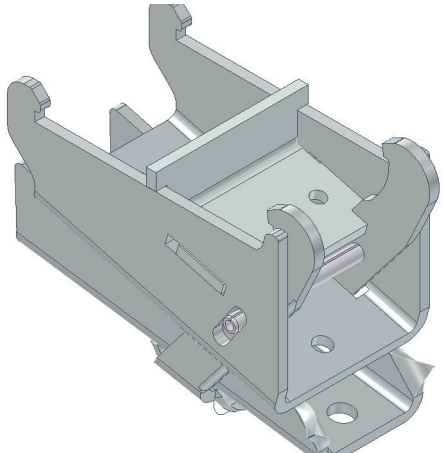

Wall holder GFW (110238)	Description	Instruction	Billing Condition	Type
	<p><b>18.16 Wall holder bent</b></p> <ul style="list-style-type: none"> <li>■ If possible</li> <li>■ Or if not possible</li> </ul>	<p>If possible: </p> <p>Or if not possible:  </p>	<p>If possible: </p> <p>Or if not possible: </p>	<p>If possible: </p> <p>Or if not possible: </p>
	<p><b>18.17 Star grip nut useless</b></p>	<p> </p>	<p></p>	<p></p>

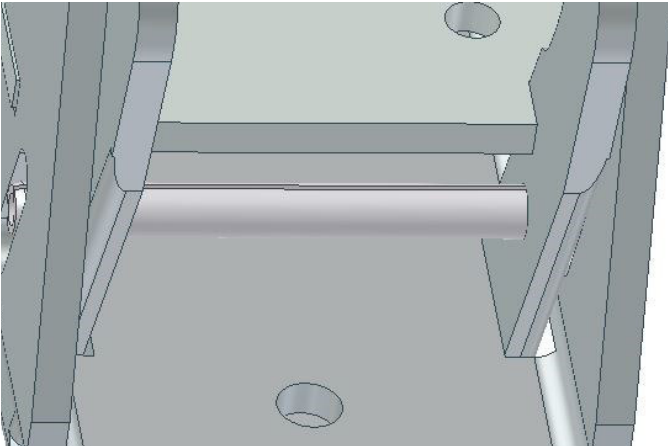
# PERI Rental Criteria

## GRIDFLEX slab formwork



Clamp GFK (110556)	Description	Instruction	Billing Condition	Type
	<b>18.18 Dent   Deformed</b>			
	<ul style="list-style-type: none"> <li>■ If possible</li> </ul>			
	<b>18.19 Sleeve</b>			
	<ul style="list-style-type: none"> <li>■ Bent</li> </ul>	 117286 (Sleeve)		
	<ul style="list-style-type: none"> <li>■ Or missing</li> </ul>	 117286 (Sleeve)		

# PERI Rental Criteria

## GRIDFLEX slab formwork



Anchor Chain (065073)	Description	Instruction	Billing Condition	Type
-----------------------	-------------	-------------	-------------------	------



18.20 Chain link bent

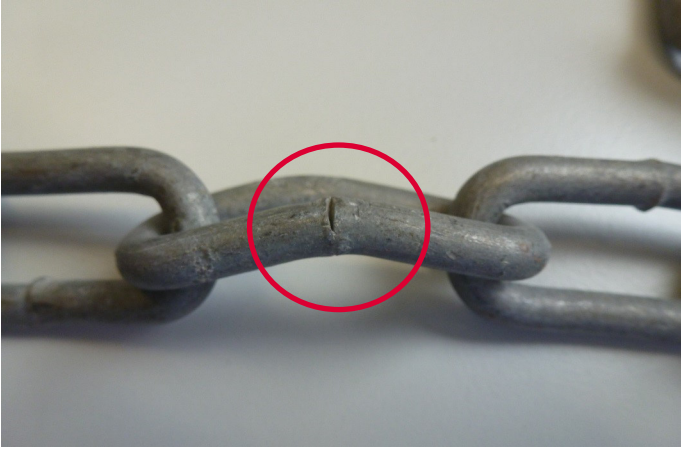











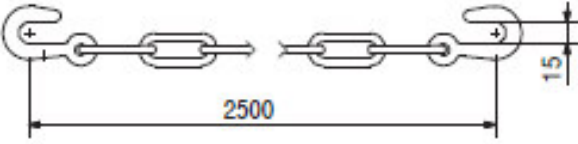



18.21 Chain link broken



# PERI Rental Criteria

## GRIDFLEX slab formwork



Anchor Chain (065073)	Description	Instruction	Billing Condition	Type
	<p><b>18.22 Measurement</b></p> <ul style="list-style-type: none"> <li>■ &gt; 257,0 cm</li> <li>■ Or &lt; 247,5 cm</li> </ul>	<ul style="list-style-type: none"> <li>■ &gt; 257,0 cm:  </li> <li>■ Or &lt; 247,5 cm:  </li> </ul>	<ul style="list-style-type: none"> <li>■ &gt; 257,0 cm: </li> <li>■ Or &lt; 247,5 cm: </li> </ul>	<ul style="list-style-type: none"> <li>■ &gt; 257,0 cm: </li> <li>■ Or &lt; 247,5 cm: </li> </ul>
	<p><b>18.23 Rusty chain</b></p>	<ul style="list-style-type: none"> <li>■ Rusty chain:  </li> </ul>	<ul style="list-style-type: none"> <li>■ Rusty chain: </li> </ul>	<ul style="list-style-type: none"> <li>■ Rusty chain: </li> </ul>



# PERI Rental Criteria

## GRIDFLEX slab formwork



Anchor Chain (065073)	Description	Instruction	Billing Condition	Type
-----------------------	-------------	-------------	-------------------	------



18.24 Stretched chain link



18.25 Hook bent | cracked











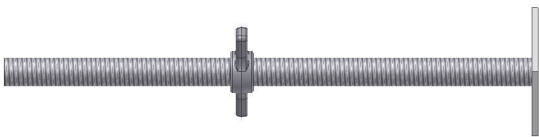



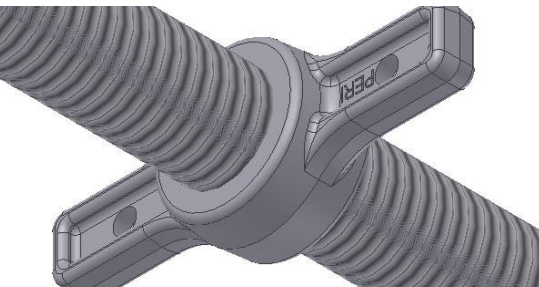







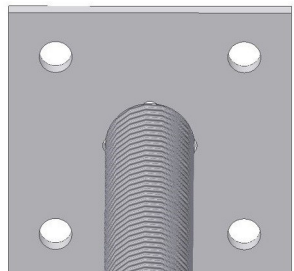

# PERI Rental Criteria

## GRIDFLEX slab formwork











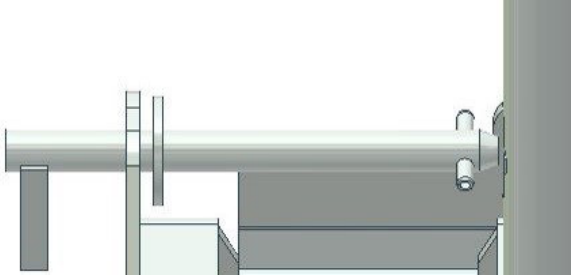





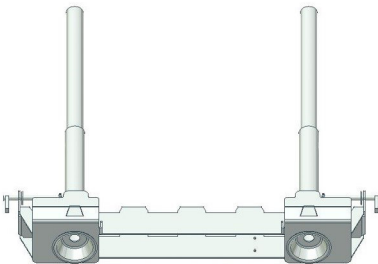

Head Spindle GTR (111291)	Description	Instruction	Billing Condition	Type
	<b>18.26 Spindle</b>			
	<ul style="list-style-type: none"> <li>■ Thread not moveable</li> </ul>	 		
	<ul style="list-style-type: none"> <li>■ Or spindle bent</li> </ul>	 		
	<b>18.27 Clamp nut broken</b>	 		
	<b>18.28 Plaid bent</b>			
	<ul style="list-style-type: none"> <li>■ If possible</li> </ul>			
<ul style="list-style-type: none"> <li>■ Or if not possible</li> </ul>	 			

# PERI Rental Criteria

## GRIDFLEX slab formwork



















Stacking Device GRIDFLEX (110939)	Description	Instruction	Billing Condition	Type
	<p><b>18.29 Safety lever missing</b></p>	 110936 (Safety lever) 108195 (Sleeve)		
	<p><b>18.30 Extension</b></p> <ul style="list-style-type: none"> <li>■ Missing</li> <li>■ Or damaged by force</li> </ul>	 111392   111392	  	  
	<p><b>18.31 Device bent</b></p> <ul style="list-style-type: none"> <li>■ If possible</li> <li>■ Or if not possible</li> </ul>	  	  	  

# PERI Rental Criteria

## Glossar Icons



Icon	Significance	Icon	Significance	Icon	Significance
	Not OK – material is scrap		Billing necessary (customer)		Optical damage
	OK—material stays in rental park		No Billing necessary		Functional damage
	Scrap material—it's not permitted to hand out the material because of safety aspects		Shorten material		Functional damage—it's not permitted to hand out the material
	Repair according to Instruction		Mark material		Static damage—it's not permitted to hand out the material
	Fix material cold– Afterwards check weld seams and bordering components		Replace damaged material		
	Repair after local economic efficiency calculation		Replace missing material		
	Clean material				