

# PERI Rental Criteria

## ACS 100

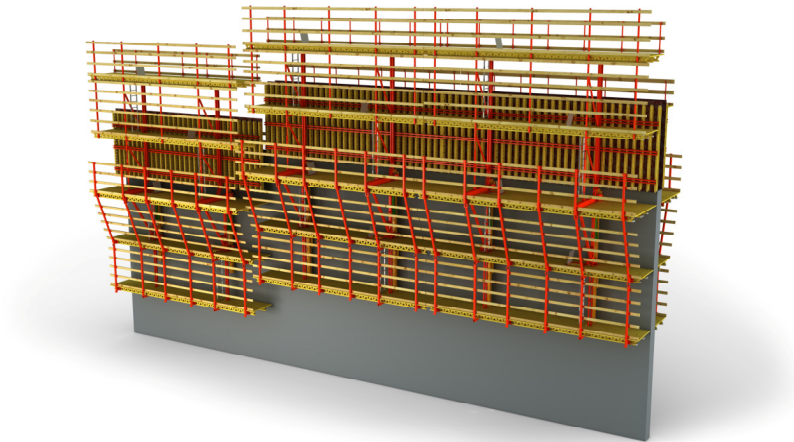

### Contact

**PERI GmbH**  
**Formwork Scaffolding**  
**Engineering**  
 P.O. Box 1264  
 89264 Weissenhorn, Germany  
 Phone +49 (0) 7309.950-0  
 Fax +49 (0) 7309.951-0  
 rental-criteria@peri.de

Content	Page
Hydraulic Pump	2
Hydraulic Climbing Mechanism	9
Remote Control ACS	17
Hydraulic hoses	19
Climbing Rail ACS	23
Main Platform Beam	27
Climbing Shoe	39
Accessories	43
Glossary	106

Changes made	Date   Initial	Page
New Version	07/2018   fw	

# PERI Rental Criteria

## ACS 100



### Hydraulic Pumps ACS

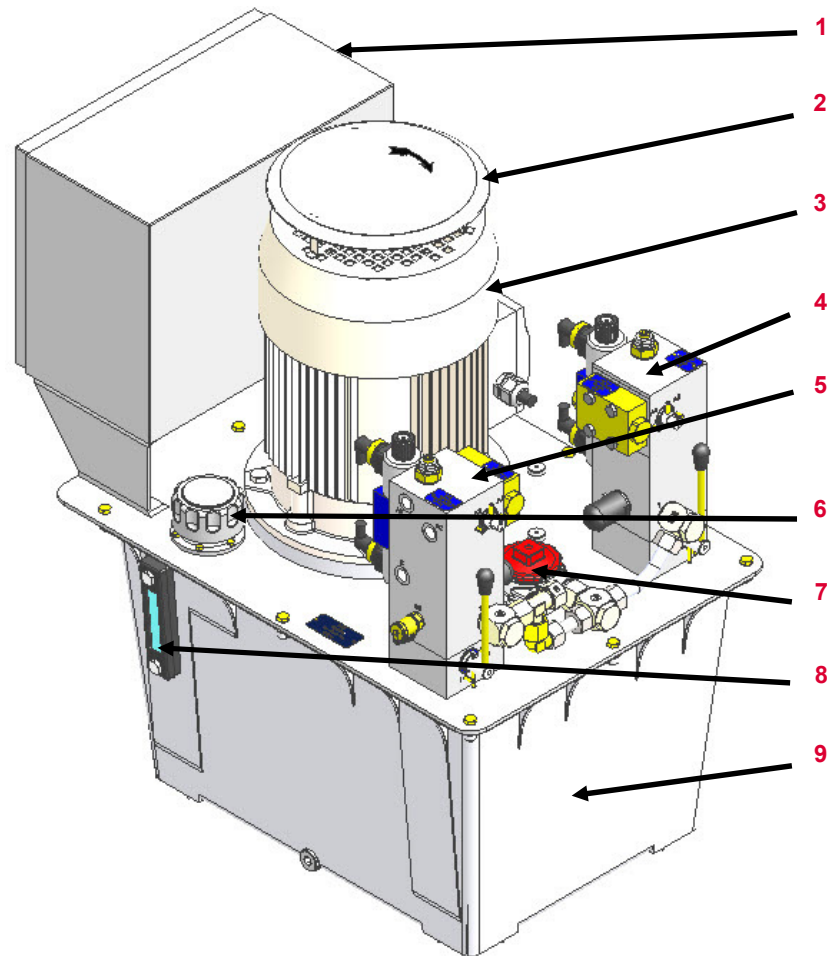

No.	Name	Tries– Article Number
1	Electronic Controller	
2	Motor Cover	
3	Three Phases Electronic Motor	
4	Valve Block left	964.003.001.000
5	Valve Block right	964.003.002.000
6	Filler Breather	K016.087
7	Return Filter	K017.006
8	Oil Level Indicator	K016.069
9	Reservoir	K016.103

# PERI Rental Criteria

## ACS 100

















Article	Article Number
Hydraulic Pump ACS 1 x 210/400- 460V	057357
Hydraulic Pump ACS 2 x 210/400V	051739
Hydraulic Pump ACS 2 x 210/460V	051762
Hydraulic Pump ACS 2 x 240/400V	057637
Hydraulic Pump ACS 2 x 240/460V	057638
Hydraulic Pump ACS 2 x 240/460V CSA	057766
Hydraulic Pump ACS 4 x 210/400V	051740
Hydraulic Pump ACS 4 x 210/460V	051741
Hydraulic Pump ACS 4 x 240/400V	057639
Hydraulic Pump ACS 4 x 240/460V	057363
Hydraulic Pump ACS 4 x 240/460V CSA	057767

Article	Article number
Hydraulic Pump ACS 6 x 210/400V	051742
Hydraulic Pump ACS 6 x 210/460V	057743
Hydraulic Pump ACS 6 x 240/400V	057641
Hydraulic Pump ACS 6 x 240/460V	057642
Hydraulic Pump ACS 6 x 240/460V CSA	057768
Hydraulic Pump ACS 8 x 210/400V	051746
Hydraulic Pump ACS 8 x 210/460V	051474
Hydraulic Pump ACS 8 x 240/400V	057518
Hydraulic Pump ACS 8 x 240/460V	057643
Hydraulic Pump ACS 8 x 240/460V CSA	057769

# PERI Rental Criteria

## ACS 100



Hydraulic Pump	Description	Instruction	Billing Condition	Type
	<p><b>13.10.01 Motor cover bent</b></p> <ul style="list-style-type: none"> <li>■ If possible</li> <li>■ Or not possible</li> <li>■ Or missing</li> </ul>	<ul style="list-style-type: none"> <li></li> <li></li> <li></li> </ul>	<ul style="list-style-type: none"> <li></li> <li></li> <li></li> </ul>	<ul style="list-style-type: none"> <li></li> <li></li> <li></li> </ul>
	<p><b>13.10.02 Plug damaged</b></p>			

# PERI Rental Criteria

## ACS 100



Hydraulic Pump	Description	Instruction	Billing Condition	Type
----------------	-------------	-------------	-------------------	------



**13.10.03 Oil Level Indicator**

- Missing
  
- Or damaged



Afterwards check oil and reservoir for dirt. Vent the system. if needed change oil and clean the reservoir



**13.10.04 Filler Breather missing**



Afterwards check oil and reservoir for dirt. Vent the system. if needed change oil and clean the reservoir



# PERI Rental Criteria

## ACS 100



Hydraulic Pump	Description	Instruction	Billing Condition	Type
----------------	-------------	-------------	-------------------	------



13.10.05 Electronic damages



13.10.06 Plugs at valve blocks missing











057091 (Threaded Plug)  
 Afterwards check oil and reservoir for dirt. Vent the system. if needed change oil and clean the reservoir



# PERI Rental Criteria

## ACS 100



Hydraulic Pump	Description	Instruction	Billing Condition	Type
	<p><b>13.10.07 Reservoir damaged</b></p> <ul style="list-style-type: none"> <li>■ Reservoir leaking</li> </ul>	<p>Afterwards vent the system</p> 		
	<p><b>13.10.08 Control Cabinet damaged</b></p> <ul style="list-style-type: none"> <li>■ Function not given</li> </ul>	 		

# PERI Rental Criteria

## ACS 100



Hydraulic Pump	Description	Instruction	Billing Condition	Type
----------------	-------------	-------------	-------------------	------

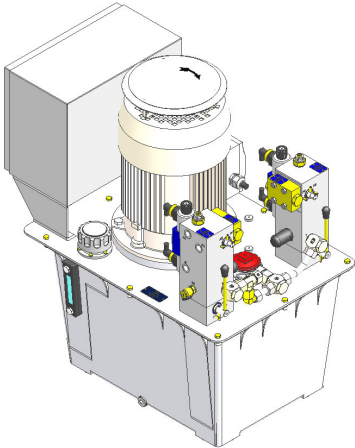

**13.10.09 Function of Pump not given**

- Because of weariness



- Or damaged due to force



**13.10.10 Leaking Hydraulic lines or Fittings**

- Because of weariness



- Or damaged due to force





# PERI Rental Criteria

## ACS 100



### Hydraulic Climbing Mechanism ACS 100 (051738)

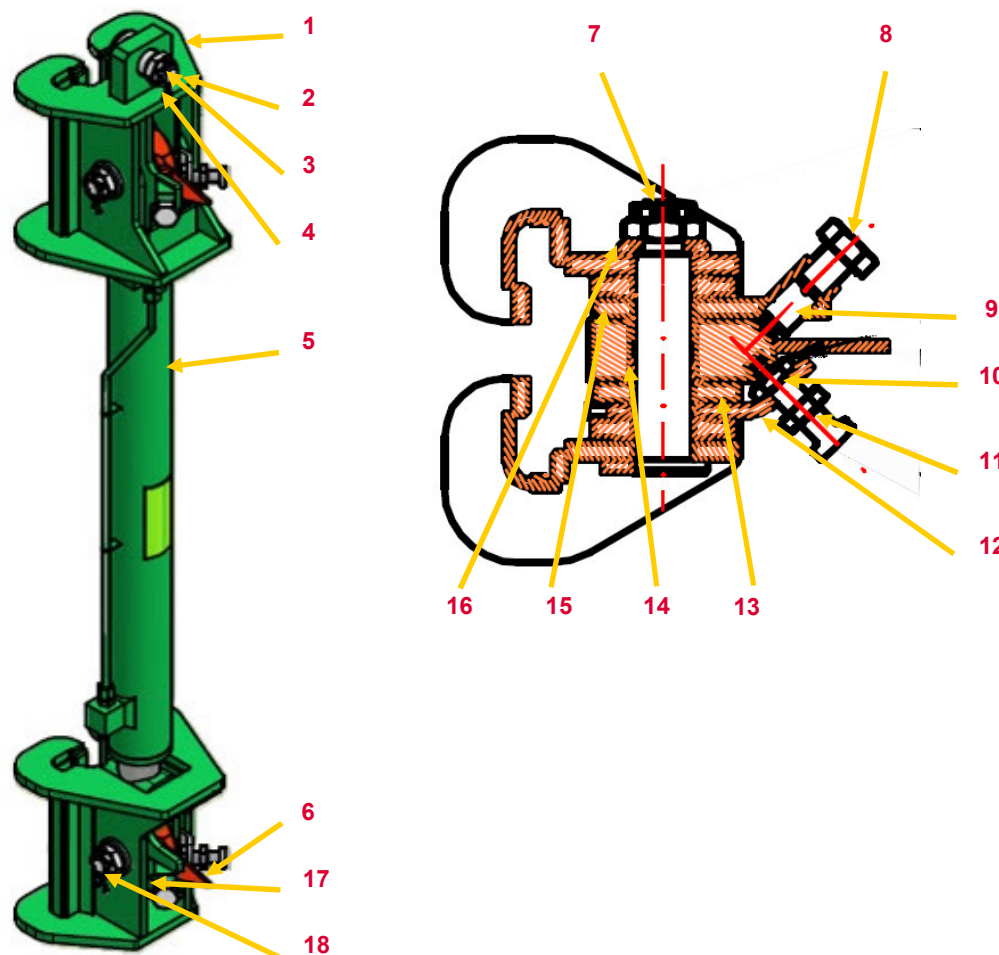

No.	Name	Article Number
1	Upper Climbing Head	706485
2	Head Bolt 40x75	706468
3	Castle Nut M 30	706476
4	Splint 6,3x60	706475
5	Cylinder	706485
6	Pawl	706664
7	Axle 40x174 ACS	706479
8	Bolt M 24x30	706480
9	Spring- Thrust Piece	706481
10	Nut M20x1,5	706469
11	Adjusting Screw	706482
12	Cam	706471
13	DU- Flange 40x44x53x10	706472
14	DU- Flange BB4016DU	706473
15	DU- Thrust Washer WC40DU	706474
16	Strain Washer ACS	706477
17	Lower Climbing Head	706483
18	Axle 40x145	706478

# PERI Rental Criteria

## ACS 100



Hydraulic Climbing Mechanism	Description	Instruction	Billing Condition	Type
------------------------------	-------------	-------------	-------------------	------



### 13.10.11 Scratches at the cylinder

- If possible
  
- Or if not possible



Change by qualified person  
 109.080B.03.000 (Cylinder rod)  
 K030.095 (Sealing)  
 K023.137 (Wiper)  
 Afterwards vent the system



### 13.10.12 Missing Plugs



057091 (Plugs)  
 057376 (Oil)



# PERI Rental Criteria

## ACS 100



Hydraulic Climbing Mechanism	Description	Instruction	Billing Condition	Type
------------------------------	-------------	-------------	-------------------	------



**13.10.13 Bent or broken return line housing**



109.080A.00.009 TRIES  
(Return Line Housing)



**13.10.14 Damaged or broken return line**



109.080B.00.006 TRIES (Tube)  
K018.109 TRIES (Fitting)  
K018.110 (Fitting A3C)



# PERI Rental Criteria

## ACS 100



Hydraulic Climbing Mechanism	Description	Instruction	Billing Condition	Type
------------------------------	-------------	-------------	-------------------	------

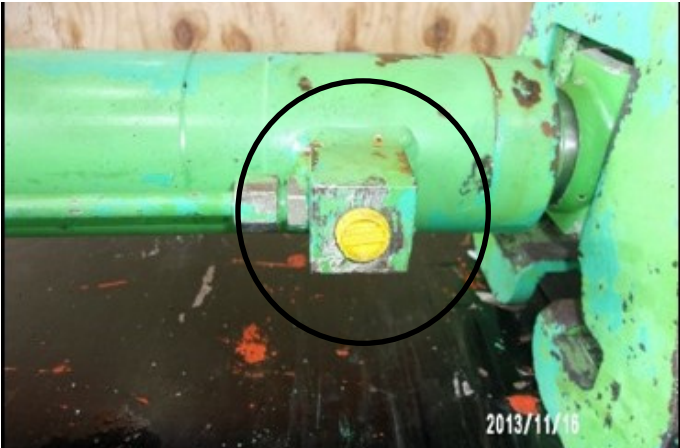

13.10.15 Housing Block damaged



















13.10.16 Head Bolt |  
Castle Nut missing



706476 (Castle nut M 30)  
706475 (Splint 6,3 x 30)  
706468 (Head Bolt 40 x 75)

















Hydraulic Climbing Mechanism	Description	Instruction	Billing Condition	Type
	<b>13.10.17 Spring- Thrust Piece</b>	<ul style="list-style-type: none"> <li>■ Missing  706481 (Spring- Thrust Piece) Clean the thread before assembly</li> </ul>		
	<ul style="list-style-type: none"> <li>■ Or function not given (smooth running of cam and pawl)</li> </ul>	<ul style="list-style-type: none"> <li> 706481 (Spring- Thrust Piece) Clean the thread before assembly</li> </ul>		
	<b>13.10.18 Adjusting Screw</b>	<ul style="list-style-type: none"> <li>■ Missing  706482 (Adjusting Screw) 706469 (Nut)</li> </ul>		
	<ul style="list-style-type: none"> <li>■ Or damaged</li> </ul>	<ul style="list-style-type: none"> <li> 706482 (Adjusting Screw) 706469 (Nut)</li> </ul>		
	<ul style="list-style-type: none"> <li>■ Or function not given (smooth running of cam and pawl)</li> </ul>	<ul style="list-style-type: none"> <li> 706482 (Adjusting Screw) 706469 (Nut)</li> </ul>		

# PERI Rental Criteria

## ACS 100



Hydraulic Climbing Mechanism	Description	Instruction	Billing Condition	Type
	<p><b>13.10.19 Index notch worn</b></p> <ul style="list-style-type: none"> <li>■ Abrasion &gt; 1 mm</li> </ul>	 706664 (Pawl)		
	<p><b>13.10.20 Pawl worn</b></p> <ul style="list-style-type: none"> <li>■ Function given</li> <li>■ Or not given</li> <li>■ Or abrasion &gt; 1 mm at one side (Check crowning of the pawl)</li> </ul>	  706664 (Pawl)  706664 (Pawl)	  	  

# PERI Rental Criteria

## ACS 100



Hydraulic Climbing Mechanism	Description	Instruction	Billing Condition	Type
------------------------------	-------------	-------------	-------------------	------

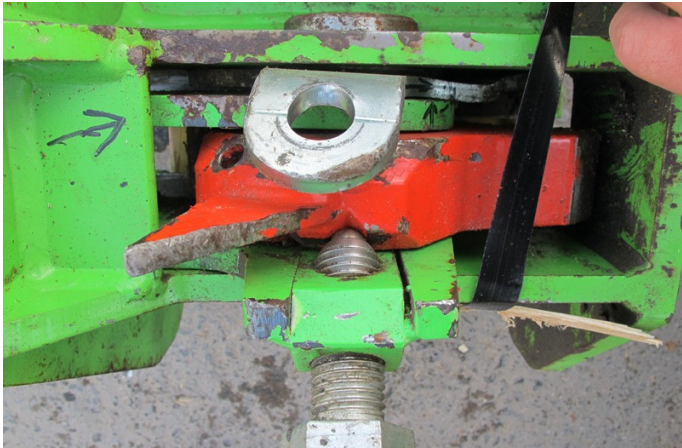

13.10.21 Cam bent



706471 (Cam)



13.10.22 Top of cam worn

■ Top round



■ Or straight area at the top



706471 (Cam)



# PERI Rental Criteria

## ACS 100



Hydraulic Climbing Mechanism	Description	Instruction	Billing Condition	Type
------------------------------	-------------	-------------	-------------------	------



### 13.10.23 Climbing head worn (Test with measuring template)

- Measuring template don't pass through
- Or measuring template passes through



### 13.10.24 Marking lug of the pawl

- Bent
- Or damages due to force (Hits with hammer)





# PERI Rental Criteria

## ACS 100



### Remote Control ACS

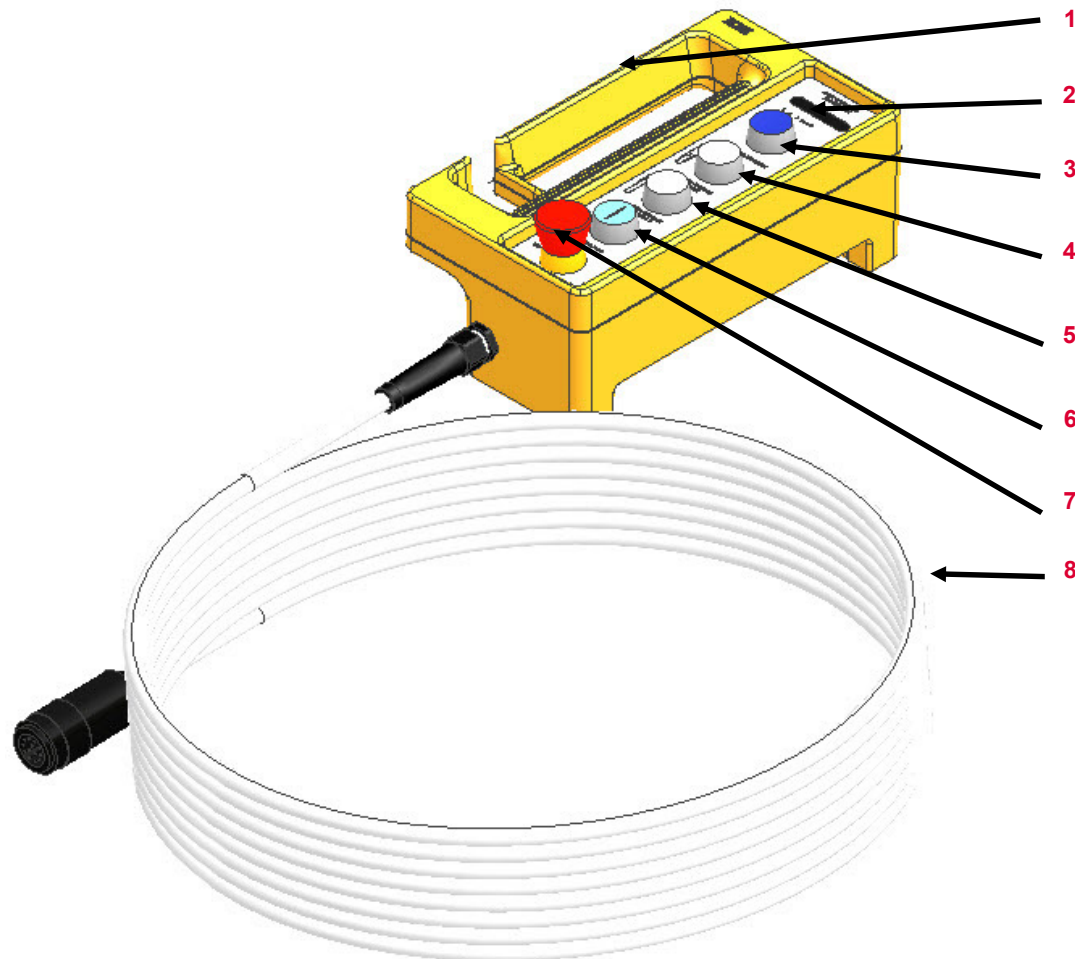

No.	Name	Article Number
1	Handle	
2	Indicator Lamp	
3	Programm Selection Button	
4	Button „HYDR- CYLINDER EXTEND“	
5	Button „HYDR- CYLINDER RETRACT“	
6	Switch- On Button „On/HYDR- PUMP“	
7	Button „OFF/ EMERGENCY OFF“	
8	Cable	

#### Valid for

Remote Control 2- fold Pump	057362
Remote Control 4- fold Pump	057363
Remote Control 6- fold Pump	057364
Remote Control 8- fold Pump	057366
Remote Control 2 Pump	123833
Remote Control 2 Pump CSA	128303

# PERI Rental Criteria

## ACS 100



Remote Control ACS	Description	Instruction	Billing Condition	Type
--------------------	-------------	-------------	-------------------	------



13.10.25 Button „OFF/ EMERGENCY OFF“ missing

■ If possible



■ Or if not possible



13.10.26 Cable | Connections defect

■ If possible











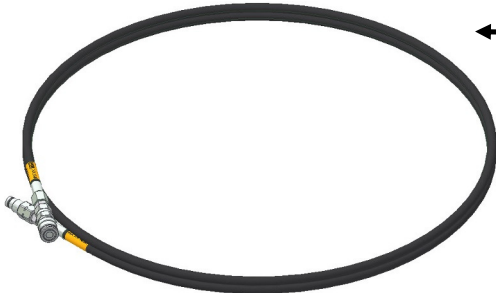

■ Or if not possible

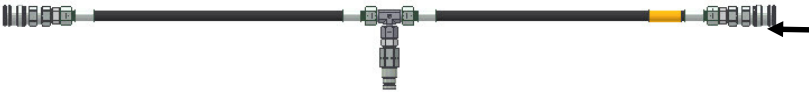

# PERI Rental Criteria

## ACS 100

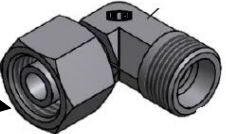

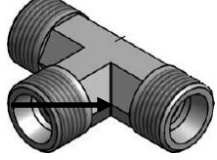
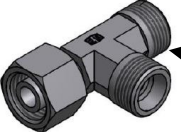
Hoses and Couplers	No.	Name	Article Number
	1	Hydraulic Hose EN853-2SN-DN08	
	2	Hydraulic Hose 2SN-DN08-FF	
	3	Bypass Hose RCS	126646
	4	T-Piece 2SN-DN08-FF	129423
	5	Hydraulic Hose Coupling G12S	129585
	6	FF Coupling Pair	129424
	7	Threaded Plug VSTI R 3/8—ED	057091
	8	Tube Screw Plug ROV 12SX	123881
	9	Threaded Plug VKAM 12S VIT	123880
	10	Elbow Connection X-EVW	051748
	11	Straight Male Stud Coupler	051750
	12	T- Connector X-T	051751
	13	L- Stud X-EVL	051749

# PERI Rental Criteria

## ACS 100



Article	Article number
Hydraulic Hose EN853-2SN-DN08 0,3 m	129587
Hydraulic Hose EN853-2SN-DN08 0,5 m	129592
Hydraulic Hose EN853-2SN-DN08 1,0 m	129593
Hydraulic Hose EN853-2SN-DN08 2,0 m	129594
Hydraulic Hose EN853-2SN-DN08 5,0 m	129595
Hydraulic Hose EN853-2SN-DN08 10,0 m	129596
Hydraulic Hose EN853-2SN-DN08 15,0 m	129597
Hydraulic Hose EN853-2SN-DN08 20,0 m	129598
Hydraulic Hose 2SN-DN12-FF 10,0 m	131019
Hydraulic Hose 2SN-DN12-FF 20,0 m	131021

Article	Article number
Hydraulic Hose 2SN DN08-FF 1,0 m	129035
Hydraulic Hose 2SN DN08-FF 2,0 m	129036
Hydraulic Hose 2SN-DN08-FF 5,0 m	129419
Hydraulic Hose 2SN-DN08-FF 10,0 m	129420
Hydraulic Hose 2SN-DN08-FF 15,0 m	129421
Hydraulic Hose 2SN-DN08-FF 20,0 m	129422

# PERI Rental Criteria

## ACS 100



Hydraulic Hoses	Description	Instruction	Billing Condition	Type
-----------------	-------------	-------------	-------------------	------

### 13.10.27 Hydraulic Hose



- Porous



- Or cut in



### 13.10.28 Age of Hose



- Younger than 6 years











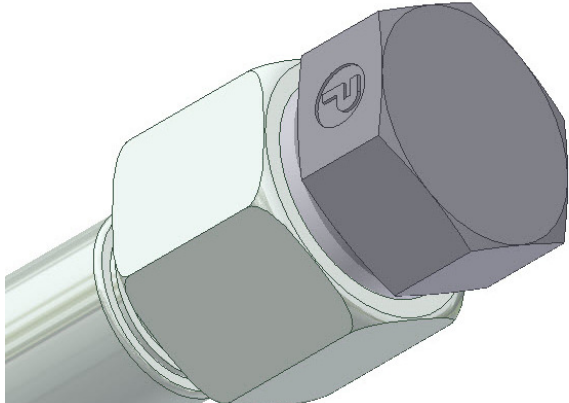

- Older than 6 years

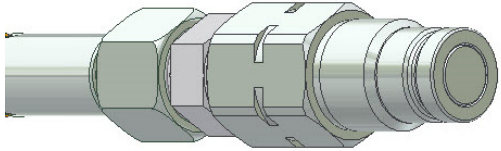

# PERI Rental Criteria

## ACS 100



Hydraulic Hoses	Description	Instruction	Billing Condition	Type
	<b>13.10.29 Tube Screw Plug missing</b>	 123881 (Tube Screw Plug)		
	<b>13.10.30 Sleeve   Pin</b>  <ul style="list-style-type: none"> <li>■ Missing</li>   <li>■ Or damaged due to force</li> </ul>	<ul style="list-style-type: none"> <li>  128993 (Sleeve) 128992 (Pin)           </li>   <li>  128993 (Sleeve) 128992 (Pin)           </li> </ul>	<ul style="list-style-type: none"> <li>  </li>   <li>  </li> </ul>	<ul style="list-style-type: none"> <li>  </li>   <li>  </li> </ul>

# PERI Rental Criteria

## ACS 100



Climbing Rail ACS	No.	Name	Article Number
-------------------	-----	------	----------------

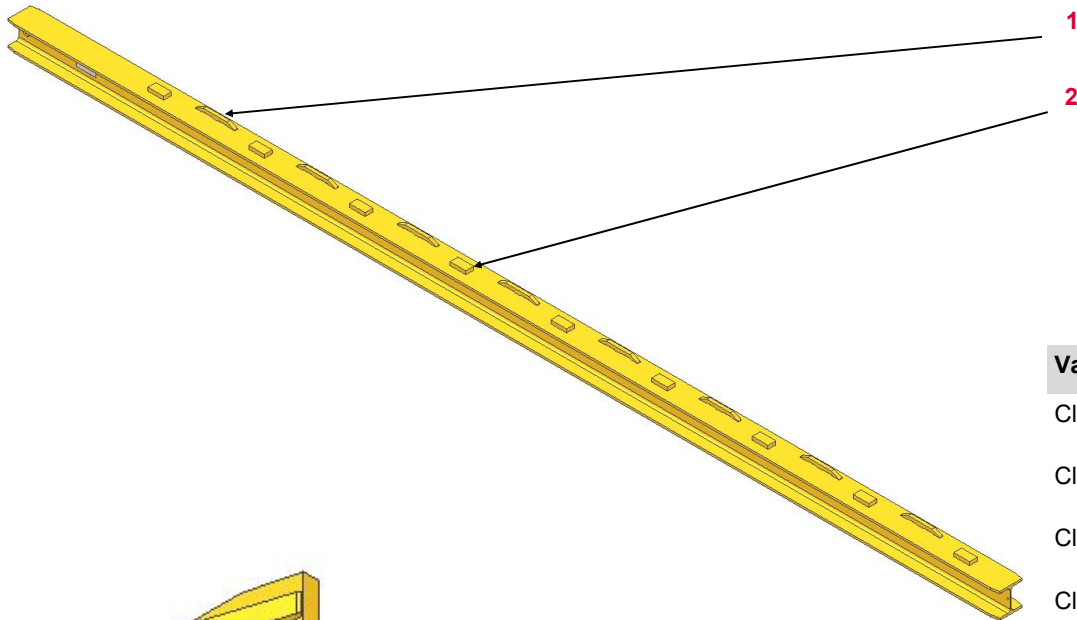

1	Switch Guide
2	Support Block
3	Hook

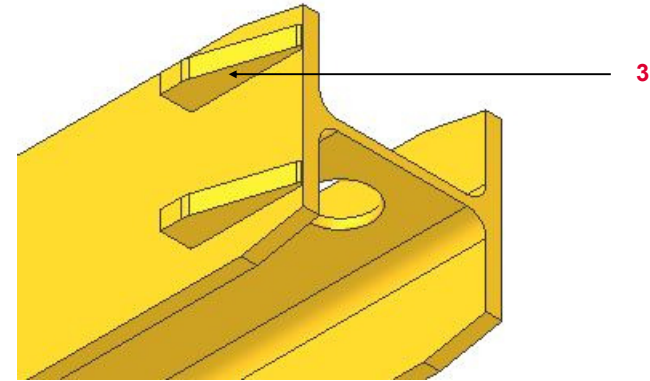



















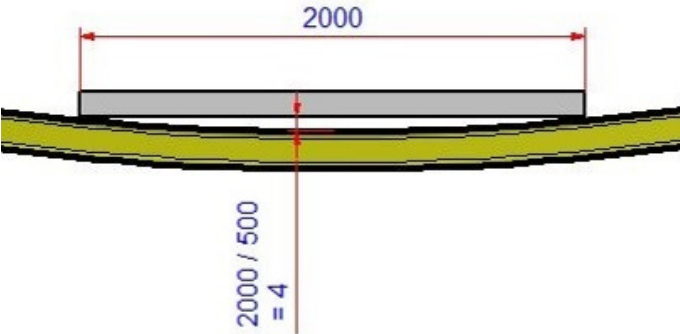

### Valid for

Climbing Rail ACS 630	051731
Climbing Rail ACS 694	057213
Climbing Rail ACS 758	051732
Climbing Rail ACS 822	057215

# PERI Rental Criteria

## ACS 100



Climbing Rail ACS	Description	Instruction	Billing Condition	Type
	<b>13.10.31 Support Block</b>			
	<ul style="list-style-type: none"> <li>■ Worn &gt; 1 mm</li> </ul>	 		
	<ul style="list-style-type: none"> <li>■ Or deformed</li> </ul>	 		
	<ul style="list-style-type: none"> <li>■ Or crack in welding</li> </ul>	 		
	<b>13.10.32 Bent</b>			
	<ul style="list-style-type: none"> <li>■ ≤ permitted bent (L/500)</li> </ul>			
	<ul style="list-style-type: none"> <li>■ Or &gt; permitted bent (L/500)</li> </ul>	 		
	<b>Valid for</b>	<b>Perm. bent</b>		
	Climbing Rail ACS 630	13 mm		
	Climbing Rail ACS 694	14 mm		
	Climbing Rail ACS 758	15 mm		
	Climbing Rail ACS 822	16 mm		



# PERI Rental Criteria

## ACS 100



Climbing Rail ACS	Description	Instruction	Billing Condition	Type
-------------------	-------------	-------------	-------------------	------



13.10.33 Non Standard Support Blocks





















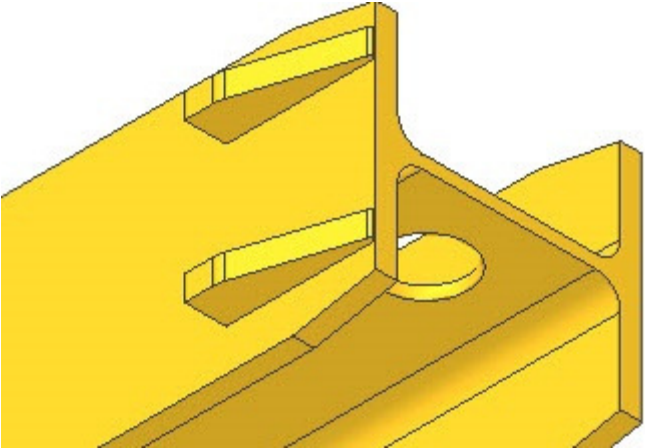

13.10.34 Different Support Block sizes



# PERI Rental Criteria

## ACS 100



Climbing Rail ACS	Description	Instruction	Billing Condition	Type
	<b>13.10.35 Switch Guide</b>			
	<ul style="list-style-type: none"> <li>■ Missing</li> </ul>	 		
	<ul style="list-style-type: none"> <li>■ Or worn at the thrust surface (pressure marks)</li> </ul>	 		
	<b>13.10.36 Hook</b>			
	<ul style="list-style-type: none"> <li>■ Missing</li> </ul>	 		
	<ul style="list-style-type: none"> <li>■ Or damaged due to force (deformed, crack in welding )</li> </ul>	 		
	<ul style="list-style-type: none"> <li>■ Or worn</li> </ul>	 		

# PERI Rental Criteria

## ACS 100



### Main Platform Beam ACS

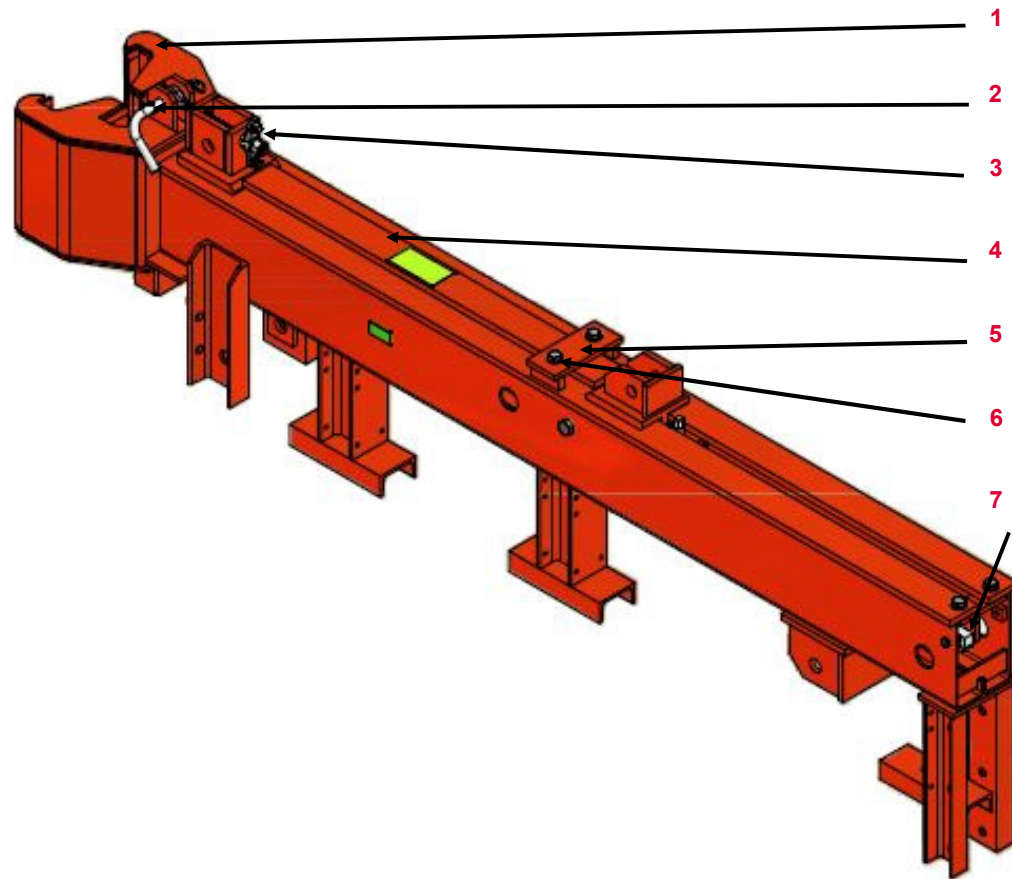

No.	Name	Article Number
1	Head Adapter	706386
2	Pin	706636
3	Wing Nut	030100
4	Carriage	051704
5	Connection Splice	706660
6	Bolt M 16 x 65	710313
7	Mechanical Drive	051705

Valid for	
Main Plattform Beam ACS w. Car/A-M	051701
Main Plattform Beam ACS w. Car/H-DR	051702
Main Plattform Beam ACS w. Car	051700
Main Plattform Beam ACS	051703

# PERI Rental Criteria

## ACS 100



Main Plattform Beam	Description	Instruction	Billing Condition	Type
	<b>13.10.37 Worn</b>			
	<ul style="list-style-type: none"> <li>■ <math>\leq 4</math> mm And welding not damaged</li> </ul>			
	<ul style="list-style-type: none"> <li>■ <math>&gt; 4</math> mm</li> </ul>	706386 (Head Adapter )		
	<ul style="list-style-type: none"> <li>■ Or welding damaged</li> </ul>	706386 (Head Adapter )		
	<b>13.10.38 Plaids bent</b>			
	<ul style="list-style-type: none"> <li>■ If possible</li> </ul>			
	<ul style="list-style-type: none"> <li>■ Or if not possible</li> </ul>	706386 (Head Adapter )		
	<ul style="list-style-type: none"> <li>■ Or welding damaged</li> </ul>	706386 (Head Adapter )		

# PERI Rental Criteria

## ACS 100



Main Plattform Beam	Description	Instruction	Billing Condition	Type
---------------------	-------------	-------------	-------------------	------

### 13.10.39 Connection holes worn



- > Ø 32 mm

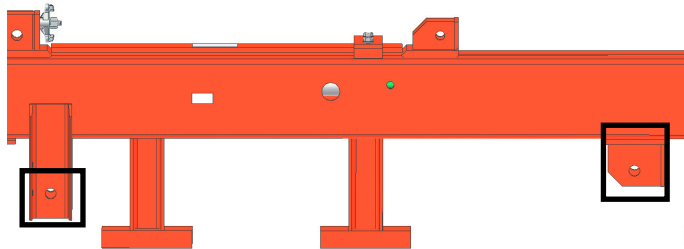

Nominal Dimension  
Ø 31 mm



### 13.10.40 Support Bent

- If possible



- Or if not possible



# PERI Rental Criteria

## ACS 100



### Carriage ACS (051704)

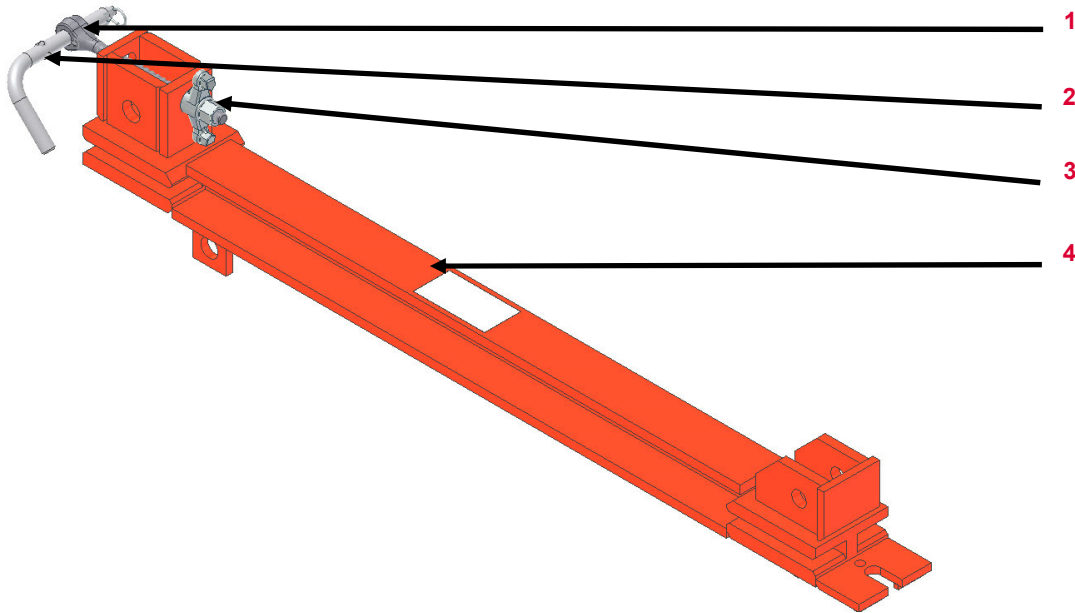

No.	Name	Article Number
1	Tie Yoke	037150
2	Pin	037160
3	Wing Nut	030100
4	Carriage	

# PERI Rental Criteria

## ACS 100

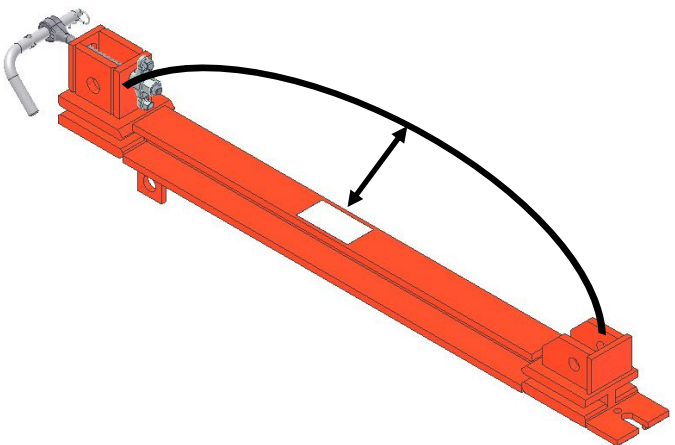
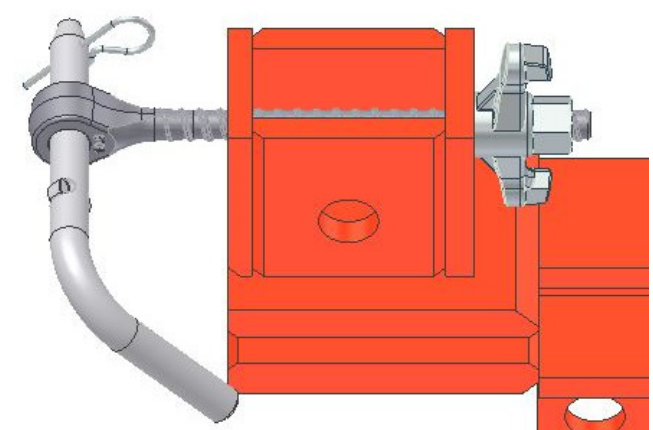

Carriage	Description	Instruction	Billing Condition	Type
	<b>13.10.41 Carriage deformed</b>			
	<ul style="list-style-type: none"> <li>■ <math>\leq 5\text{mm}</math> (L/300) and moveable in beam</li> <li>■ Or <math>&gt; 5\text{mm}</math></li> </ul>	<ul style="list-style-type: none"> <li>✓</li> <li>✗</li> </ul>	<ul style="list-style-type: none"> <li>🚫</li> <li>📦</li> </ul>	<ul style="list-style-type: none"> <li>👁️</li> <li>⚠️</li> </ul>
	<b>13.10.42 Pin   Cotter Pin   Tie Yoke Wing Nut</b>			
	<ul style="list-style-type: none"> <li>■ Missing</li> <li>■ Or damaged due to force</li> </ul>	<ul style="list-style-type: none"> <li>🔧</li> <li>⚙️</li> </ul>	<ul style="list-style-type: none"> <li>📦</li> <li>📦</li> </ul>	<ul style="list-style-type: none"> <li>⚙️</li> <li>⚙️</li> </ul>

# PERI Rental Criteria

## ACS 100



### Mechanical Drive ACS (051705)

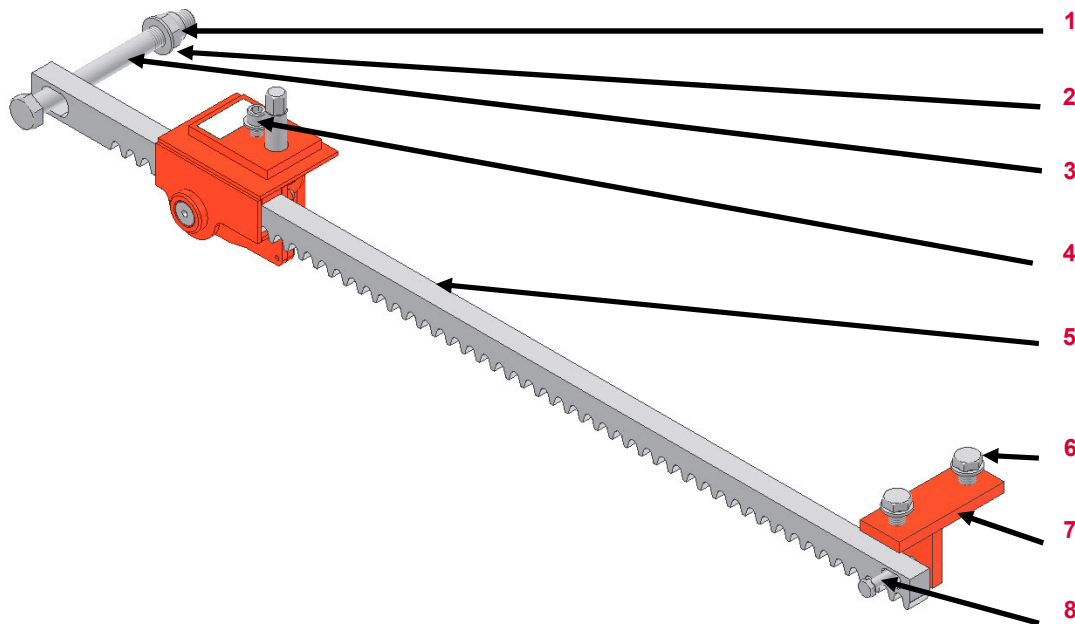











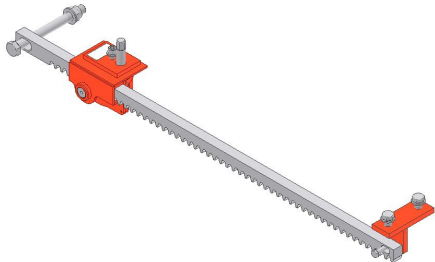





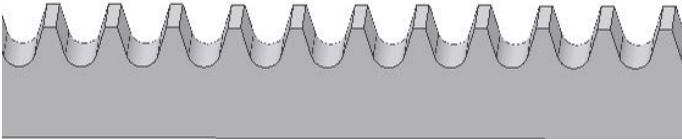

No.	Name	Article Number
1	Nut M20	781053
2	Washer 20—200 HV	706454
3	Bolt M20 x 200	706462
4	Bolt M12 x 35	706461
5	Rack	706463
6	Bolt M16 x 45	710225
7	Plate	706658
8	Bolt M10 x 80	710593

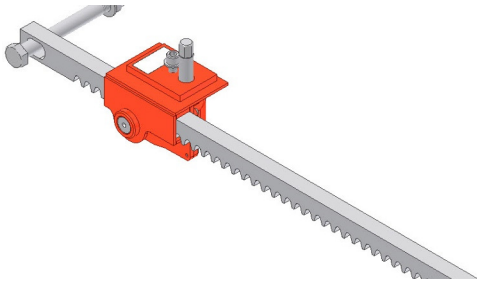

# PERI Rental Criteria

## ACS 100



Mechanical Drive	Description	Instruction	Billing Condition	Type
	<b>13.10.43 Mechanical Drive</b>			
	<ul style="list-style-type: none"> <li>■ Worn</li> <li>■ Or damaged due to force</li> <li>■ Or cracks in housing</li> </ul>	 	 	 
	<b>13.10.44 Rag</b>			
	<ul style="list-style-type: none"> <li>■ Worn</li> <li>■ Or damaged due to force</li> </ul>	 	 	 
	<b>13.10.45 Function of Drive not given</b>			
	<ul style="list-style-type: none"> <li>■ Worn</li> <li>■ Or damaged due to force</li> </ul>	 051706 (Drive)  051706 (Drive)	 	 

# PERI Rental Criteria

## ACS 100



Main Platform Beam ACS-P	No.	Name	Article Number
--------------------------	-----	------	----------------

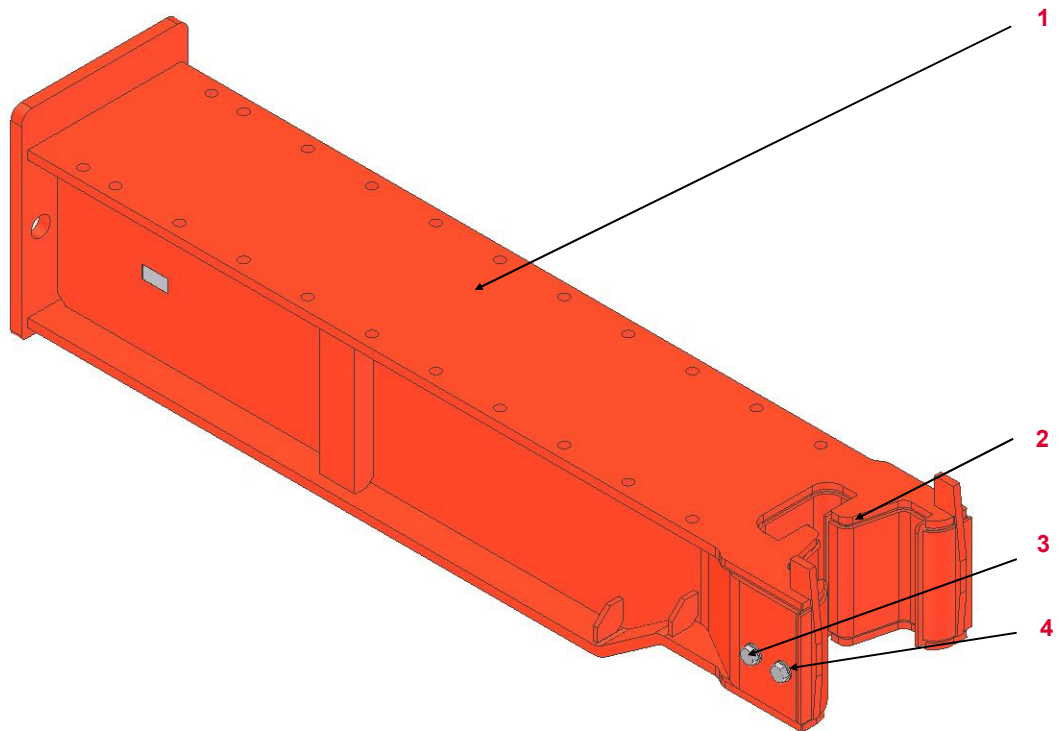

1	Main Platform Beam	
2	Head	
3	Bolt M 20 x 40	706458
4	Washer	706454

### Valid for

Main Platform Beam ACS 1400 single	057000
Main Platform Beam ACS 1550 single	057001
Main Platform Beam ACS 1700 single	057002
Main Platform Beam ACS 1850 single	057003
Main Platform Beam ACS 2000 single	057004
Main Platform Beam ACS 2150 single	057005
Main Platform Beam ACS 2300 single	057006
Main Platform Beam ACS- P	057013

# PERI Rental Criteria

## ACS 100



Main Platform Beam ACS-P	Description	Instruction	Billing Condition	Type
	<b>13.10.46 Worn</b>			
	<ul style="list-style-type: none"> <li>■ <math>\leq 4</math> mm And welding not damaged</li> </ul>			
	<ul style="list-style-type: none"> <li>■ <math>&gt; 4</math> mm</li> </ul>			
	<ul style="list-style-type: none"> <li>■ Or welding damaged</li> </ul>			
	<b>13.10.47 Plaids bent</b>			
	<ul style="list-style-type: none"> <li>■ If possible</li> </ul>			
	<ul style="list-style-type: none"> <li>■ Or if not possible</li> </ul>			
	<ul style="list-style-type: none"> <li>■ Or welding damaged</li> </ul>			

# PERI Rental Criteria

## ACS 100



Main Platform End Piece– P (057060)	Description	Instruction	Billing Condition	Type
-------------------------------------	-------------	-------------	-------------------	------



13.10.48 U– Profile bent

- If possible



- Or if not possible



# PERI Rental Criteria

## ACS 100



Vertical Post	No.	Name	Article Number
---------------	-----	------	----------------

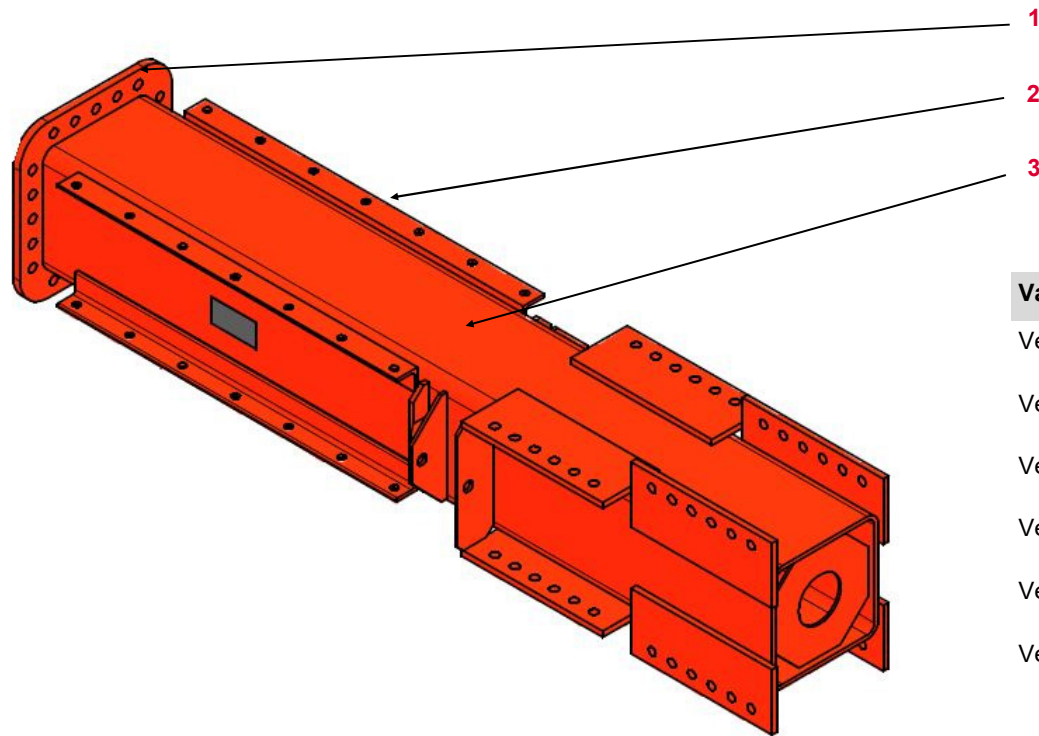

1	1	Head Plate
2	2	Plate
3	3	Tube













### Valid for

Vertical Post Top 2100 ACS	057016
Vertical Post Intermediate 1200 ACS	057067
Vertical Post Intermediate 900 ACS	057017
Vertical Post Intermediate 600 ACS	057018
Vertical Post Intermediate 300 ACS	057019
Vertical Post Base 2075 ACS	057020

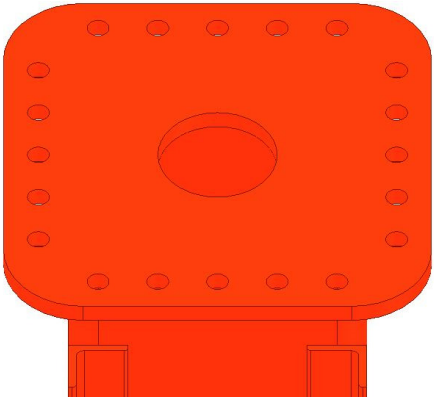
# PERI Rental Criteria

## ACS 100



Vertical Post	Description	Instruction	Billing Condition	Type
	<b>13.10.49 Plate bent</b>	<ul style="list-style-type: none"> <li>■ If possible</li> </ul>		
	<ul style="list-style-type: none"> <li>■ Or if not possible</li> </ul>			
	<b>13.10.50 Head plate bent</b>	<ul style="list-style-type: none"> <li>■ If possible</li> </ul>		
	<ul style="list-style-type: none"> <li>■ Or if not possible</li> </ul>			

# PERI Rental Criteria

## ACS 100



Climbing Shoe I (051725)	Climbing Shoe II (051726   057875)	No.	Name	Article Number
--------------------------	------------------------------------	-----	------	----------------

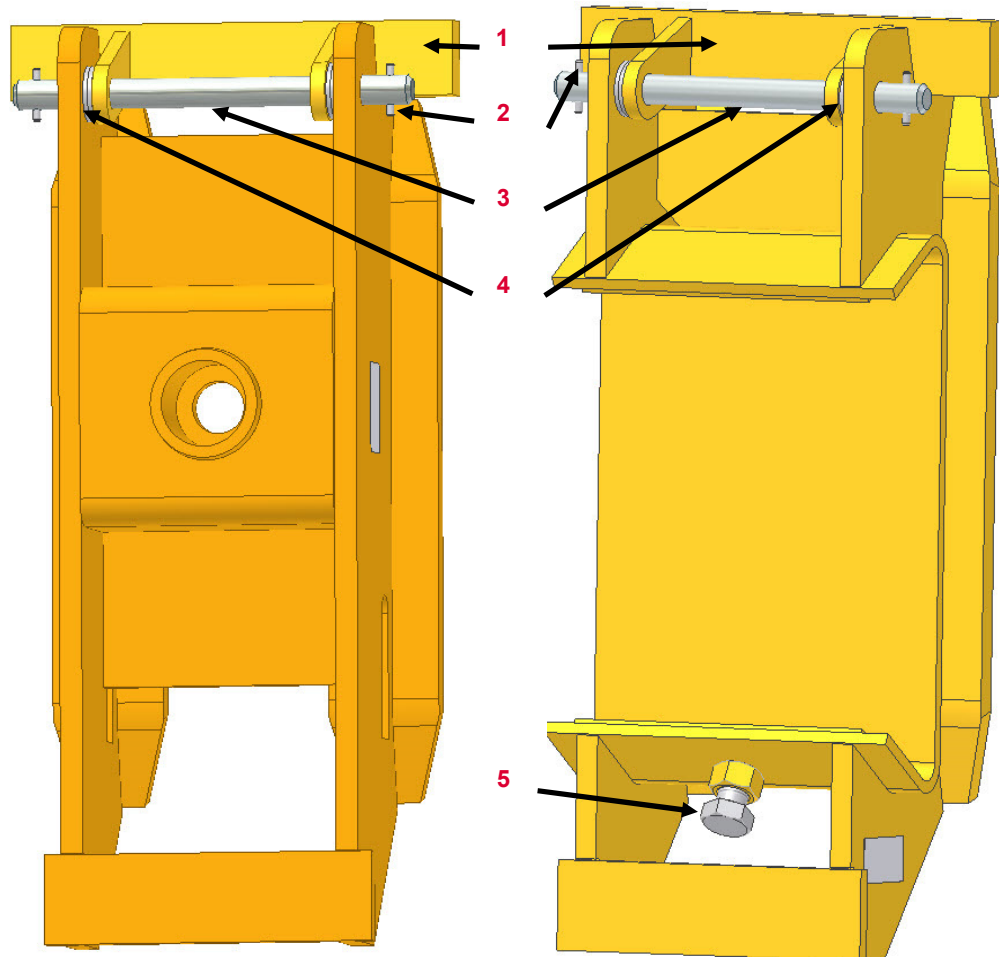

1	Flap	057549
2	Dowel Pin 5,0 x 35	711063
3	Pin 20 x 270 ACS	706455
4	Washer	706455
5	Bolt M 20 x 40	706458

# PERI Rental Criteria

## ACS 100



### Climbing Shoe IV (057568)

No. Name Article Number

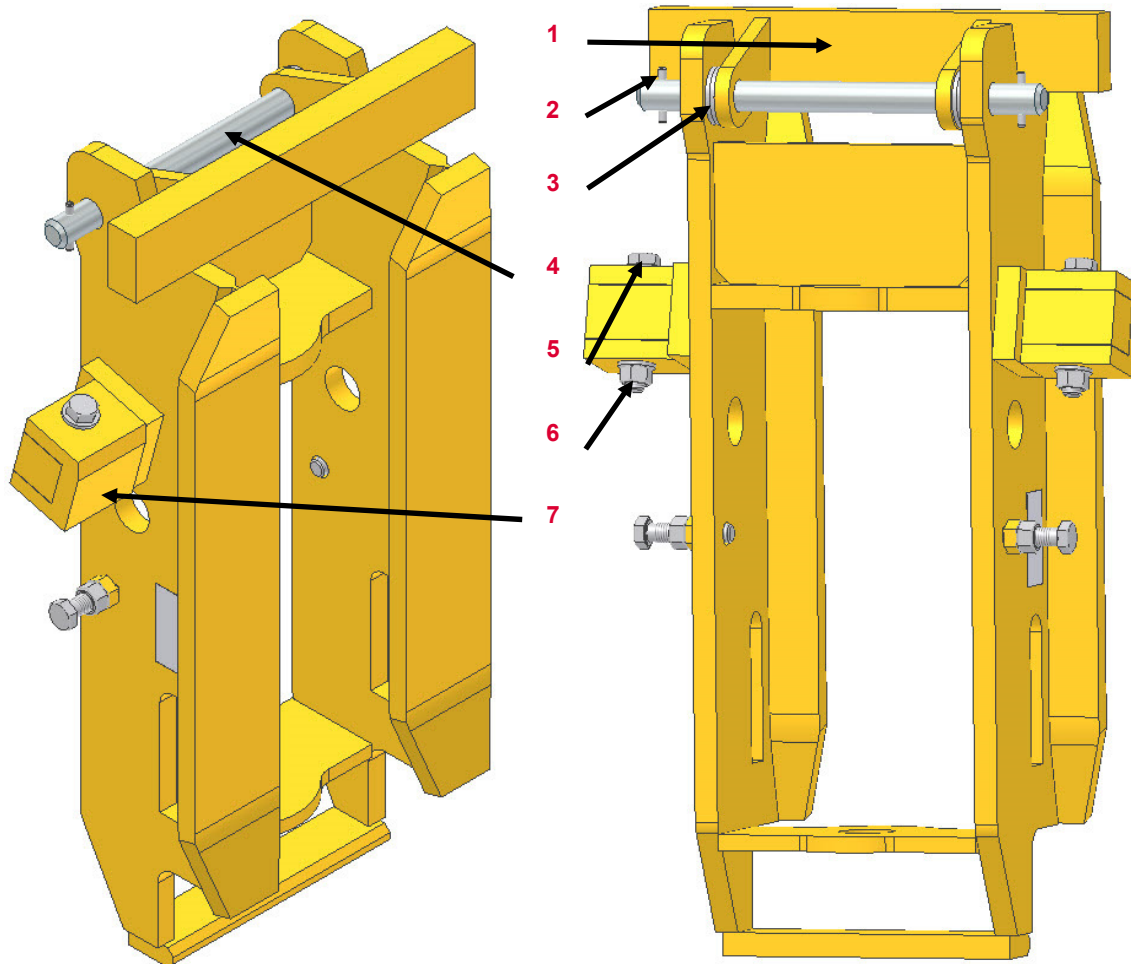











1	Flap	057549
2	Dowel Pin 5 x 35	711063
3	Washer	706454
4	Pin 20 x 270	706455
5	Bolt M 12 x 80	710220
6	Nut M 12	710330
7	Spacer Piece	057594



# PERI Rental Criteria

## ACS 100



Climbing Shoe (051725)	Description	Instruction	Billing Condition	Type
	<b>13.10.51 Sleeve bent</b>	 		
	<ul style="list-style-type: none"> <li>■ <math>\varnothing &lt; 72.5</math></li> </ul>			
	<b>13.10.52 Rails</b>	 		
	<ul style="list-style-type: none"> <li>■ Worn <math>d &lt; 258</math> mm</li> </ul>			

# PERI Rental Criteria

## ACS 100



Climbing Shoe	Description	Instruction	Billing Condition	Type	
	<b>13.10.53 Flap</b>				
	<ul style="list-style-type: none"> <li>■ Missing</li> </ul>				
	<ul style="list-style-type: none"> <li>■ Or damaged due to force</li> </ul>		057549 (Flap) 706455 (Pin) 711063 (Cotter Pin)		
	<ul style="list-style-type: none"> <li>■ Or not moveable</li> <li>■ Or incorrect assembled washers</li> </ul>	 	Correct assembly of washers	 	 
	<b>13.10.54 Hole at Flap</b>				
	<ul style="list-style-type: none"> <li>■ Original geometry given</li> <li>■ Or not given anymore</li> </ul>	 	 	 	

# PERI Rental Criteria

## ACS 100



Double Anchor Support (051727; 051774)	Description	Instruction	Billing Condition	Type
--	-------------	-------------	-------------------	------



### 13.10.55 Handle

- Bent
- Or broken

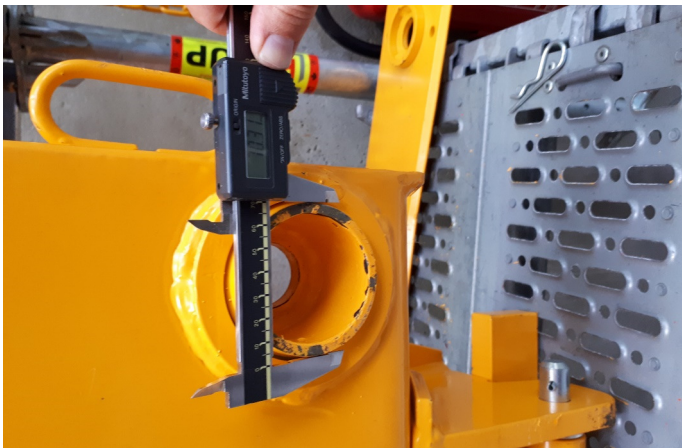

### 13.10.56 Sleeve bent

- $\varnothing < 69,0$  mm
- Or  $\varnothing > 71,5$  mm



# PERI Rental Criteria

## ACS 100



Vertical Strut ACS (051710)	Description	Instruction	Billing Condition	Type
-----------------------------	-------------	-------------	-------------------	------



### 13.10.57 Strut bent | Buckled

- > 5 mm



- Or edges affected

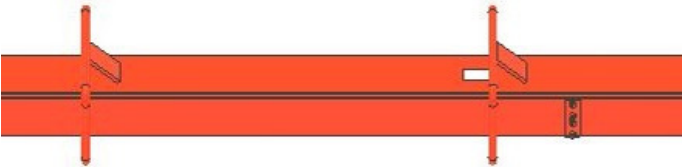

### 13.10.58 Brackets | Hatchets

- Bent



- Or missing



# PERI Rental Criteria

## ACS 100



Vertical Strut ACS (051710)	Description	Instruction	Billing Condition	Type
-----------------------------	-------------	-------------	-------------------	------

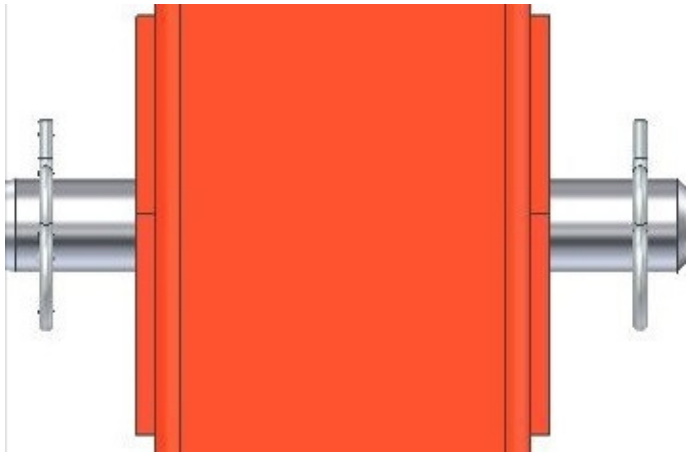

**13.10.59 Pin | Cotter Pin | Bolt missing**

 706372 (Pin)  
 022230 (Cotter Pin)  
 710295 (Bolt)

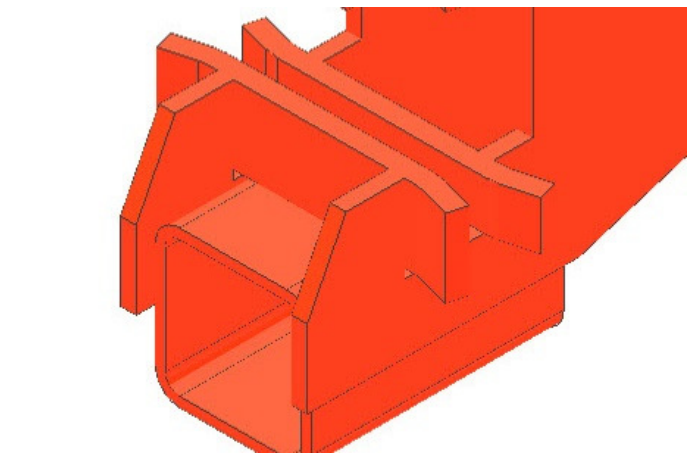

**13.10.60 Guide plates bent**

■ If possible















■ Or if not possible

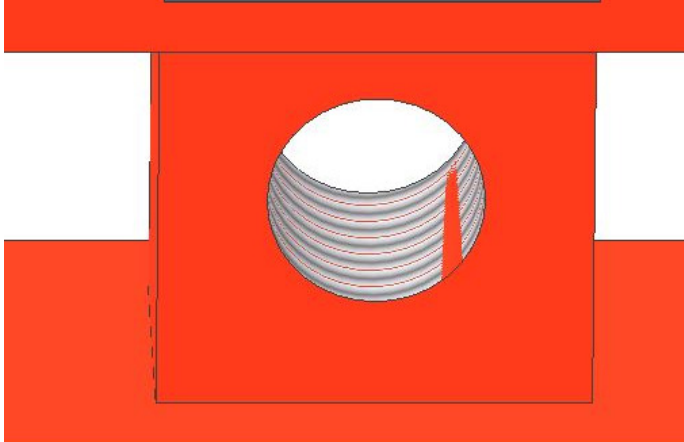

# PERI Rental Criteria

## ACS 100



Sliding Unit (051711)	Description	Instruction	Billing Condition	Type
	<b>13.10.61 Bent</b>	<ul style="list-style-type: none"> <li>■ If possible</li> </ul>		
	<ul style="list-style-type: none"> <li>■ Or if not possible</li> </ul>			
	<b>13.10.62 Thread</b>	<ul style="list-style-type: none"> <li>■ Soiled</li> </ul>		
	<ul style="list-style-type: none"> <li>■ Or thread damaged</li> </ul>	 Recut the thread		

# PERI Rental Criteria

## ACS 100



Compression Spindle ACS (051712)	Description	Instruction	Billing Condition	Type
----------------------------------	-------------	-------------	-------------------	------

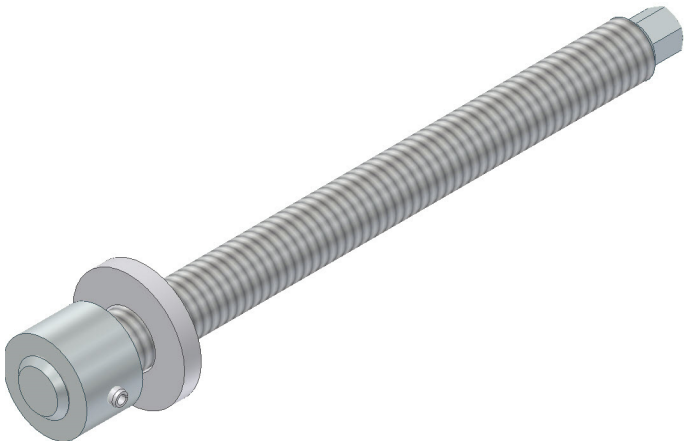

13.10.63 Thread Damaged

- Function not given

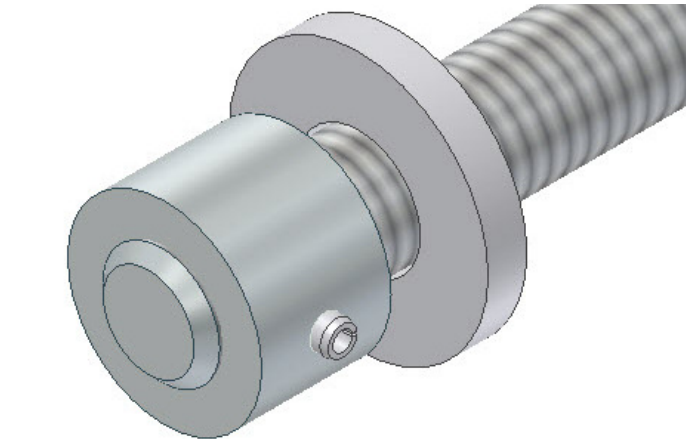

13.10.64 Dowel Pin | Washer missing

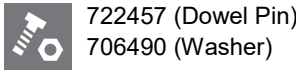

# PERI Rental Criteria

## ACS 100



Compression Strut ACS (051714)	Description	Instruction	Billing Condition	Type
--------------------------------	-------------	-------------	-------------------	------

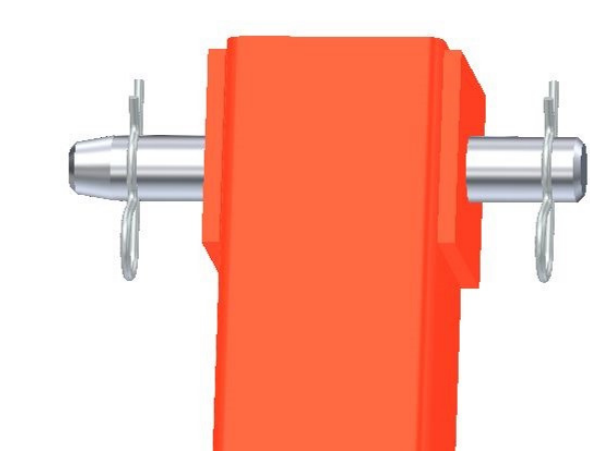

**13.10.65 Pin | Cotter Pin**

- Missing
- Or damaged due to force

 706372 (Pin)  
022230 (Cotter Pin)



 706372 (Pin)  
022230 (Cotter Pin)

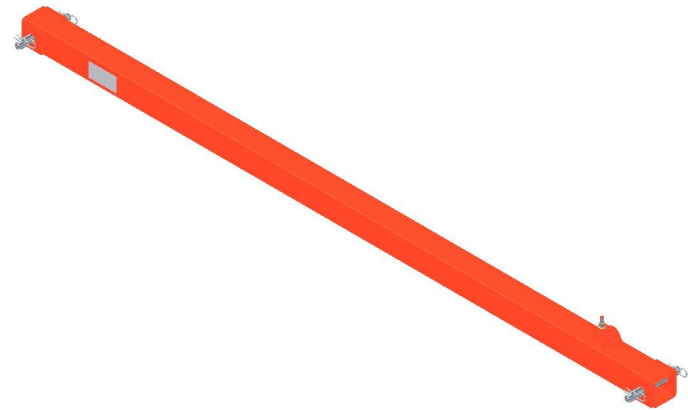

**13.10.66 Bent**

- > 6 mm (l/500)





# PERI Rental Criteria

## ACS 100



Handrail Post (051707; 051718; 051719)	Description	Instruction	Billing Condition	Type
--	-------------	-------------	-------------------	------

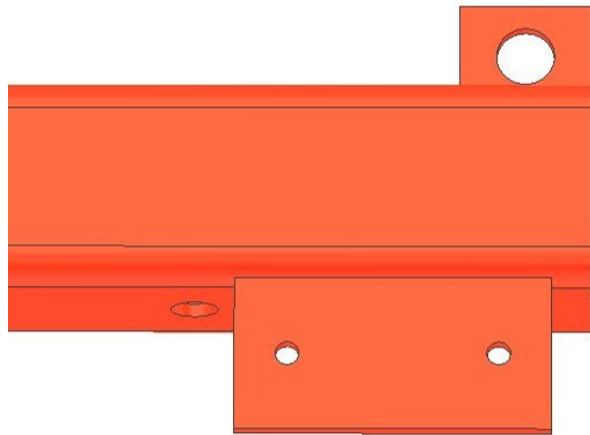

### 13.10.67 Plaids

- Missing
- Or bent

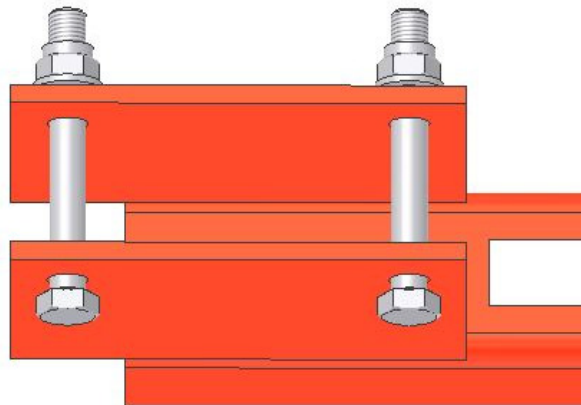

### 13.10.68 Bolts | Nuts

- Missing
- Or damaged due to force



710232 (Bolt)  
070890 (Nut)  
711074 (Washer)











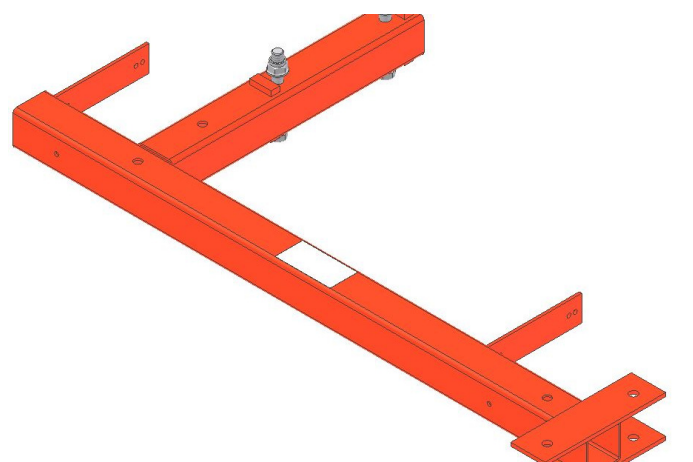

710232 (Bolt)  
070890 (Nut)  
711074 (Washer)

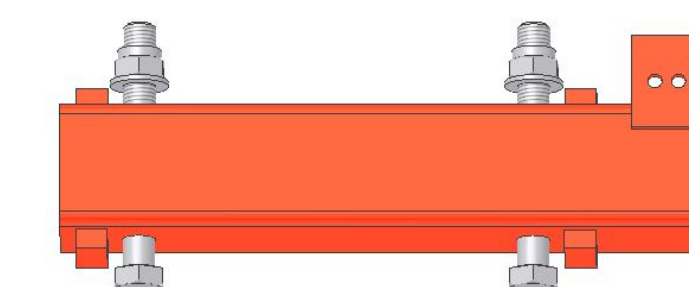

# PERI Rental Criteria

## ACS 100



Main cantilever Beam ACS (051716)	Description	Instruction	Billing Condition	Type
	<p><b>13.10.69 Plaids</b></p> <ul style="list-style-type: none"> <li>■ Missing</li> <li>■ Or bent</li> </ul>	<ul style="list-style-type: none"> <li></li> <li></li> </ul>	<ul style="list-style-type: none"> <li></li> <li></li> </ul>	<ul style="list-style-type: none"> <li></li> <li></li> </ul>
	<p><b>13.10.70 Bolts   Nuts</b></p> <ul style="list-style-type: none"> <li>■ Missing</li> <li>■ Or damaged due to force</li> </ul>	<ul style="list-style-type: none"> <li> 781054 (Bolt) 781053 (Nut) 706545 (Washer)</li> <li> 781054 (Bolt) 781053 (Nut) 706545 (Washer)</li> </ul>	<ul style="list-style-type: none"> <li></li> <li></li> </ul>	<ul style="list-style-type: none"> <li></li> <li></li> </ul>

# PERI Rental Criteria

## ACS 100



Lower Cantilever Beam ACS (051720)	Description	Instruction	Billing Condition	Type
------------------------------------	-------------	-------------	-------------------	------

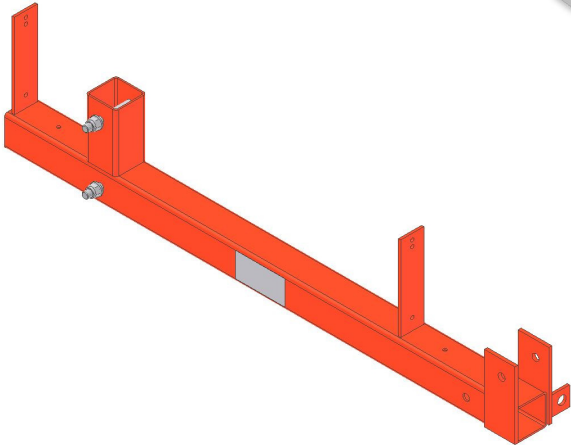

**13.10.71 Plaids**

- Missing
- Or bent

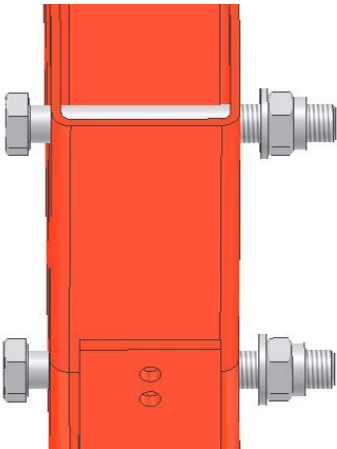

**13.10.72 Bolts | Nuts**

- Missing
- Or damaged due to force



710232 (Bolt)  
070890 (Nut)  
711074 (Washer)



710232 (Bolt)  
070890 (Nut)  
711074 (Washer)



# PERI Rental Criteria

## ACS 100



Lower Cantilever Beam 360 ACS (051721)	Description	Instruction	Billing Condition	Type
--	-------------	-------------	-------------------	------

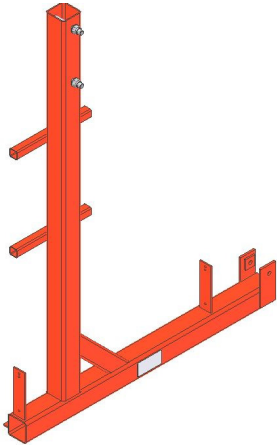

### 13.10.73 Plaids

- Missing



- Or bent

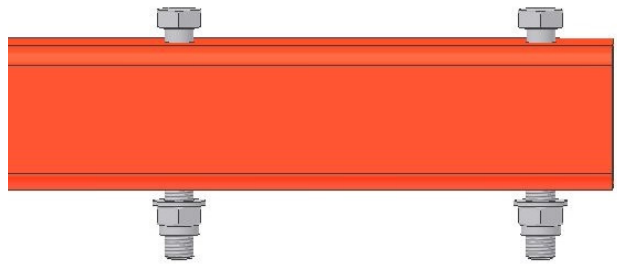

### 13.10.74 Bolts | Nuts

- Missing



781054 (Bolt)  
781053 (Nut)  
706454 (Washer)



- Or damaged due to force



781054 (Bolt)  
781053 (Nut)  
706454 (Washer)



# PERI Rental Criteria

## ACS 100



Cantilever Post (051722; 051723; 051724)	Description	Instruction	Billing Condition	Type
--	-------------	-------------	-------------------	------

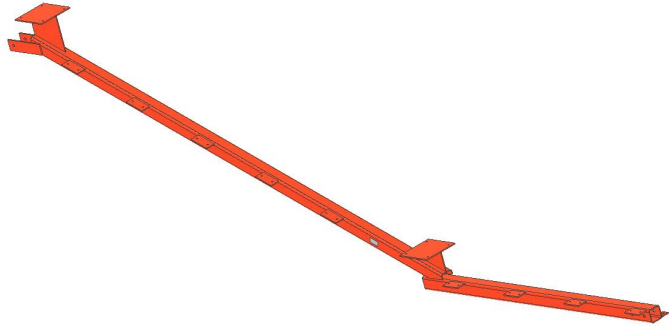

13.10.75 Bend | Buckled

- > l/350

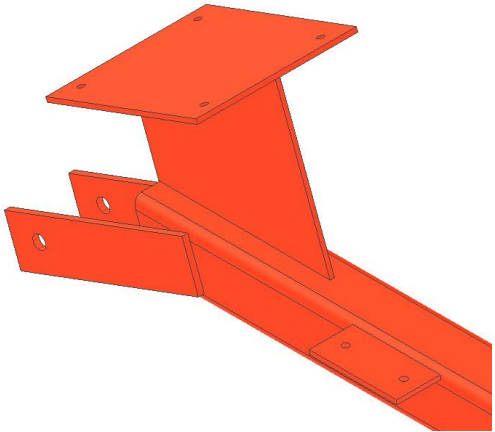

13.10.76 Plaids bent

- If possible



- Or if not possible



# PERI Rental Criteria

## ACS 100



Strongback ACS (057097; 057098)	No.	Name	Article Number
---------------------------------	-----	------	----------------

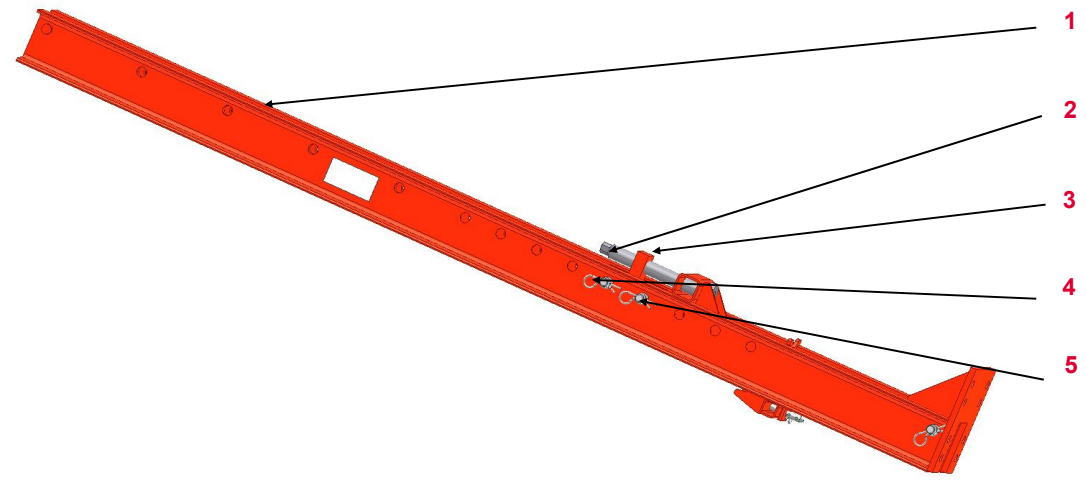



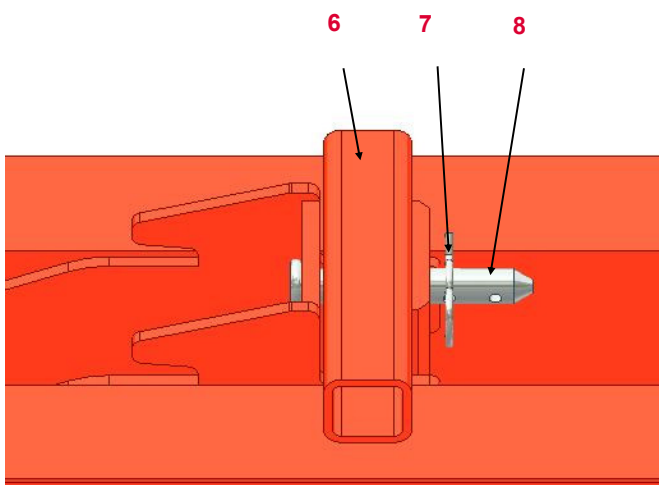







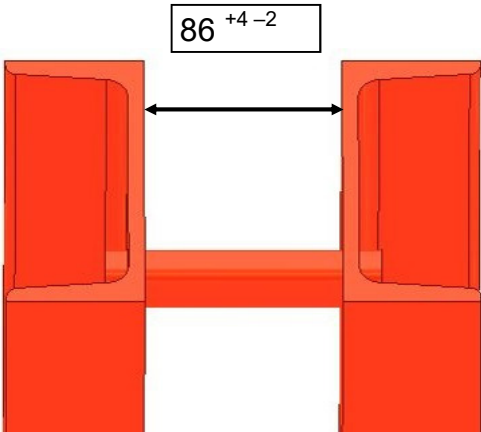

1	Strongback	
2	Adjusting Spindle	057081
3	Adjusting Nut	057307
4	Cotter Pin 5/1	022230
5	Pin 25x180	715936
6	Counter Plate	057315
7	Cotter Pin 4/1	018060
8	Pin	018050

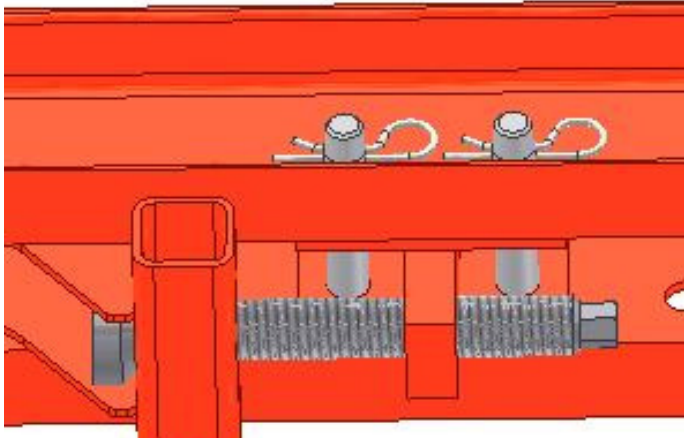

# PERI Rental Criteria

## ACS 100



Strongback	Description	Instruction	Billing Condition	Type
	<p><b>13.10.77 Distance between U- Pieces not in tolerance</b></p> <ul style="list-style-type: none"> <li>■ If possible</li> <li>■ Or if not possible</li> </ul>	<ul style="list-style-type: none"> <li>■ </li> <li>■ </li> </ul>	<ul style="list-style-type: none"> <li>■ </li> <li>■ </li> </ul>	<ul style="list-style-type: none"> <li>■ </li> <li>■ </li> </ul>
	<p><b>13.10.78 Pin   Cotter Pin   Spindle</b></p> <ul style="list-style-type: none"> <li>■ Missing</li> <li>■ Or damaged due to force</li> </ul>	<ul style="list-style-type: none"> <li>■ </li> <li>■ </li> </ul>	<ul style="list-style-type: none"> <li>■ </li> <li>■ </li> </ul>	<ul style="list-style-type: none"> <li>■ </li> <li>■ </li> </ul>

# PERI Rental Criteria

## ACS 100



Strongback Adaptor (057327; 057332)	No.	Name	Article Number
	1	Hex. Bolt	057139
	2	Washer	706454
	3	Hex. Bolt	710334
	4	Pin	706372
	5	Cotter Pin 5/1	022230



Damage	Description	Instruction	Billing Condition	Type
	<b>13.10.79 Bolt   Cotter Pin   Nut   Pin</b>			
	<ul style="list-style-type: none"> <li>Missing</li> <li>Or damaged due to force</li> </ul>	 	 	 
	<b>13.10.80 Plaids bent</b>			
	<ul style="list-style-type: none"> <li>If possible</li> <li>Or if not possible</li> </ul>	 	 	 



# PERI Rental Criteria

## ACS 100











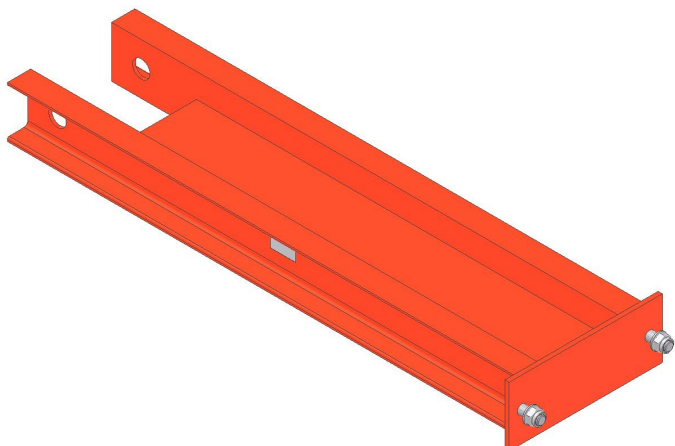

Diagonal Strut (057061)	Description	Instruction	Billing Condition	Type
	<b>13.10.81 Pin   Spring Pin   Cotter Pin</b>	<ul style="list-style-type: none"> <li>            057135 (Pin)            022230 (Spring Pin)            770012 (Cotter Pin)         </li> </ul>		
	<ul style="list-style-type: none"> <li>           ■ Missing         </li> </ul>	<ul style="list-style-type: none"> <li>            057135 (Pin)            022230 (Spring Pin)            770012 (Cotter Pin)         </li> </ul>		
	<b>13.10.82 Plaids Bent</b>			
	<ul style="list-style-type: none"> <li>           ■ Or damaged due to force         </li> </ul>			

# PERI Rental Criteria

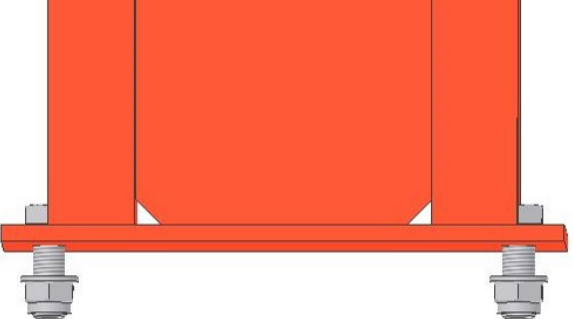
## ACS 100



Vertical Strut (057062)	Description	Instruction	Billing Condition	Type
	<p><b>13.10.83 Bent</b></p> <ul style="list-style-type: none"> <li>■ If possible</li> <li>■ Or if not possible</li> </ul>	<ul style="list-style-type: none"> <li>  </li> <li>  </li> </ul>	<ul style="list-style-type: none"> <li>  </li> <li>  </li> </ul>	<ul style="list-style-type: none"> <li>  </li> <li>  </li> </ul>
		<p><b>13.10.84 Bolt   Nut   Washer</b></p> <ul style="list-style-type: none"> <li>■ Missing</li> <li>■ Or damaged due to force</li> </ul>	<ul style="list-style-type: none"> <li>  <p>057139 (Bolt) 781053 (Nut) 706454 (Washer)</p> </li> <li>  <p>057139 (Bolt) 781053 (Nut) 706454 (Washer)</p> </li> </ul>	<ul style="list-style-type: none"> <li>  </li> <li>  </li> </ul>

# PERI Rental Criteria

## ACS 100



Beam Head Fixing ACS- P (057014)	Description	Instruction	Billing Condition	Type
----------------------------------	-------------	-------------	-------------------	------

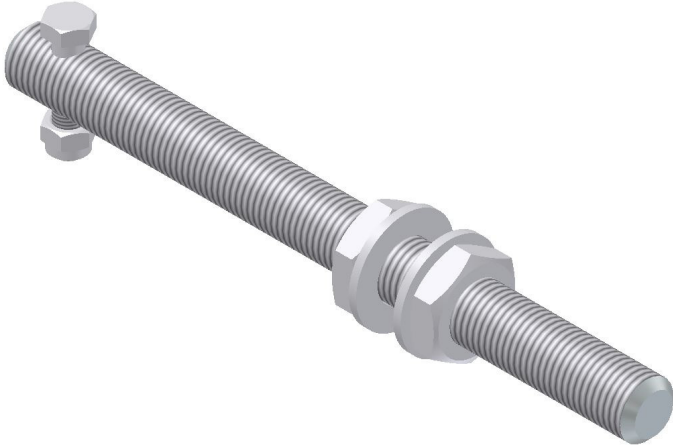

**13.10.85 Bolt | Nut | Washer**

- Missing
  
- Or damaged due to force

	114792 (Nut M 36) 114784 (Washer) 714093 (Bolt M 16) 070890 (Nut M 16)					
				114792 (Nut M 36) 114784 (Washer) 714093 (Bolt M 16) 070890 (Nut M 16)		

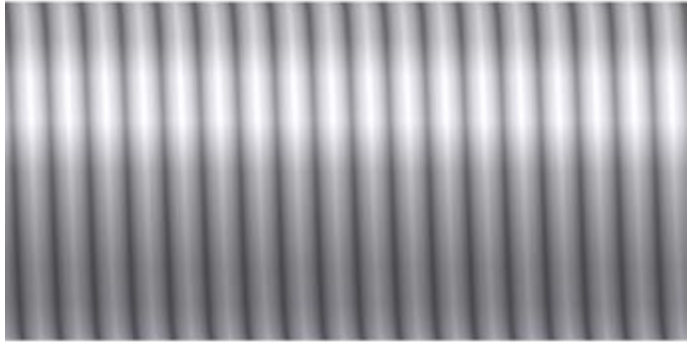

**13.10.86 Thread**

- Soiled
  
- Or bent
  
- Or worn

# PERI Rental Criteria

## ACS 100



Carriage ACS- P (057015)	Description	Instruction	Billing Condition	Type
--------------------------	-------------	-------------	-------------------	------



13.10.87 Plaids bent

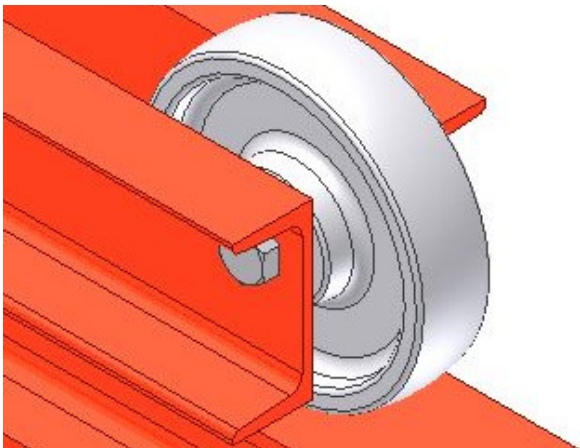

13.10.88 Heavy Duty Roller

■ Worn



057164 (Heavy Duty Roller)  
070890 (Nut M 16)  
710225 (Bolt M 16 x 45)



■ Or damaged due to force



057164 (Heavy Duty Roller)  
070890 (Nut M 16)  
710225 (Bolt M 16 x 45)



# PERI Rental Criteria



## ACS 100

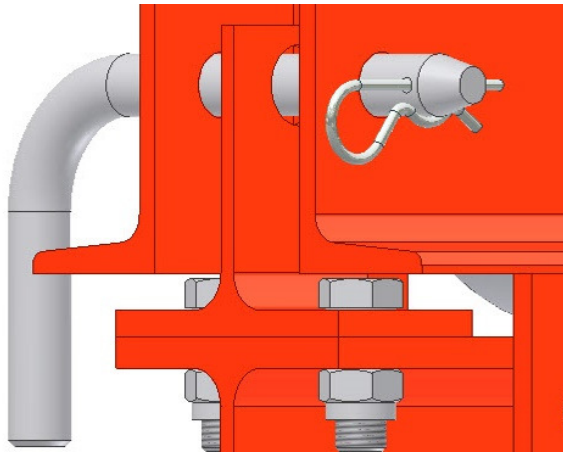

Carriage ACS– P (057015)	Description	Instruction	Billing Condition	Type
--------------------------	-------------	-------------	-------------------	------





13.10.89 Pin | Cotter Pin

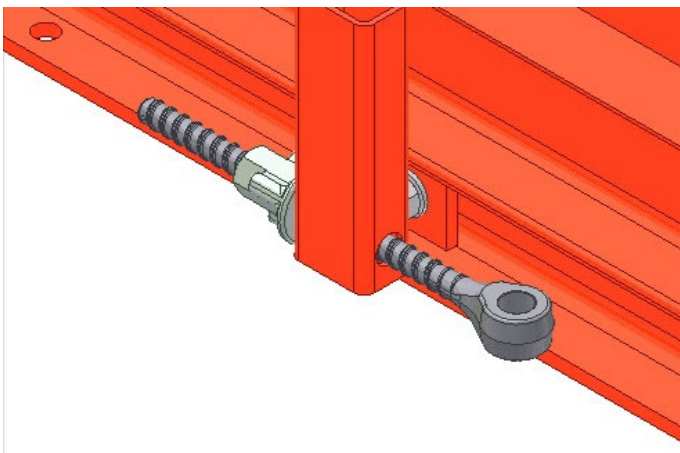

 037160 (Pin)  
 018060 (Cotter Pin )



13.10.90 Tie Yoke | Wing Nut

- Missing
  
- Or damaged due to force

 037150 (Tie Yoke)  
 030130 (Wing Nut)

 037150 (Tie Yoke)  
 030130 (Wing Nut)



# PERI Rental Criteria

## ACS 100











Strongback (051060; 051150)	Description	Instruction	Billing Condition	Type
	<b>13.10.91 U- Profile bent</b>			
	<ul style="list-style-type: none"> <li>■ If possible</li> </ul>			
	<ul style="list-style-type: none"> <li>■ Or if not possible</li> </ul>			
	<ul style="list-style-type: none"> <li>■ Or &gt; 10 mm (l/350)</li> </ul>			
	<b>13.10.92 Pin   Cotter Pin</b>			
	<ul style="list-style-type: none"> <li>■ Missing</li> </ul>	<ul style="list-style-type: none"> <li>715936 (Pin)</li> <li>018060 (Cotter Pin)</li> </ul>		
	<ul style="list-style-type: none"> <li>■ Or damaged due to force</li> </ul>	<ul style="list-style-type: none"> <li>715936 (Pin)</li> <li>018060 (Cotter Pin)</li> </ul>		

# PERI Rental Criteria

## ACS 100



Height Adjusting Unit (051030)	Description	Instruction	Billing Condition	Type
	<b>13.10.93 Spindle   Pin   Cotter Pin</b>	 106776 (Spindle) 715936 (Pin) 018060 (Cotter Pin)		
	<ul style="list-style-type: none"> <li>■ Or damaged due to force</li> </ul>	 106776 (Spindle) 715936 (Pin) 018060 (Cotter Pin)		
	<b>13.10.94 Brackets bent</b>			

# PERI Rental Criteria

## ACS 100



Adjustable Spindle Connector ACS-P (057099)	Description	Instruction	Billing Condition	Type
---	-------------	-------------	-------------------	------



13.10.95 Plaids bent



13.10.96 Pin | Cotter Pin

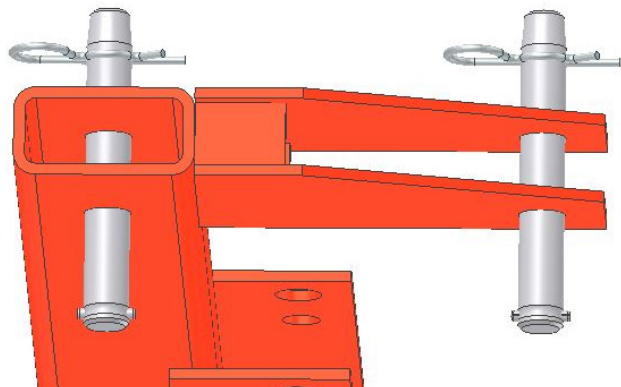

- Missing
- Or damaged due to force



715936 (Pin)  
022230 (Cotter Pin)



715936 (Pin)  
022230 (Cotter Pin)





# PERI Rental Criteria

## ACS 100



Strongback Connector-2 (051080)	Description	Instruction	Billing Condition	Type
	13.10.97 Hooks bent	710188 (Hook Right) 710186 (Hook Left)		
	13.10.98 T- Bolt damaged	710263 (T- Damaged)		
	13.10.99 Wing Nut damaged	710264 (Wing Nut)		

# PERI Rental Criteria

## ACS 100



Vertical Post Connector (057022)	No.	Name	Article Number
----------------------------------	-----	------	----------------

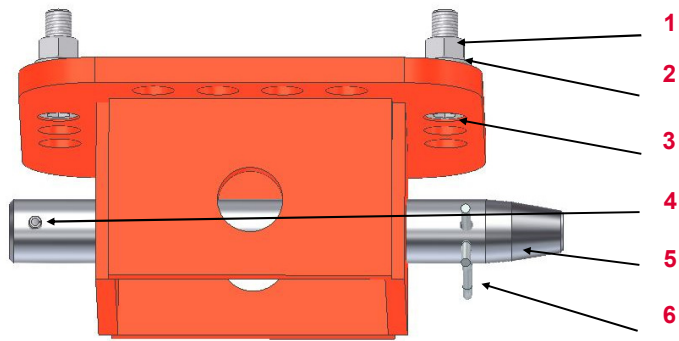

1	Nut M 20	710334
2	Washer	706454
3	Cylinder Bolt M 20 x 70	057121
4	Sleeve	722457
5	Pin	057120
6	Cotter Pin	710618

Damage	Description	Instruction	Billing Condition	Type
--------	-------------	-------------	-------------------	------

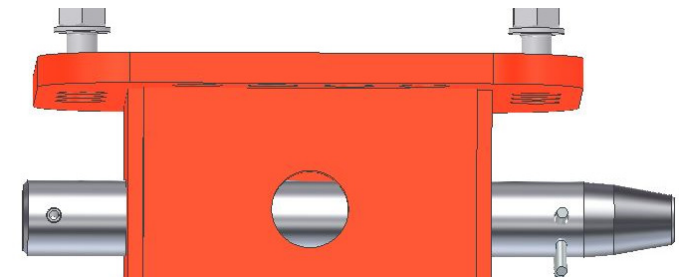

### 13.10.100 Pin | Cotter Pin | Bolts

- Missing
- Or damaged due to force

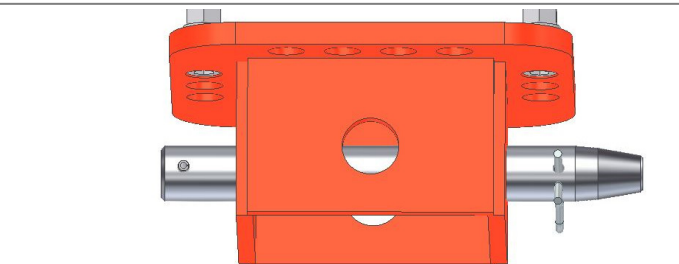

### 13.10.101 Bent

- If possible
- Or if not possible



# PERI Rental Criteria

## ACS 100



FP Post Connector ACS-P (057027)	No.	Name	Article Number
----------------------------------	-----	------	----------------

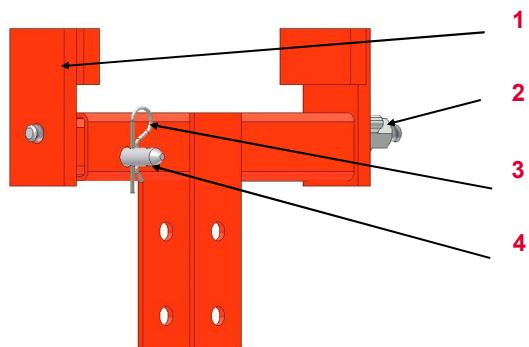

1	Adjusting Plate	057190
2	Wing Nut	030130
3	Cotter Pin 4/1	018060
4	Pin	018050

Damage	Description	Instruction	Billing Condition	Type
--------	-------------	-------------	-------------------	------

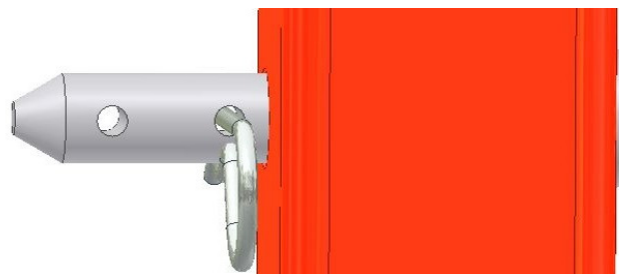

**13.10.102 Pin | Cotter Pin | Adjusting Plate**

- Missing
- Or damaged due to force

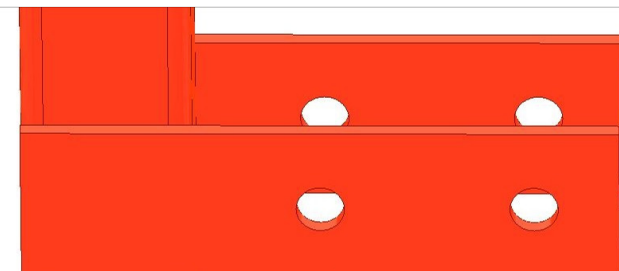

**13.10.103 Plaids bent**



# PERI Rental Criteria

## ACS 100



Girder Support ACS (057031)	Description	Instruction	Billing Condition	Type
	<b>13.10.104 Plaids</b>			
	■ Bent			
	■ Or crack in welding			
	■ Or missing			
	<b>13.10.105 Tube   Bolt   Nut</b>			
	■ Missing	057170 (Tube) 710049 (Bolt) 710229 (Nut)		
	■ Or damaged due to force	057170 (Tube) 710049 (Bolt) 710229 (Nut)		

# PERI Rental Criteria

## ACS 100



### Platform Post ACS

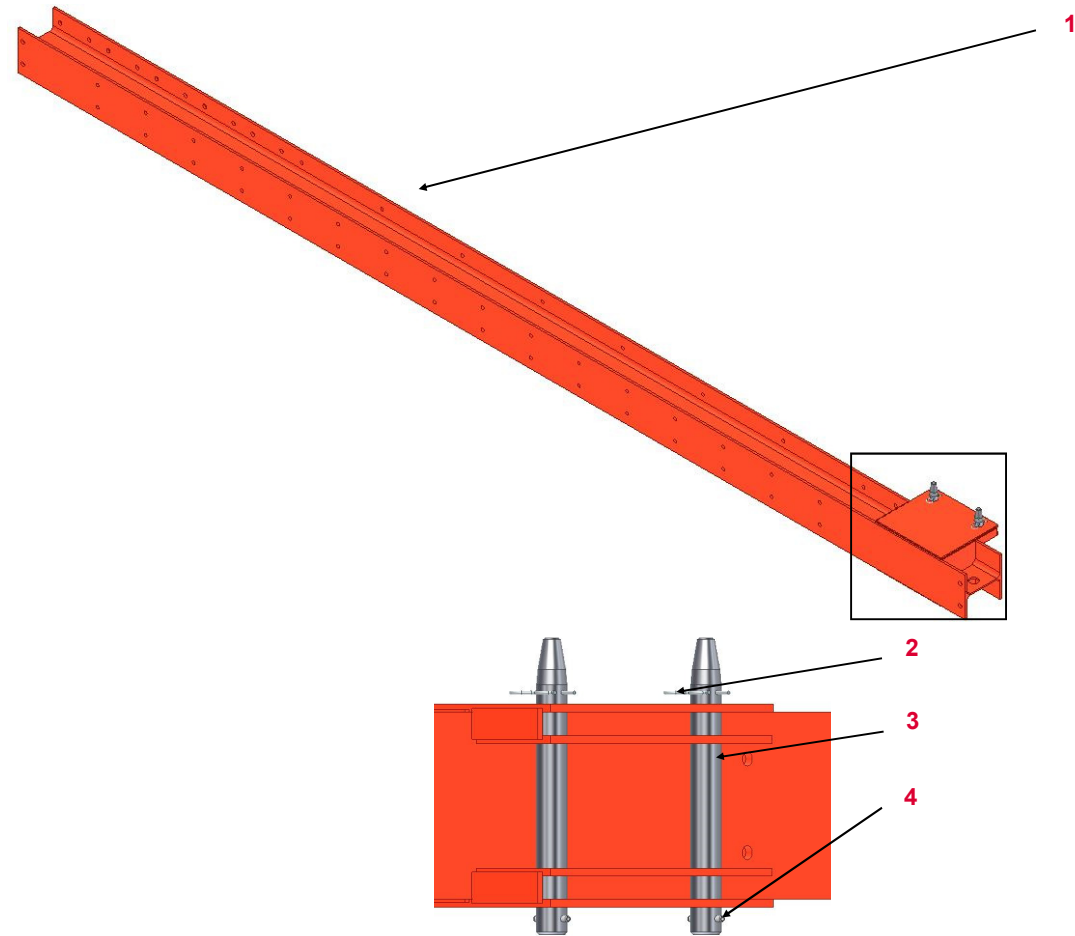

No.	Name	Article Number
1	Platform Post	
2	Cotter Pin 5/1	022230
3	Pin	057135
4	Sleeve	770012











#### Valid for

Platform Post 5900 HEA 240	057032
Platform Post 7100 HEA 240	057070
Platform Post 5900 HEA 200	057068
Platform Post 7100 HEA 200	057071
Platform Post 5900 HEA 160	057069

# PERI Rental Criteria

## ACS 100



Platform Post	Description	Instruction	Billing Condition	Type	
	<b>13.10.106 Assembly support cut off   deformed</b>				
	<b>13.10.107 Pin   Cotter Pin   Sleeve</b>	<ul style="list-style-type: none"> <li>■ Missing</li> </ul>			
	<ul style="list-style-type: none"> <li>■ Or damaged due to force</li> </ul>				

# PERI Rental Criteria

## ACS 100



Cantilever Platform Beam 870– 1170 (057072)	No.	Name	Article Number
---	-----	------	----------------

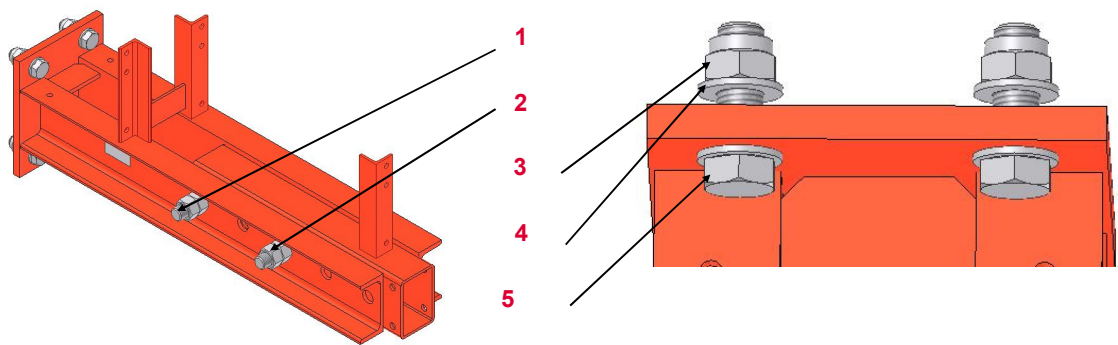

1	Bolt M 24	057138
2	Nut M 24	022250
3	Nut M 20	710334
4	Washer A 21	710454
5	Bolt M 20 x 60	057139

Damage	Description	Instruction	Billing Condition	Type
--------	-------------	-------------	-------------------	------

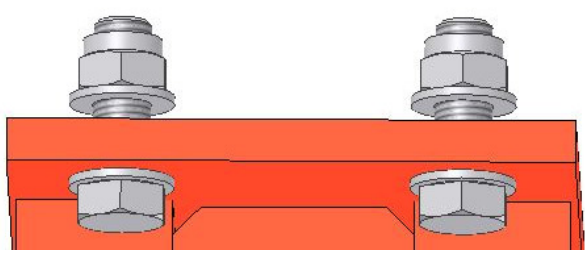

### 13.10.108 Bolts | Nuts

- Missing
- Or damaged due to force

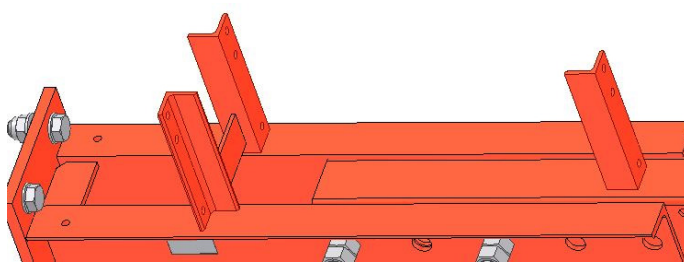

### 13.10.109 Plaids Bent

- If possible
- Or if not possible



# PERI Rental Criteria

## ACS 100



### Supporting Spindle ACS (057034)

No. Name Article Number

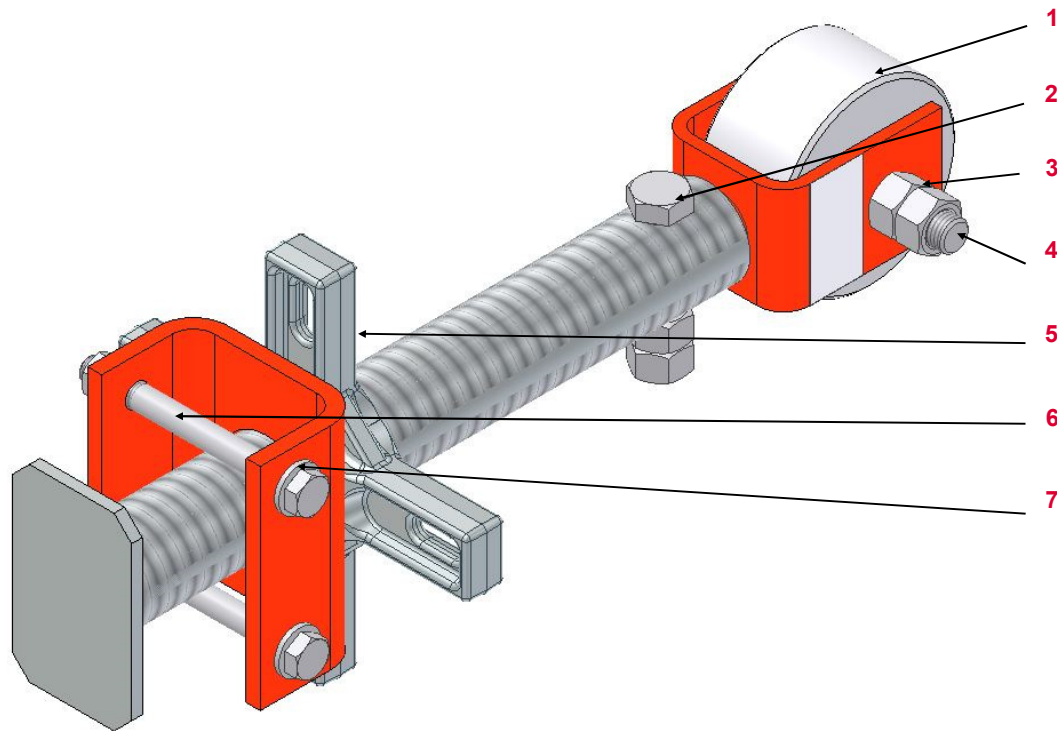











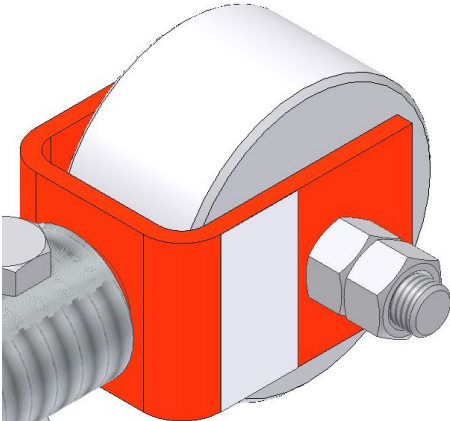

1	Roller 100– 50	057177
2	Bolt M 16 x 110	710233
3	Hex. Bolt M 16	710229
4	Bolt M 16 x 80	710222
5	Wingnut	710072
6	Bolt M 12 120	070100
7	Washer	780702

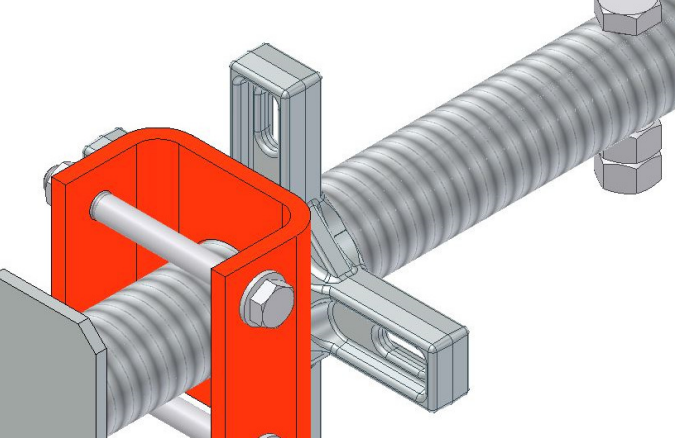

# PERI Rental Criteria

## ACS 100













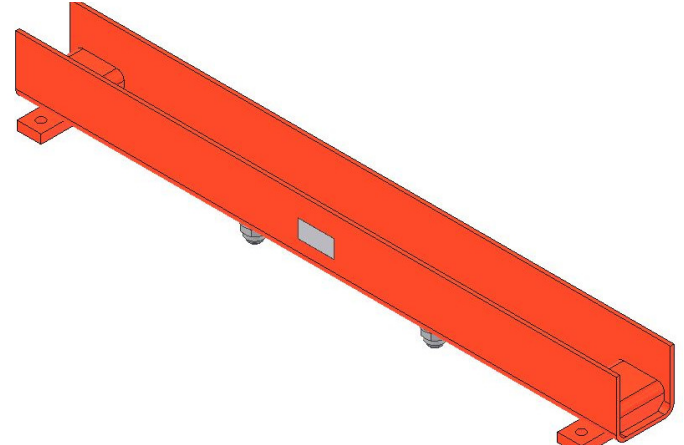

Supporting Spindle	Description	Instruction	Billing Condition	Type
	<b>13.10.110 Roller</b>			
	<ul style="list-style-type: none"> <li>■ Worn</li> </ul>			
	<ul style="list-style-type: none"> <li>■ Or damaged due to force</li> </ul>			
	<b>13.10.111 Parts</b>			
	<ul style="list-style-type: none"> <li>■ Missing</li> </ul>			
	<ul style="list-style-type: none"> <li>■ Or damaged due to force</li> </ul>			

# PERI Rental Criteria

## ACS 100



Beam Adapter (057063; 057064)	Description	Instruction	Billing Condition	Type
	<b>13.10.112 Bolts   Nuts</b>	<ul style="list-style-type: none"> <li>■ Missing                             <ul style="list-style-type: none"> <li>057139 (Bolt)</li> <li>710334 (Nut)</li> <li>706454 (Washer)</li> </ul> </li> </ul>		
	<ul style="list-style-type: none"> <li>■ Or damaged due to force</li> </ul>	<ul style="list-style-type: none"> <li>  <ul style="list-style-type: none"> <li>057139 (Bolt)</li> <li>710334 (Nut)</li> <li>706454 (Washer)</li> </ul> </li> </ul>		
	<b>13.10.113 Bent</b>	<ul style="list-style-type: none"> <li>■ If possible                             <ul style="list-style-type: none"> <li></li> </ul> </li> </ul>		
	<ul style="list-style-type: none"> <li>■ Or if not possible</li> </ul>	<ul style="list-style-type: none"> <li>  </li> </ul>		

# PERI Rental Criteria

## ACS 100



Panel Carrier Beam (057040   057389)	Description	Instruction	Billing Condition	Type
--------------------------------------	-------------	-------------	-------------------	------

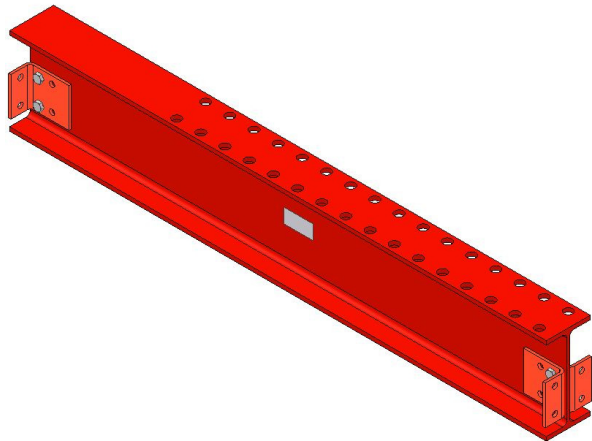

### 13.10.114 Bent

- If possible
- Or if not possible
- Or bend > 3 mm (L / 350)

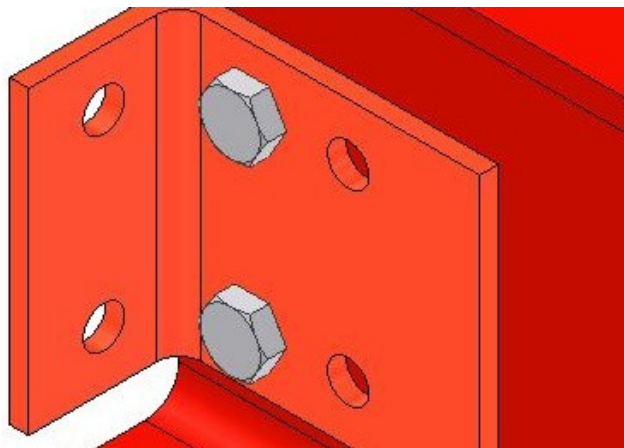

### 13.10.115 Trolley Stoppers bent

- If possible
- Or if not possible



057082 (Trolley Stopper)  
057264 (Bolt)  
710324 (Nut)



# PERI Rental Criteria

## ACS 100



Panel Suspension Tube VARIO 530 (057050)	Description	Instruction	Billing Condition	Type
--	-------------	-------------	-------------------	------



13.10.116 Tube bent

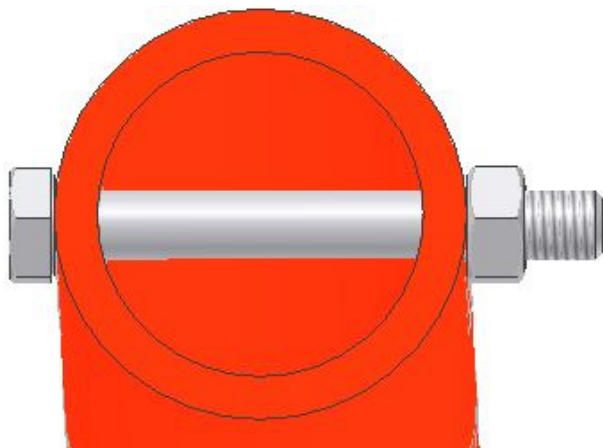

13.10.117 Bolt | Nut

- Missing
- Or damaged due to force



710593 (Bolt M 10 x 80)  
710234 (Nut)



# PERI Rental Criteria

## ACS 100



Panel Suspension Adapter (057049)	Description	Instruction	Billing Condition	Type
-----------------------------------	-------------	-------------	-------------------	------

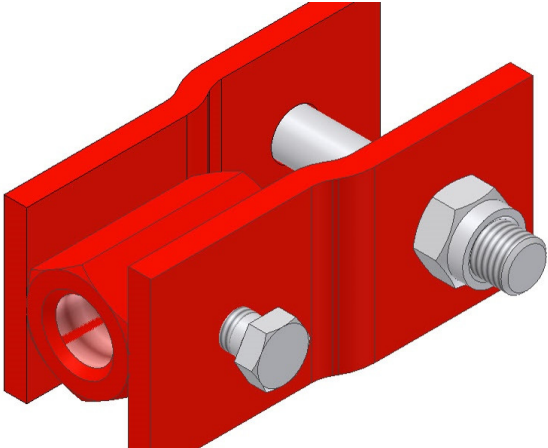

13.10.118 Bolts | Nuts missing

 721729 (Bolt M 16 x 90)  
 710266 (Bolt M 12 x 25)  
 070890 (Nut)

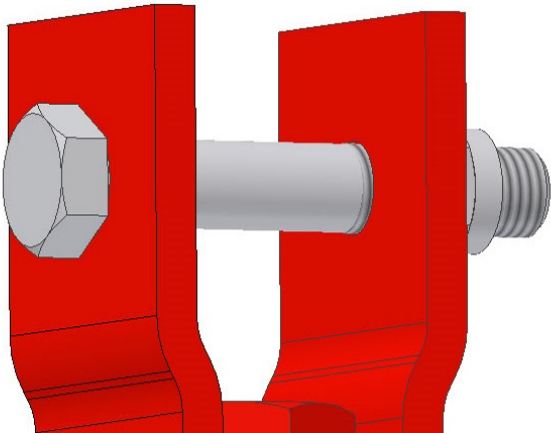

13.10.119 Brackets bent

■ If possible



■ Or if not possible



# PERI Rental Criteria

## ACS 100



Suspension for Corner Element ACS (057076)	Description	Instruction	Billing Condition	Type
--	-------------	-------------	-------------------	------

### 13.10.120 Bolt | Nut | Plaid

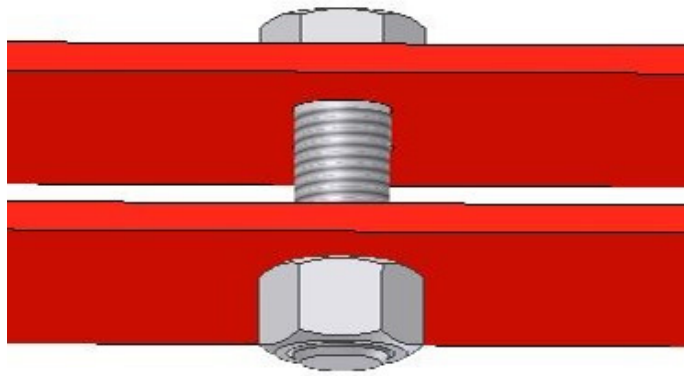

- Missing
- Or damaged due to force

 057244 (Plaid)  
 057139 (Bolt)  
 710334 (Nut)





 057244 (Plaid)  
 057139 (Bolt)  
 710334 (Nut)



### 13.10.121 Hex. Nut



- Thread not moveable











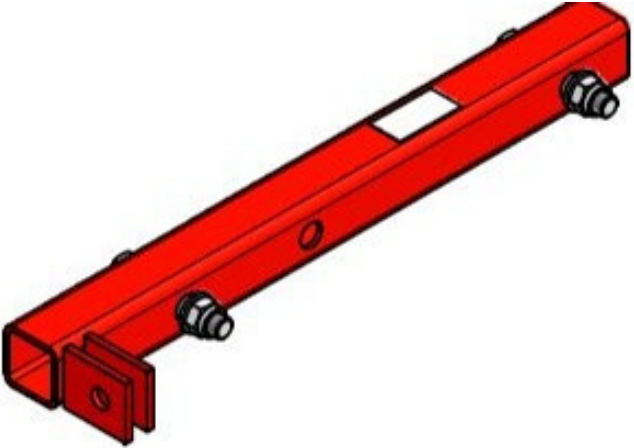

 030550 (Hex. Nut)

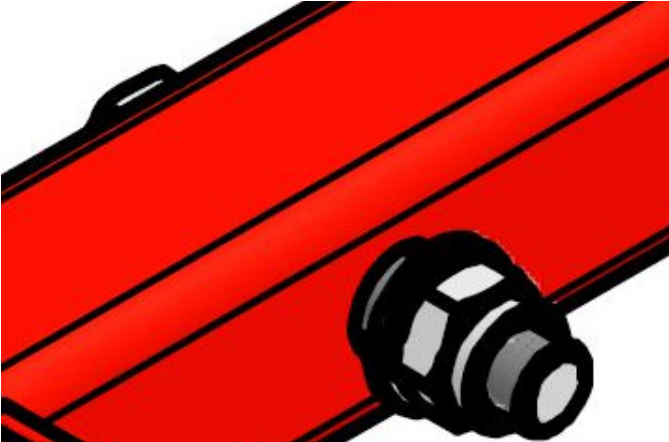

# PERI Rental Criteria

## ACS 100

















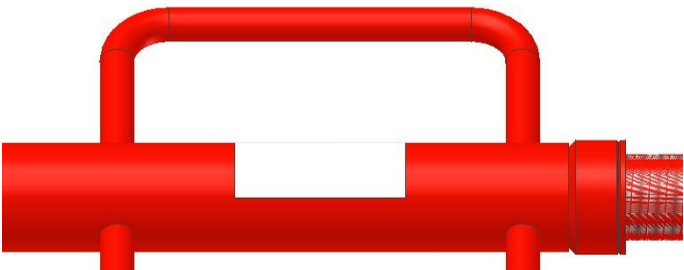

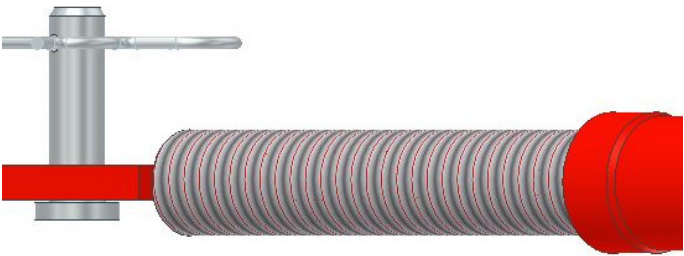

Connector AV (057051)	Description	Instruction	Billing Condition	Type
	13.10.122 Plaids bent	<ul style="list-style-type: none"> <li data-bbox="875 568 1279 593">■ If possible</li> </ul>		
	<ul style="list-style-type: none"> <li data-bbox="875 711 1279 737">■ Or if not possible</li> </ul>			
	13.10.123 Bolt   Nut	<ul style="list-style-type: none"> <li data-bbox="875 1072 1279 1098">■ Missing</li> </ul>		
	<ul style="list-style-type: none"> <li data-bbox="875 1216 1279 1241">■ Or damaged due to force</li> </ul>	<ul style="list-style-type: none"> <li data-bbox="1305 1200 1787 1289">            721729 (Bolt)            070890 (Nut)            711074 (Washer)         </li> </ul>		

# PERI Rental Criteria

## ACS 100



Kicker (057087; 057088; 028110)	Description	Instruction	Billing Condition	Type
	<b>13.10.124 Kicker bent</b>	<ul style="list-style-type: none"> <li>■ If possible</li> </ul>		
	<ul style="list-style-type: none"> <li>■ Or if not possible</li> </ul>			
	<b>13.10.125 Handle bent</b>	<ul style="list-style-type: none"> <li>■ If possible</li> </ul>		
	<ul style="list-style-type: none"> <li>■ Or if not possible</li> </ul>			
	<b>13.10.126 Spindle not possible</b>	<ul style="list-style-type: none"> <li>■ Weariness</li> </ul>		
	<ul style="list-style-type: none"> <li>■ Or damaged due to force</li> </ul>			



# PERI Rental Criteria

## ACS 100



Bracket ACS - G (057053)	Description	Instruction	Billing Condition	Type
--------------------------	-------------	-------------	-------------------	------



### 13.10.127 Worn

- $\leq 4$  mm  
And welding not damaged
- $> 4$  mm
- Or welding damaged

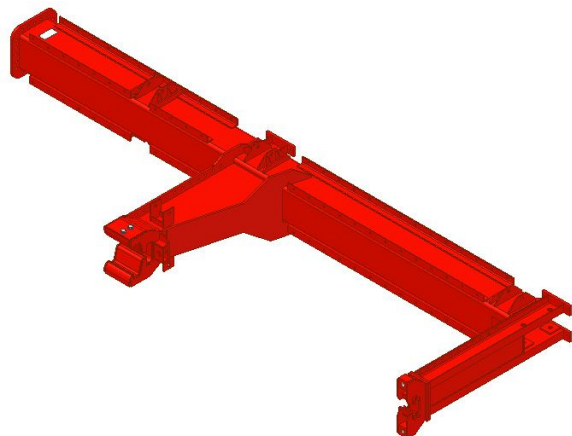

### 13.10.128 Plaids bent

- If possible
- Or if not possible



# PERI Rental Criteria

## ACS 100



Bracket ACS - G (057053)	Description	Instruction	Billing Condition	Type
	<b>13.10.129 Plaids bent</b>	<ul style="list-style-type: none"> <li>■ If possible</li> </ul>		
	<ul style="list-style-type: none"> <li>■ Or if not possible</li> </ul>			

# PERI Rental Criteria

## ACS 100



FP Post ACS - G (057055; 057056)	Description	Instruction	Billing Condition	Type
----------------------------------	-------------	-------------	-------------------	------

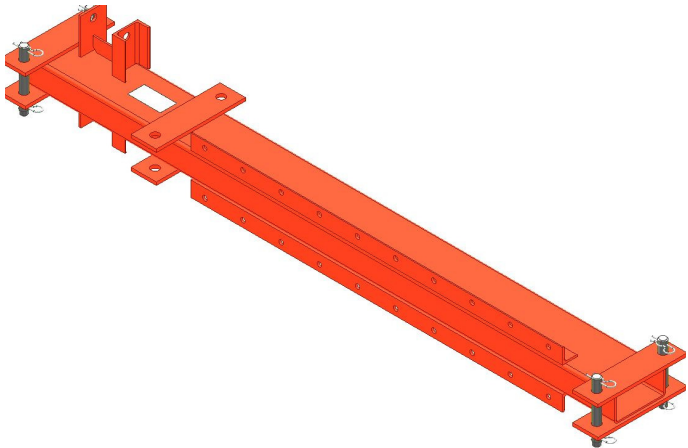

**13.10.130 Plaids bent**

■ If possible



■ Or if not possible

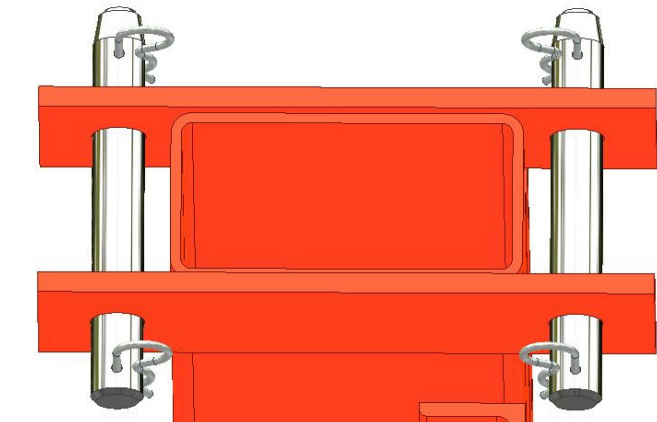

**13.10.131 Bolt | Cotter Pin**



706372 (Bolt)  
022230 (Cotter Pin)



# PERI Rental Criteria

## ACS 100



### Bracing DW 15 (057083)











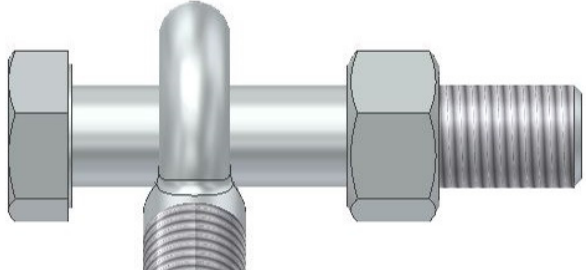









No.	Name	Article Number
1	Bolt M 20 x 100	024910
2	Eye Bolt	711060
3	Nut M 20	710334
4	Nut M 20	057263
5	Turnbuckle	711059
6	Tie Rod DW 15	701335
7	Nut SW 30	030090
8	Tie Yoke	037150

# PERI Rental Criteria

## ACS 100



Bracing DW 15 (057083)	Description	Instruction	Billing Condition	Type
	<b>13.10.132 Bolt   Nut</b>	<ul style="list-style-type: none"> <li>■ Missing</li> </ul>		
	<ul style="list-style-type: none"> <li>■ Or damaged due to force</li> </ul>			
	<b>13.10.133 Tie Yoke   Nut SW 30</b>	<ul style="list-style-type: none"> <li>■ Thread not moveable</li> </ul>		
	<ul style="list-style-type: none"> <li>■ Or soiled</li> </ul>			
	<b>13.10.134 Turnbuckle bent</b>	<ul style="list-style-type: none"> <li>■ Function given</li> </ul>		
	<ul style="list-style-type: none"> <li>■ Or if not given</li> </ul>			

# PERI Rental Criteria

## ACS 100



Distance Piece ACS (051736)	Description	Instruction	Billing Condition	Type
-----------------------------	-------------	-------------	-------------------	------



### 13.10.135 Shackle

- Bent
- Or damaged due to force



706451 (Shackle)



706451 (Shackle)

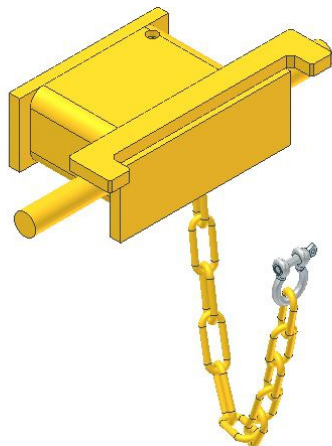

### 13.10.136 Bent













- If possible
- Or if not possible



# PERI Rental Criteria

## ACS 100



Distance Piece ACS (051736)	Description	Instruction	Billing Condition	Type
	<b>13.10.137 Chain</b>	<ul style="list-style-type: none"> <li>■ Bent</li> </ul>		
	<ul style="list-style-type: none"> <li>■ Or cracked</li> </ul>			
	<ul style="list-style-type: none"> <li>■ Or widend more than 10 %</li> </ul>			
	<b>13.10.138 Welding cracked</b>			

# PERI Rental Criteria

## ACS 100



Expander (051737)	Description	Instruction	Billing Condition	Type
-------------------	-------------	-------------	-------------------	------



13.10.139 Bent

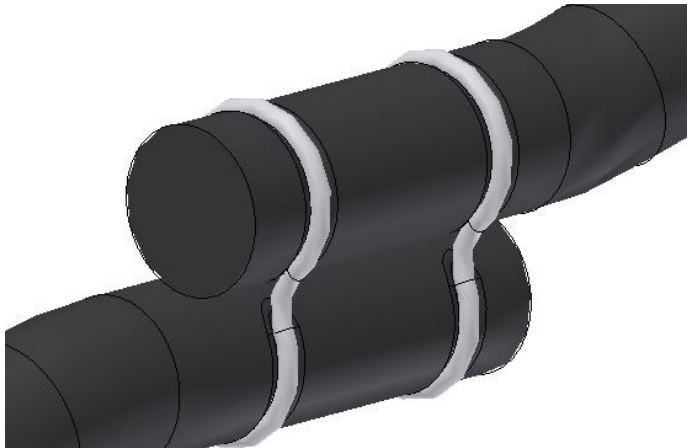

13.10.140 Connectors open





# PERI Rental Criteria

## ACS 100



Leading Anchor Plate (051730   051730)	Description	Instruction	Billing Condition	Type
--	-------------	-------------	-------------------	------



### 13.10.141 Bent

- If possible
- Or if not possible



### 13.10.142 Sleeve bent



# PERI Rental Criteria

## ACS 100



Climbing Cone (030920)	Description	Instruction	Billing Condition	Type
------------------------	-------------	-------------	-------------------	------



13.10.143 Bent



13.10.144 Thread not moveable

- Worn



- Or damaged due to force



# PERI Rental Criteria

## ACS 100



Climbing Cone (030920)	Description	Instruction	Billing Condition	Type
------------------------	-------------	-------------	-------------------	------



**13.10.145 Dowel Pin | Circlip | Cap missing**



710818 (Circlip)  
722615 (Dowel Pin)  
710107 (Cap)



**13.10.146 Cone Surface**

■ Scratches



■ Or rough



# PERI Rental Criteria

## ACS 100



### Trolley HTP ACS

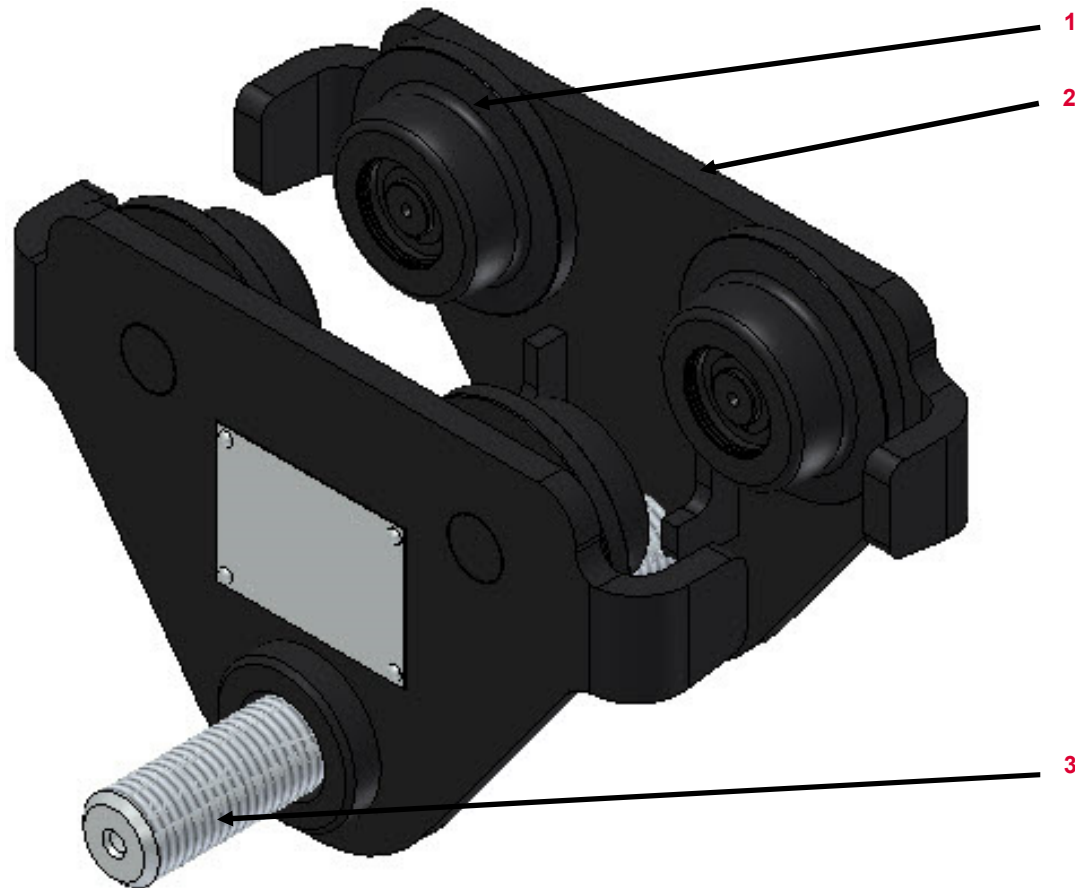

No.	Name	Article Number
1	Roller	
2	Side Plate	
3	Axis	

Valid for	
Trolley HTP 1000 kg, Gr.: A	057043
Trolley HTP 2000 kg, Gr.: A	057045
Trolley HTP 2000 kg, Gr.: B	057046

# PERI Rental Criteria

## ACS 100



Trolley (057043   057045   057046)	Description	Instruction	Billing Condition	Type
------------------------------------	-------------	-------------	-------------------	------

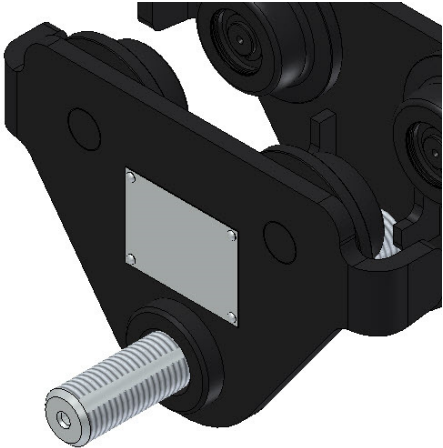

13.10.147 Side Plate | Axis bent



13.10.148 Roller







- Worn
- Or damaged due to force

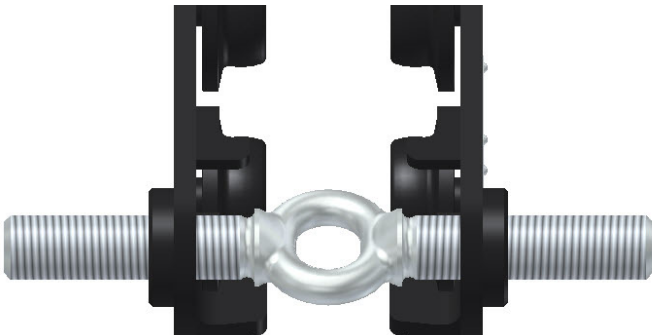

# PERI Rental Criteria

## ACS 100



Trolley (057043   057045   057046)	Description	Instruction	Billing Condition	Type
	<p><b>13.10.149 Spindle</b></p> <ul style="list-style-type: none"> <li>■ Worn</li> </ul>			
	<ul style="list-style-type: none"> <li>■ Or damaged due to force</li> </ul>			

# PERI Rental Criteria

## ACS 100



### Supporting Roller ACS (057417)

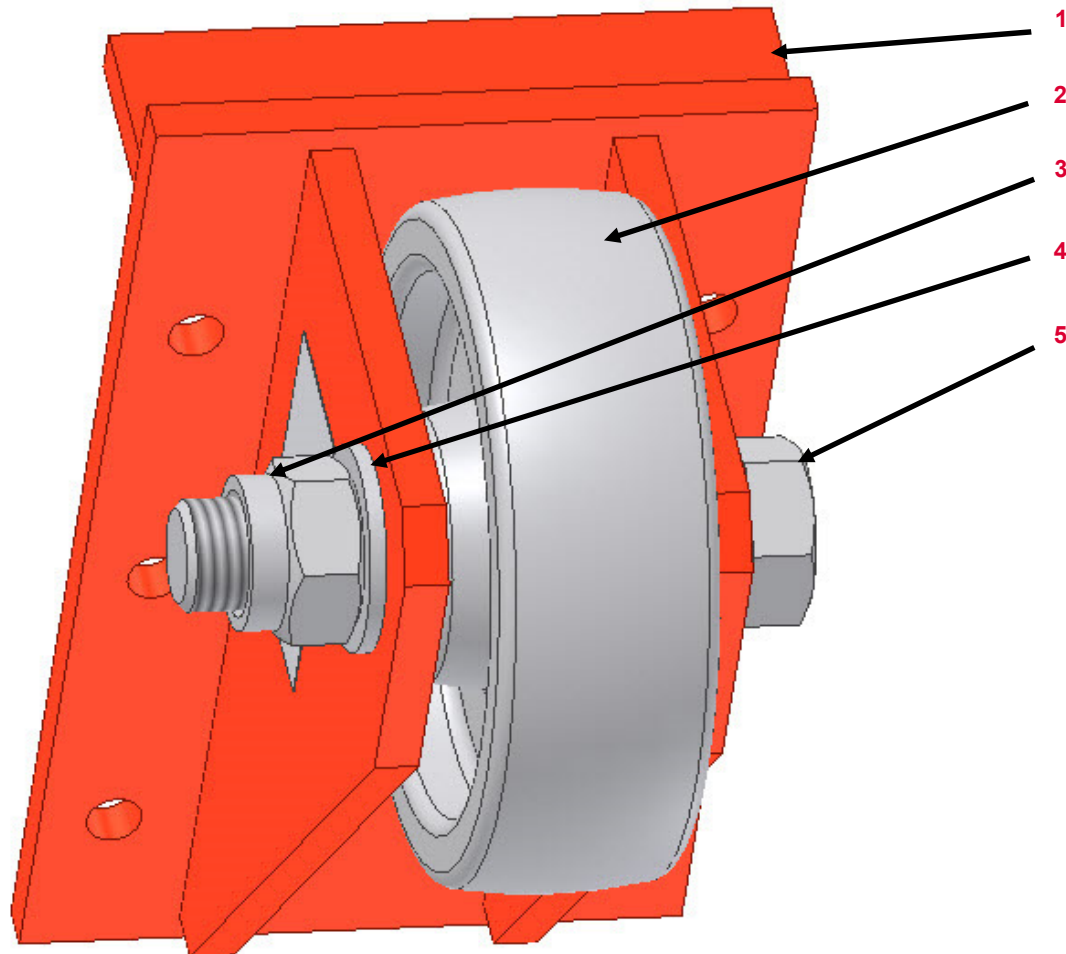









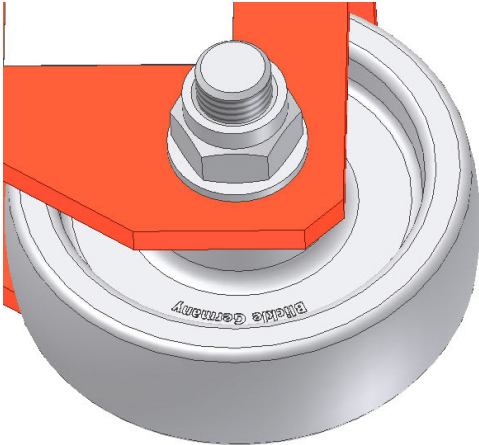





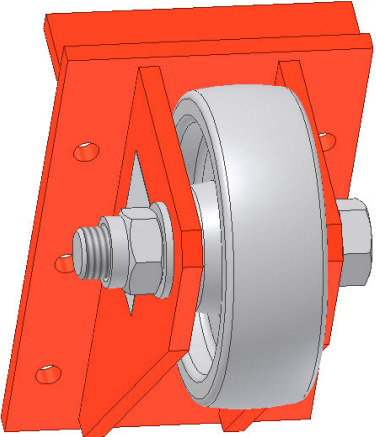

No.	Name	Article Number
1	Plate	057416
2	Roll	057414
3	Nut M20	781053
4	Washer	706454
5	Nut M 20 x 100	024910

# PERI Rental Criteria

## ACS 100



Supporting Roller (057417)	Description	Instruction	Billing Condition	Type
	<b>13.10.150 Roll</b>			
	<ul style="list-style-type: none"> <li>■ Worn</li> </ul>			
	<ul style="list-style-type: none"> <li>■ Or damaged due to force</li> </ul>			
	<b>13.10.151 Parts bent</b>			
	<ul style="list-style-type: none"> <li>■ Roll moveable and welding not damaged</li> </ul>			
	<ul style="list-style-type: none"> <li>■ Or welding damaged</li> </ul>			
	<ul style="list-style-type: none"> <li>■ Or re-bending not possible</li> </ul>			



# PERI Rental Criteria

## ACS 100



Locking Bar ACS (051729)	Description	Instruction	Billing Condition	Type
--------------------------	-------------	-------------	-------------------	------



### 13.10.152 Shackle

- Missing
- Or damaged due to force



706451 (Shackle)



706451 (Shackle)

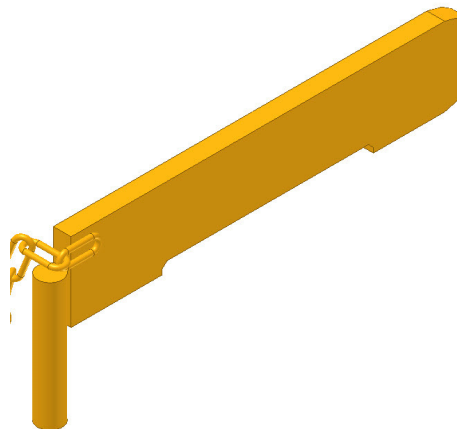













### 13.10.153 Bent



# PERI Rental Criteria

## ACS 100



Locking Bar ACS (051729)	Description	Instruction	Billing Condition	Type
	<b>13.10.154 Chain</b>	<ul style="list-style-type: none"> <li>■ Bent</li> </ul>		
	<ul style="list-style-type: none"> <li>■ Or cracked</li> </ul>			
	<ul style="list-style-type: none"> <li>■ Or widened more than 10 %</li> </ul>			
	<b>13.10.155 Welding cracked</b>			

# PERI Rental Criteria

## ACS 100



Clamp GT VT (057038; 057037)	Description	Instruction	Billing Condition	Type
------------------------------	-------------	-------------	-------------------	------

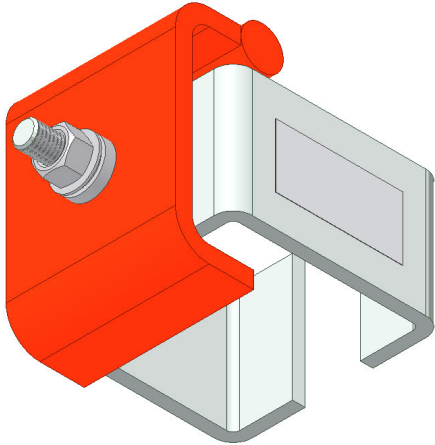

13.10.156 Bent (Clamping of girders not possible)

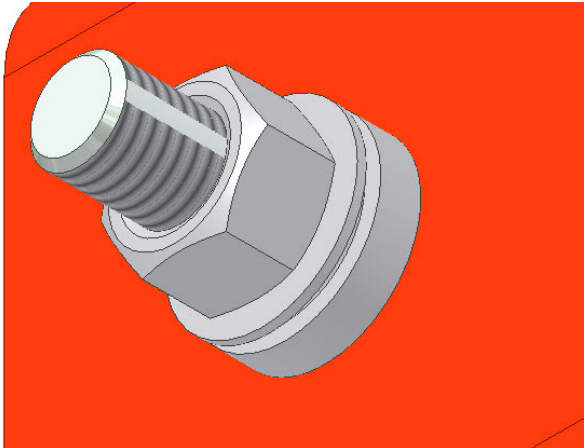

13.10.157 Nut | Spherical Disc | Conical Socket

- Missing



710330 (Nut)  
109112 (Spherical Disc)  
109113 (Conical Socket)











- Or damaged due to force

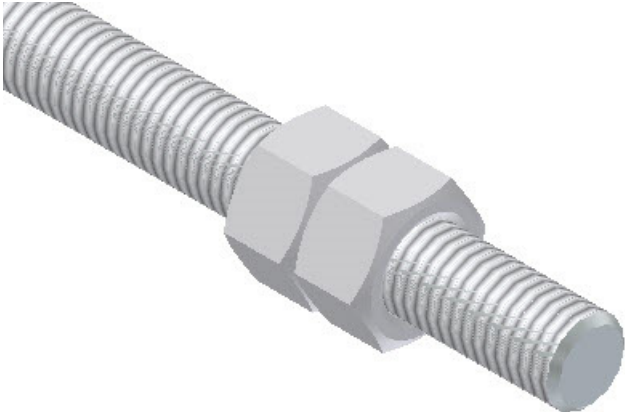

# PERI Rental Criteria

## ACS 100



Tension Strap (057794)	Description	Instruction	Billing Condition	Type	
	13.10.158 Strap bent				
	13.10.159 Nut missing		710330 (Nut)		

# PERI Rental Criteria

## ACS 100



Clamping Bolt (057026)	Description	Instruction	Billing Condition	Type
------------------------	-------------	-------------	-------------------	------

13.10.160 Bolt bent



13.10.161 Nut | Washer missing





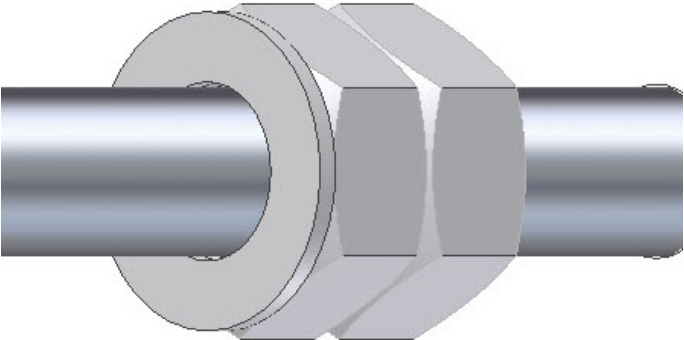







057126 (Nut)  
057127 (Washer)



# PERI Rental Criteria

## ACS 100



Compression Spindle M 42 (057054)	Description	Instruction	Billing Condition	Type
	<p><b>13.10.162 Spindle</b></p> <ul style="list-style-type: none"> <li>■ Not moveable</li> <li>■ Or bent</li> </ul>	<p>    </p>	<p>    </p>	<p>    </p>
	<p><b>13.10.163 Compression piece bent</b></p>	<p>  </p>	<p>  </p>	<p>  </p>

# PERI Rental Criteria

## ACS 100



### Vertical Strut 3075 ACS-P (057400)

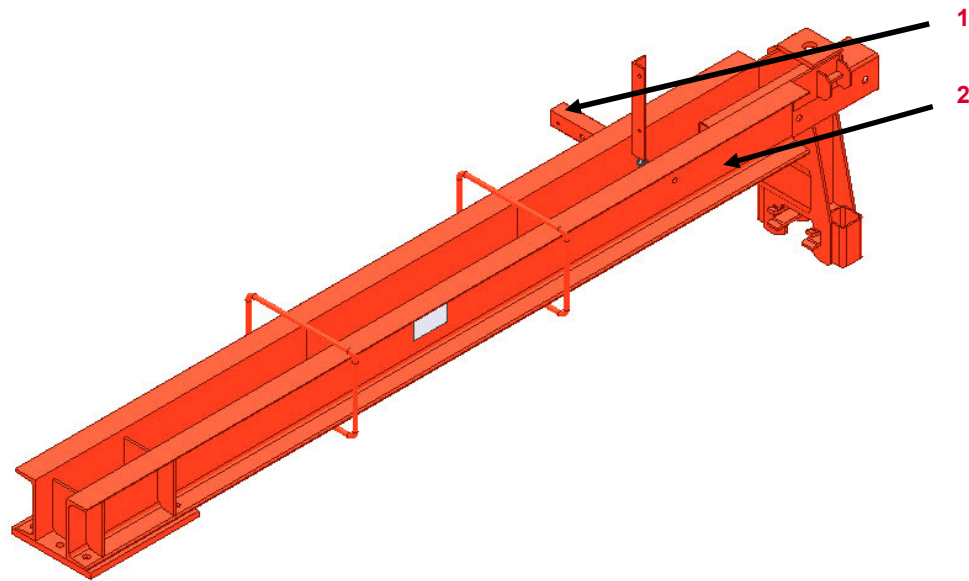

No.	Name	Article Number
1	„Podestauflage“	057397
2	Vertical Rod	
3	Washer	711074
4	Bolt M 16 x 45	710225
5	Nut	070890

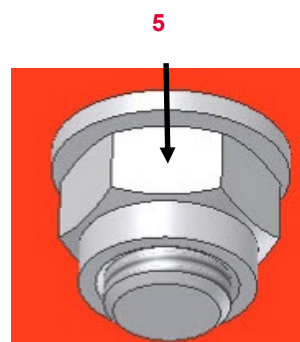
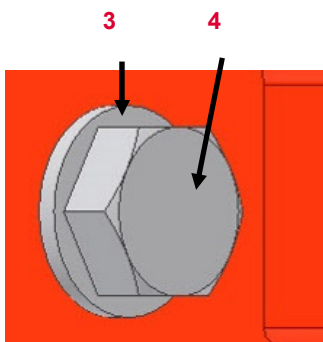

# PERI Rental Criteria

## ACS 100



Vertical Strut 3075 ACS-P	Description	Instruction	Billing Condition	Type
---------------------------	-------------	-------------	-------------------	------

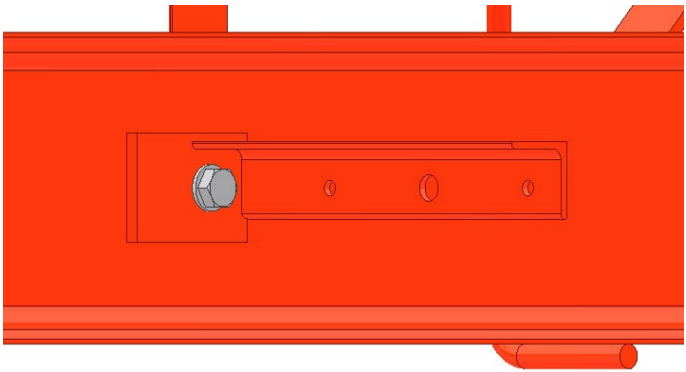

**13.10.164 „Podestauflage“**

- Missing



- Or bent

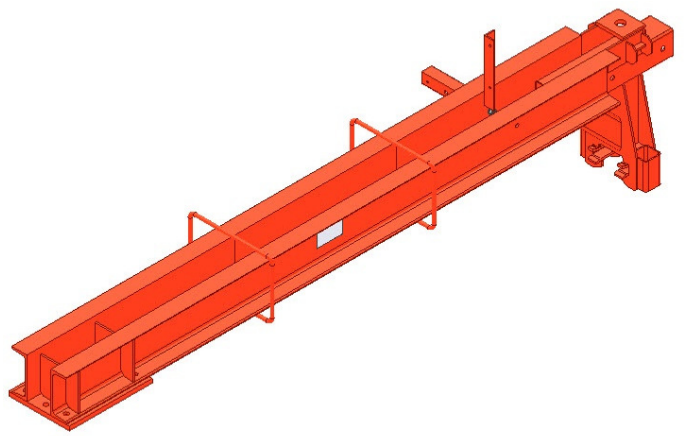

**13.10.165 Bent**

- > 8 mm (l/350)























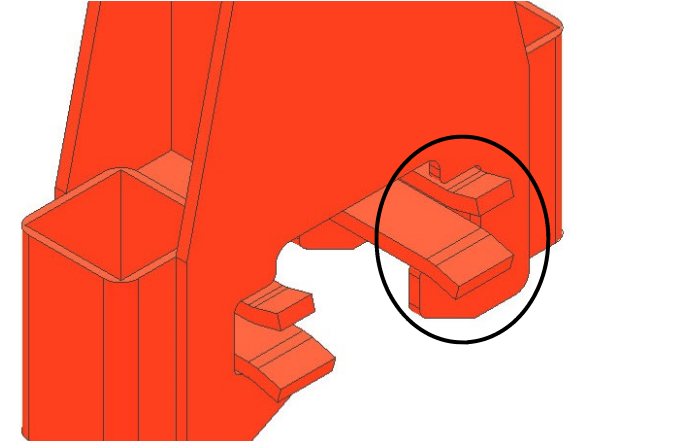





# PERI Rental Criteria

## ACS 100





















Vertical Strut 3075 ACS-P	Description	Instruction	Billing Condition	Type
	<b>13.10.166 Worn</b>	<ul style="list-style-type: none"> <li data-bbox="875 571 1294 632">■ ≤ 4 mm And welding not damaged</li> </ul>	  	
	<ul style="list-style-type: none"> <li data-bbox="875 743 1294 772">■ &gt; 4 mm</li> </ul>	   		
	<ul style="list-style-type: none"> <li data-bbox="875 884 1294 912">■ Or welding damaged</li> </ul>	   		
	<b>13.10.167 Plaids bent</b>	<ul style="list-style-type: none"> <li data-bbox="875 1090 1294 1118">■ If possible</li> </ul>	  	
	<ul style="list-style-type: none"> <li data-bbox="875 1230 1294 1259">■ Or if not possible</li> </ul>	   		
	<ul style="list-style-type: none"> <li data-bbox="875 1370 1294 1399">■ Or welding affected</li> </ul>	   		

# PERI Rental Criteria

## Glossary Icons



Icon	Significance	Icon	Significance	Icon	Significance
	Not OK – Scrap		Compensation (customer)		Optical damage– it’s permitted to handle out
	OK— Article stays in Rental Park		No compensation		Functional damage– it’s permitted to handle out
	It’s <b>not</b> permitted to handle out the article because of security aspects		Shorten the article		Functional damage– it’s <b>not</b> permitted to handle out
	Repair according to Working Instruction		Mark article		Statically damage– it’s <b>not</b> permitted to handle out
	Fix article cold		Replace defect components		
	Repair after local profitability calculation		Replace missing components		
	Clean the article		Attention voltage– Repair must be carried out by electricians		