

# PERI Rental Criteria

## Pallets and Stacking devices

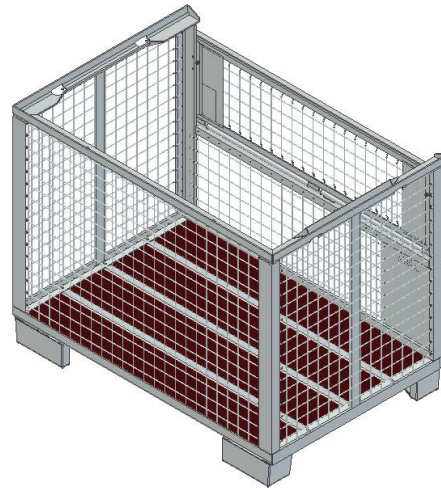

### Contact

**PERI GmbH**  
**Formwork Scaffolding**  
**Engineering**  
 P.O. Box 1264  
 89259 Weissenhorn, Germany  
 Phone +49 (0) 7309.950-0  
 Fax +49 (0) 7309.951-0  
 rental-criteria@peri.de

Content	Page	Changes made	Date   Initial	Page
Crate Pallet   Hardware Box	2	New version	10/2016   fw	
Palett RP- 2	8			
Pallet SD 150 x 225	14			
Palett ST 100-2	17			
Palett RP 110 x 125	21			
Palett SD	23			
Palett EP 110	25			
Frame Pallet USP 72   104	28			
Glossary	31			

# PERI Rental Criteria

## Pallets and Stacking devices



### Crate Pallet 80 x 120 | Hardware Box 80 x 120

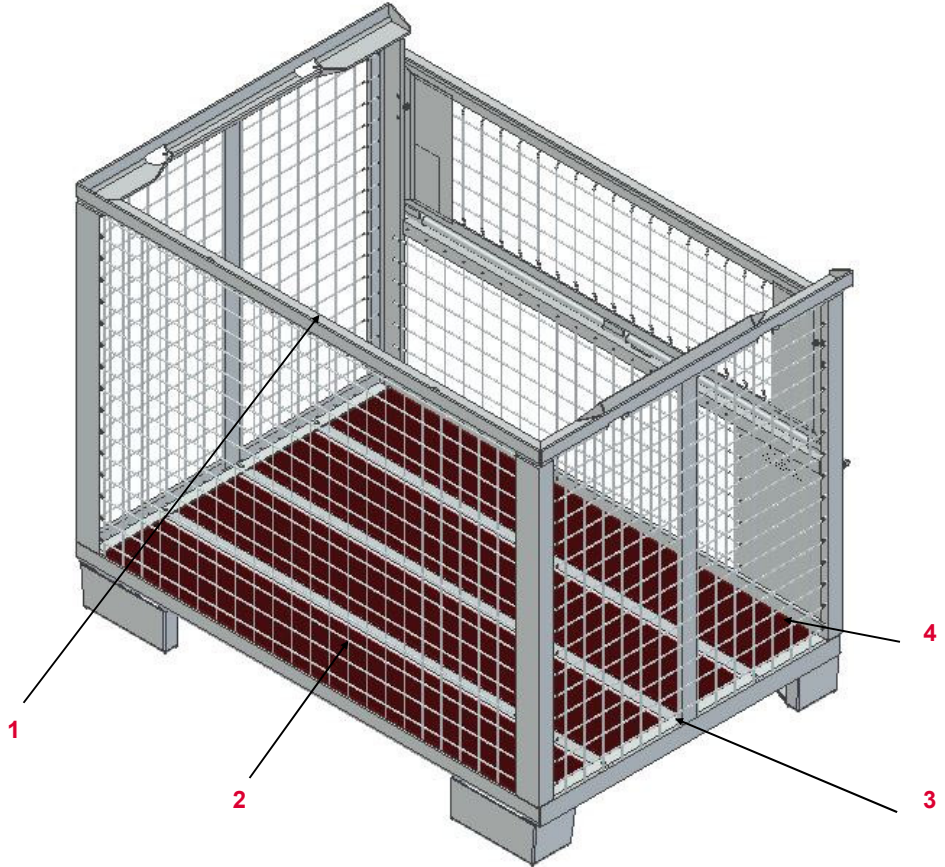

No.	Name	Article number
1	Frame	
2	Board 21 x 156 x 1192	721417
3	Board holder	720689
4	Rivet DIN 7337-A4, 8X12-ST	721412

Valid for	Article number
Crate Pallet 80 x 120, galv.	065068
Crate Pallet 80 x120-K, painted	065016
Hardware Box 80 x 120, galv.	025660
Hardware Box 80 x 120, painted	025670

# PERI Rental Criteria

## Pallets and Stacking devices



Crate Pallet   Hardware Box	Description	Instruction	Billing Condition	Type
-----------------------------	-------------	-------------	-------------------	------



32.01 Kinck in holm



# PERI Rental Criteria

## Pallets and Stacking devices



Crate Pallet   Hardware Box	Description	Instruction	Billing Condition	Type
-----------------------------	-------------	-------------	-------------------	------



32.02 Crate cracked

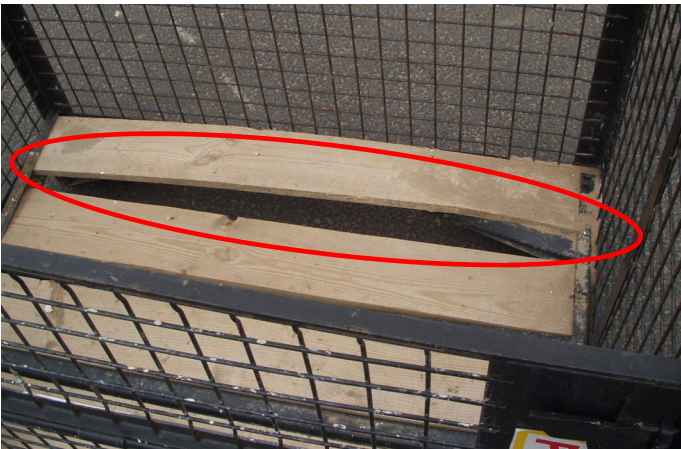

32.03 Board

- Worn



- Or damaged by force



# PERI Rental Criteria

## Pallets and Stacking devices



Crate Pallet   Hardware Box	Description	Instruction	Billing Condition	Type
	<p><b>32.04 Deformed closing flap</b></p> <ul style="list-style-type: none"> <li>■ Function not valid</li> </ul>			
	<p><b>32.05 Deformed feet</b></p> <ul style="list-style-type: none"> <li>■ Box don't stand straight</li> <li>■ Or secure stacking not possible</li> </ul>	 	 	 

# PERI Rental Criteria

## Pallets and Stacking devices



Crate Pallet   Hardware Box	Description	Instruction	Billing Condition	Type
-----------------------------	-------------	-------------	-------------------	------



32.06 Deformed crane eye



32.07 Type plate not readable















721400



# PERI Rental Criteria

## Pallets and Stacking devices



Crate Pallet   Hardware Box	Description	Instruction	Billing Condition	Type
	<b>32.08 Rusted</b>			
	<ul style="list-style-type: none"> <li>■ Material loss &lt; 10%</li> </ul>			
	<ul style="list-style-type: none"> <li>■ Or material loss &gt; 10%</li> </ul>	 		
<ul style="list-style-type: none"> <li>■ Or function not valid</li> </ul>	 			

# PERI Rental Criteria

## Pallets and Stacking devices



Palett RP-2 80 x 120   80 x 150 (103434   103429)	No.	Name	Article number
---	-----	------	----------------

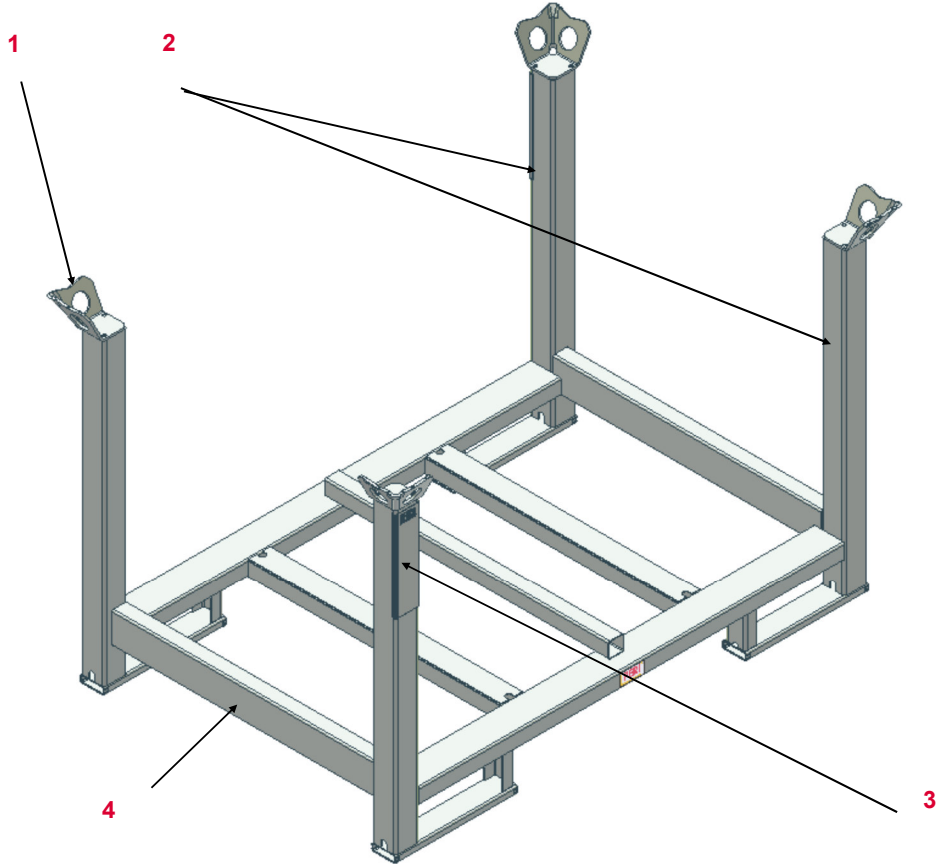

1	Crane eye
2	Holm left   right
3	Type plate
4	Horizontal tube



# PERI Rental Criteria

## Pallets and Stacking devices



Palett SD 150 x 75 (061500)	No.	Name	Article number
-----------------------------	-----	------	----------------

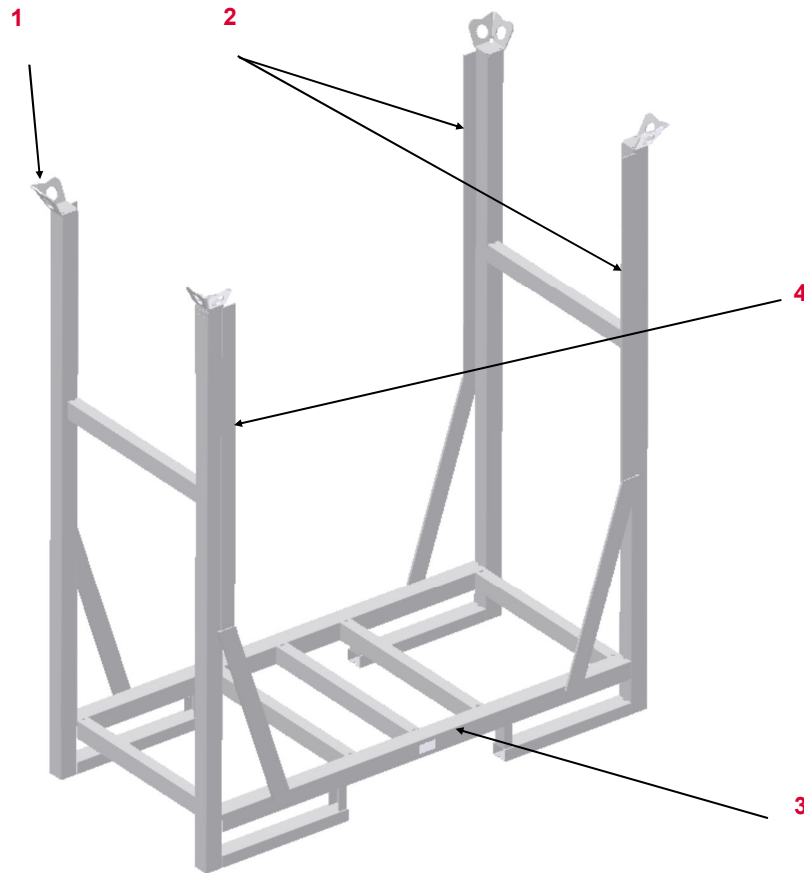

1	Crane eye
2	Holm left   right
3	Horizontal tube
4	Fail protection

# PERI Rental Criteria

## Pallets and Stacking devices



RP-2 80 x 120/150   SD 150 x 75	Description	Instruction	Billing Condition	Type
---------------------------------	-------------	-------------	-------------------	------



32.09 Crane eye bent | kink



32.10 Holm bent | kink



# PERI Rental Criteria

## Pallets and Stacking devices



RP-2 80 x 120/150   SD 150 x 75	Description	Instruction	Billing Condition	Type
---------------------------------	-------------	-------------	-------------------	------



### 32.11 Crane eye (photo version until 04/2011) worn

- In general: old version oval Crane eye | new version round crane eye
- Version until 04/2011:  
rest wall thickness  $\leq 16$  mm
- Or version since 04/2011:  
rest wall thickness  $\leq 15,7$  mm

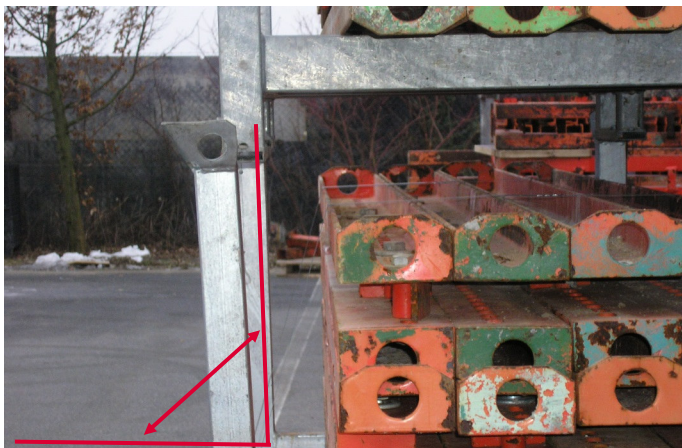

### 32.12 Holm bent

- Holmes bent  $> 1^\circ$



# PERI Rental Criteria

## Pallets and Stacking devices



RP-2 80 x 120/150   SD 150 x 75	Description	Instruction	Billing Condition	Type
---------------------------------	-------------	-------------	-------------------	------



32.13 Kink in the foot









32.14 Horizontal tube bent



# PERI Rental Criteria

## Pallets and Stacking devices



RP-2 80 x 120/150   SD 150 x 75	Description	Instruction	Billing Condition	Type
	<p><b>32.15 Crack in welding</b></p> <ul style="list-style-type: none"> <li>Without any damages of bordering components</li> </ul>			
	<ul style="list-style-type: none"> <li>Or with damages of bordering components</li> </ul>			

# PERI Rental Criteria

## Pallets and Stacking devices



Pallett SD 150 x 225 (061530)	No.	Name	Article number
-------------------------------	-----	------	----------------

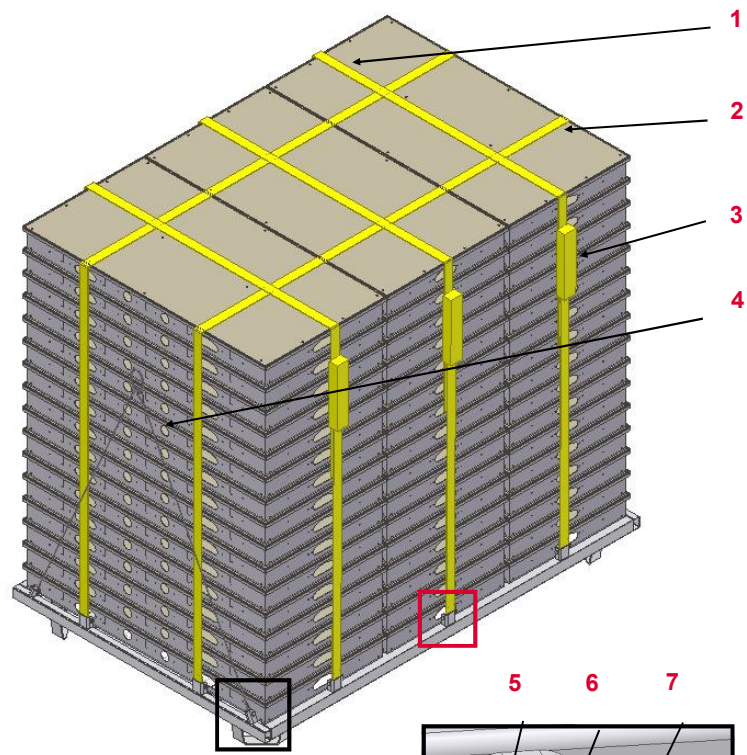

1	Belt L= 4200 Loose end	710595
2	Belt L= 5000 Loose End	710596
3	Belt with ratchet	710594
4	Robe	710597
5	Bolt M 10 x 50	710335
6	Tube L= 20	700372
7	Nut M 10	780356
8	Bolt M 10 x 80	710593
9	Bolt M 10	780356
10	Tube L = 53	700371

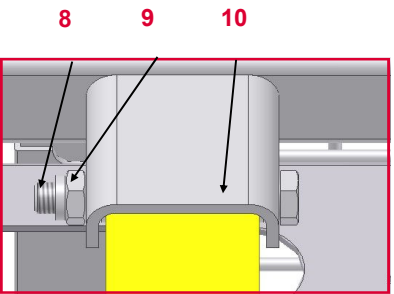
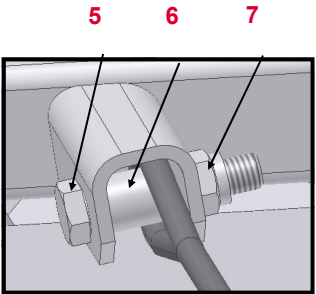

# PERI Rental Criteria

## Pallets and Stacking devices



SD 150 x 225	Description	Instruction	Billing Condition	Type
--------------	-------------	-------------	-------------------	------



**32.16 Belt | Rope**

- Missing
  
- Or damaged by force



710594 (Belt with ratchet)  
 710595 (Belt L= 4200)  
 710596 (Belt L= 5000)  
 710597 (Rope)



710594 (Belt with ratchet)  
 710595 (Belt L= 4200)  
 710596 (Belt L= 5000)  
 710597 (Rope)



# PERI Rental Criteria

## Pallets and Stacking devices



SD 150 x 225	Description	Instruction	Billing Condition	Type
--------------	-------------	-------------	-------------------	------

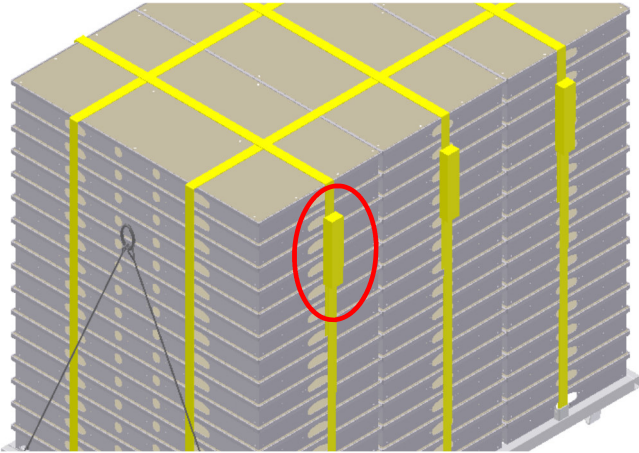

### 32.17 Lashing strap

- Function of ratchet not valid



710594 (Belt with ratchet)



### 32.18 Missing or non readable type plate of the lashing strap



710594  
710595  
710596





# PERI Rental Criteria

## Pallets and Stacking devices



Pallet ST 100-2 (065050)	No.	Name	Article number
--------------------------	-----	------	----------------

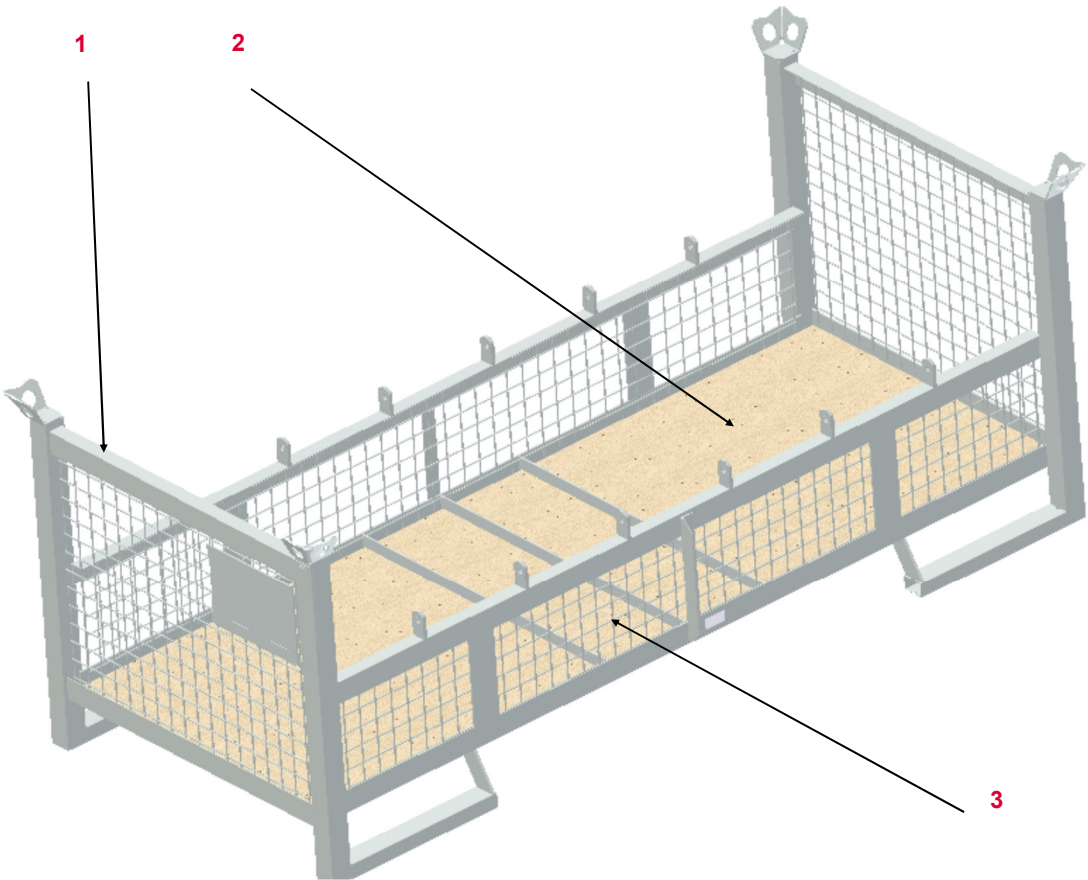

1	Pallet ST 100-2 verz.	106514
2	3-S-Plate 22mm 870x920	102353
3	3-S-Plate 22mm 870x240	102354

# PERI Rental Criteria

## Pallets and Stacking devices



Pallet ST 100-2	Description	Instruction	Billing Condition	Type
-----------------	-------------	-------------	-------------------	------



32.19 Kinck in holm



















32.20 Kink at the feet

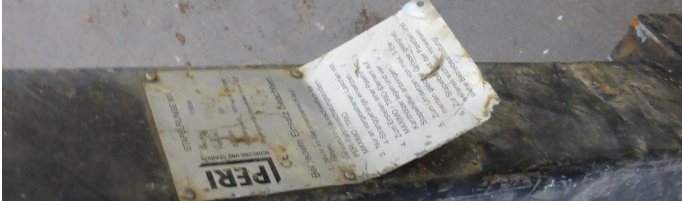

# PERI Rental Criteria

## Pallets and Stacking devices















Stacking device MX (115058)	Description	Instruction	Billing Condition	Type
	32.21 Profile bent			
	32.22 Crack in welding	 		
	32.23 Type plate not readable   missing			
	32.24 Bent	 Control of the weldings		

# PERI Rental Criteria

## Pallets and Stacking devices



DOMINO Stacking device (066094)	Description	Instruction	Billing Condition	Type
	<p><b>32.25 Crack in welding</b></p> <ul style="list-style-type: none"> <li>■ Damaged by force (Stacking device bent)</li> <li>■ Or damaged without force</li> </ul>	<p>   </p> <p>   </p>	<p>  </p> <p>  </p>	<p>  </p> <p>  </p>
	<p><b>32.26 Type plate not readable   missing</b></p>	<p>  </p> <p>750059 (Type plate) 710217 (Rivet)</p>	<p>  </p>	<p>  </p>

# PERI Rental Criteria

## Pallets and Stacking devices



Palett RP 110x125	No.	Name	Article number
-------------------	-----	------	----------------

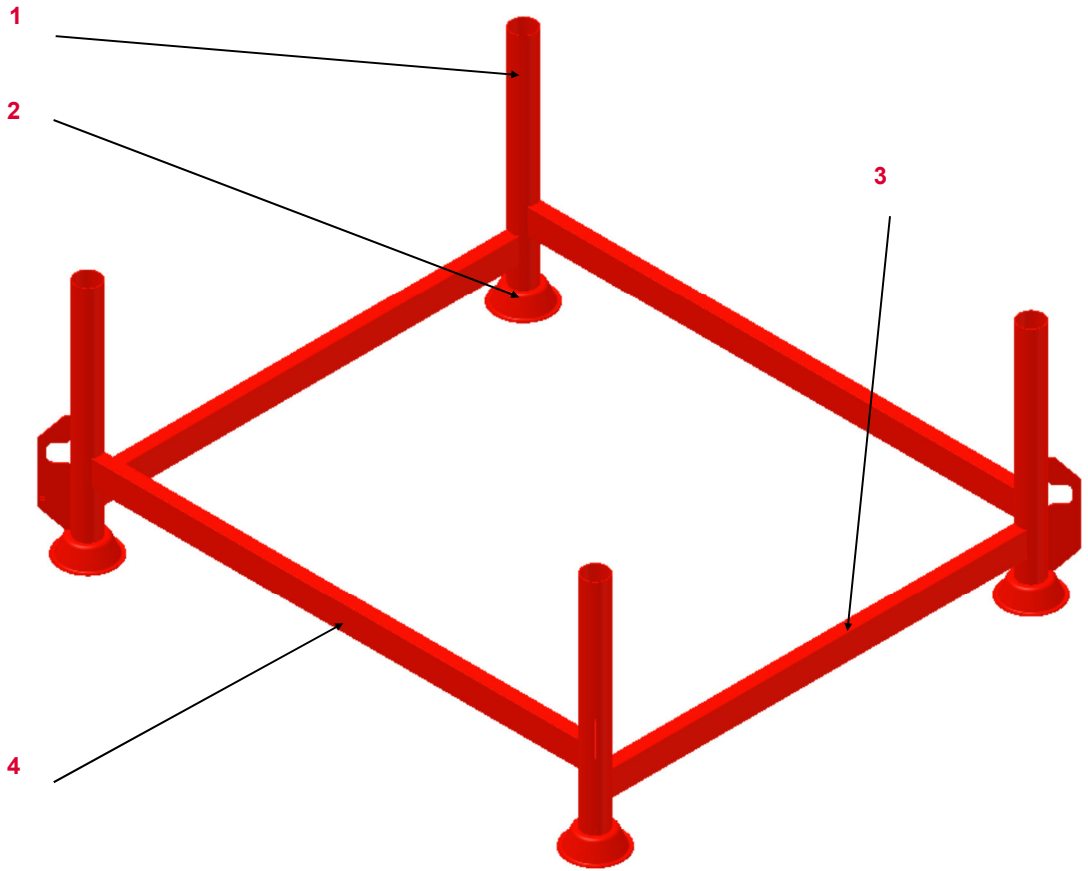

1	Holm
2	Stacking corner USP
3	Horizontal tube
4	Vertical tube

Valid for	Article number
Pallet RP 110x125 painted	106939
Pallet RP 80x110	111396

# PERI Rental Criteria

## Pallets and Stacking devices



Pallet RP 110x125   RP 80x110	Description	Instruction	Billing Condition	Type
-------------------------------	-------------	-------------	-------------------	------

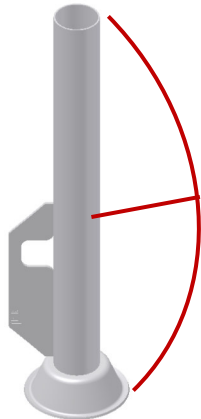

32.27 Holm bent | kink

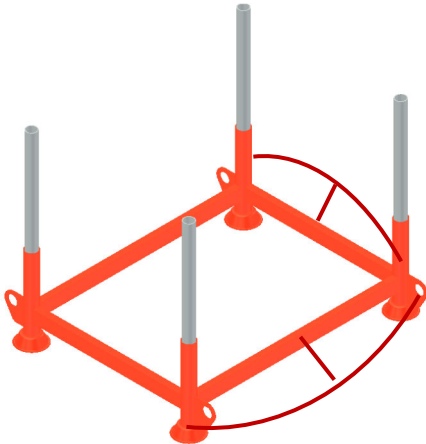

32.28 Horizontal | Vertical tube bent



# PERI Rental Criteria

## Pallets and Stacking devices



Pallet SD 75   150 (126630   126582)	No.	Name	Article number
--------------------------------------	-----	------	----------------

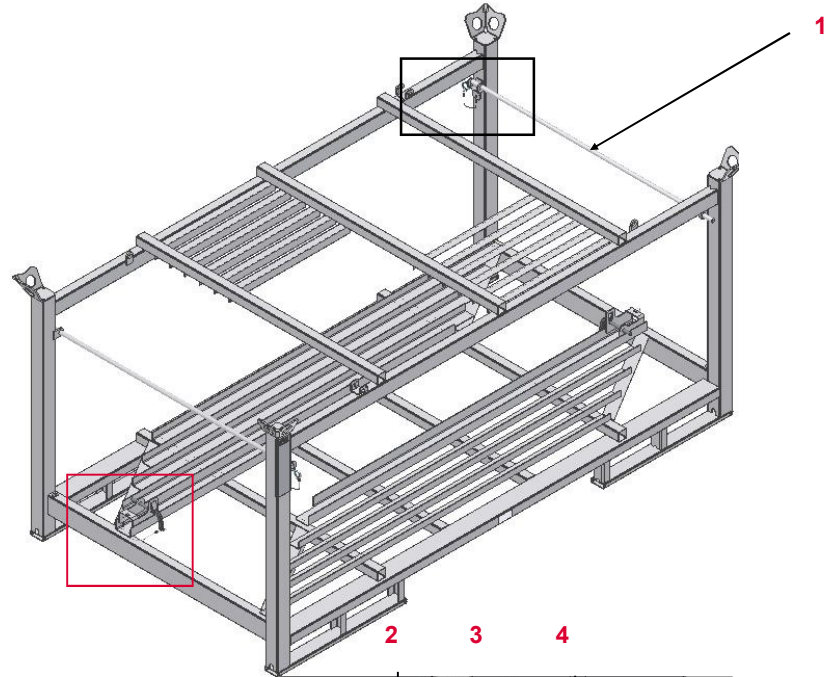

1	Protection stick	126618
2	Spring pin	125699
3	Ferrule	127302
4	Wire rope	127303
5	Locking pin	126638

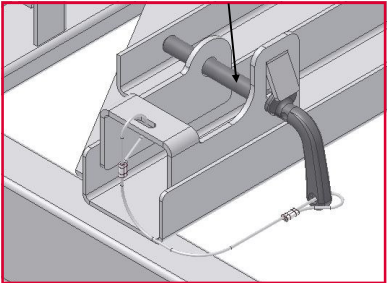
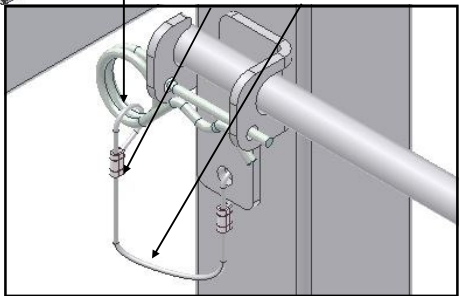

# PERI Rental Criteria

## Pallets and Stacking devices



Pallet SD 150 I 75	Description	Instruction	Billing Condition	Type
--------------------	-------------	-------------	-------------------	------

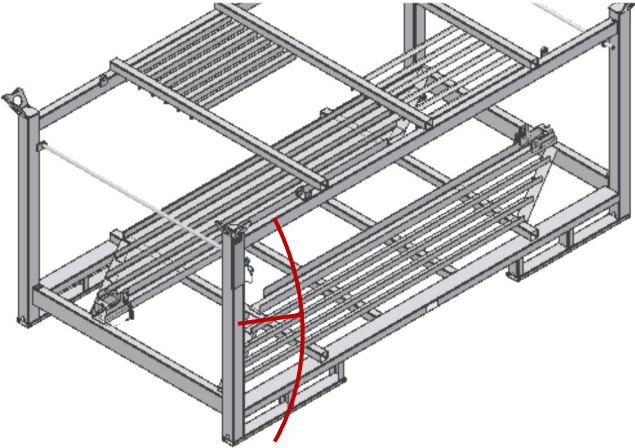

32.29 Kink in holm

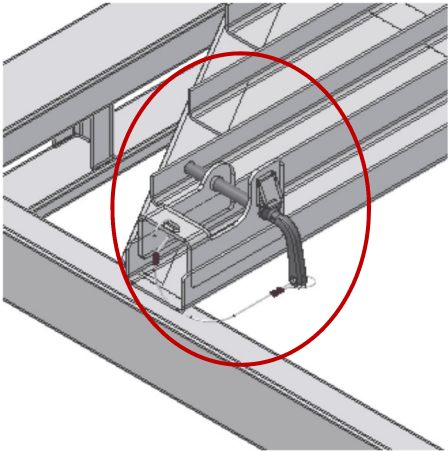

32.30 Locking pin missing



126638





# PERI Rental Criteria

## Pallets and Stacking devices



Pallet EP 110 (123960)	No.	Name	Article number
------------------------	-----	------	----------------

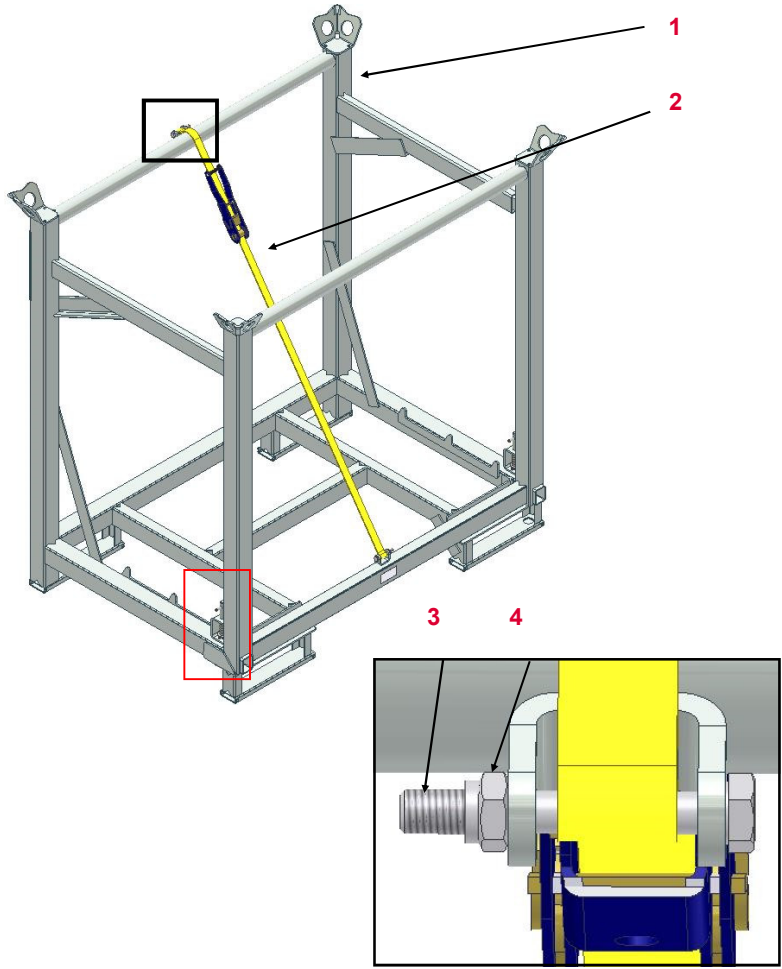

1	Pallet frame removable	123956
2	Lashing strap 25 x 2550	117560
3	Bolt M 8 x 60	710284
4	Nut M 8	711071
5	Spring	721816
6	Dowel pin	725186
7	Pin	123947
8	Washer	711074
9	Dowel pin	780807

# PERI Rental Criteria

## Pallets and Stacking devices



Pallet EP 110	Description	Instruction	Billing Condition	Type
---------------	-------------	-------------	-------------------	------



32.31 Crane eye bent

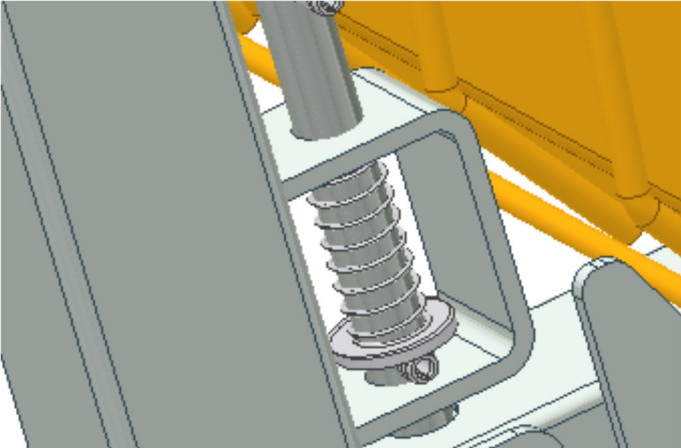

32.32 Pin

■ Missing



■ Or parts damaged



# PERI Rental Criteria

## Pallets and Stacking devices



Pallet EP 110	Description	Instruction	Billing Condition	Type
	<b>32.33 Lashing strap</b>			
	<ul style="list-style-type: none"> <li>■ Missing</li> </ul>	 117560		
<ul style="list-style-type: none"> <li>■ Or type plate not readable</li> </ul>	 117560			

# PERI Rental Criteria

## Pallets and Stacking devices



Frame Pallet USP 72   104 (100660   100678)	No.	Name	Article number
---	-----	------	----------------

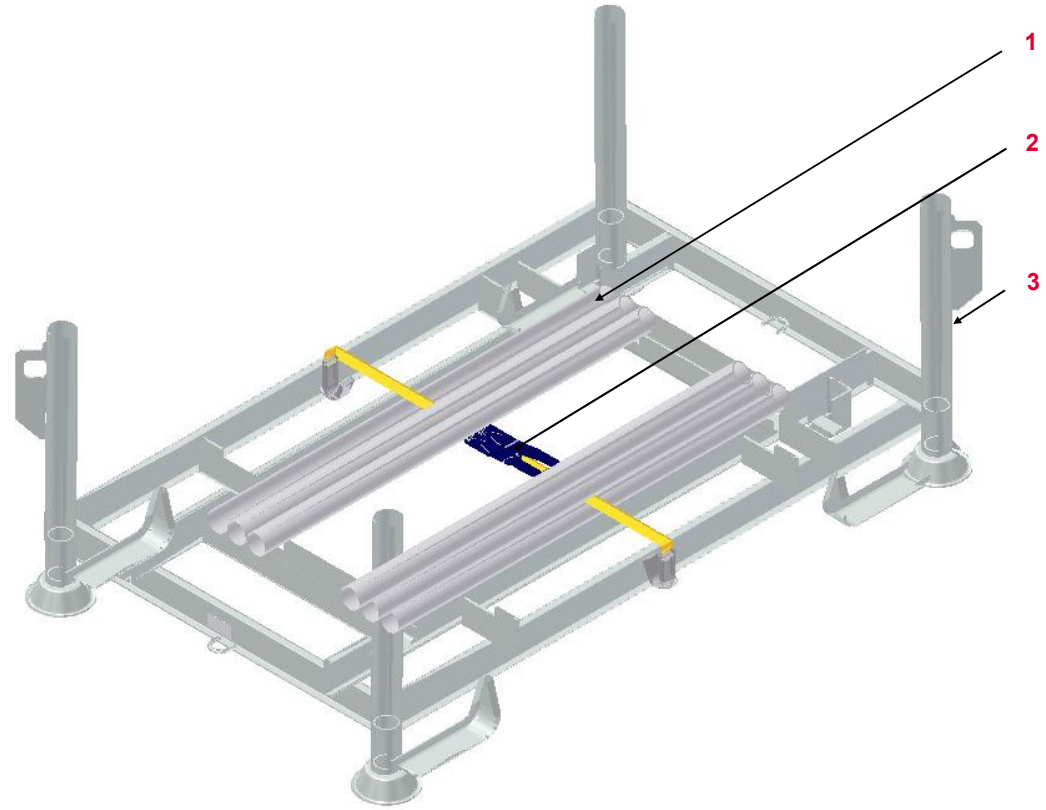









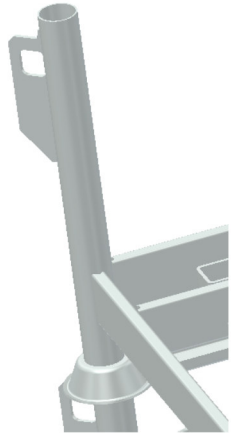



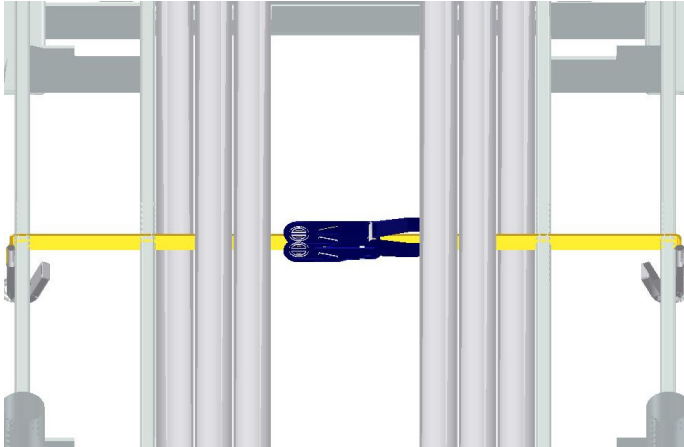

1	Tubes	100706
2	Lashing strap	100707
3	Holm	

# PERI Rental Criteria

## Pallets and Stacking devices





















Frame Pallet USP 72 / 104	Description	Instruction	Billing Condition	Type
	<p><b>32.34 Holm bent</b></p> <ul style="list-style-type: none"> <li>■ &gt; 1°</li> </ul>			
	<p><b>32.35 Lashing strap</b></p> <ul style="list-style-type: none"> <li>■ Damaged by force (e.g. cut in)</li> <li>■ Or missing</li> <li>■ Or worn</li> </ul>	<ul style="list-style-type: none"> <li> 100707</li> <li> 100707</li> <li> 100707</li> </ul>	<ul style="list-style-type: none"> <li></li> <li></li> <li></li> </ul>	<ul style="list-style-type: none"> <li></li> <li></li> <li></li> </ul>

# PERI Rental Criteria

## Pallets and Stacking devices



















Frame pallet USP 72 / 104	Description	Instruction	Billing Condition	Type
	<b>32.36 Tube</b>	<ul style="list-style-type: none"> <li>  100706                 </li> </ul>		
	<ul style="list-style-type: none"> <li>  Or damaged by force                 </li> </ul>	<ul style="list-style-type: none"> <li>  100706                 </li> </ul>		
	<b>32.37 Dent   kink in frame</b>	<ul style="list-style-type: none"> <li>  <ul style="list-style-type: none"> <li>  ≤ 5 mm deep                     </li> </ul> </li> </ul>		
	<ul style="list-style-type: none"> <li>  Or t &gt; 5 mm                 </li> </ul>	<ul style="list-style-type: none"> <li>  </li> </ul>		
	<ul style="list-style-type: none"> <li>  Or kink (e.g. made by fork lift)                 </li> </ul>	<ul style="list-style-type: none"> <li>  </li> </ul>		

# PERI Rental Criteria

## Glossary Icons



Icon	Significance	Icon	Significance	Icon	Significance
	Not Ok– material is scrap		Billing necessary (customer)		Optical damage
	OK– material stays in rental park		No Billing necessary		Functional damage
	Scrap material– it's not permitted to hand out the material because of safety aspects		Shorten the material		Functional damage— it's <b>not</b> permitted to hand out the material
	Repair according to instruction		Mark the material		Static damage— it's <b>not</b> permitted to hand out the material
	Fix material cold– Afterwards check weld seams and bordering components		Replace damaged material		
	Repair after local economic efficiency calculation		Replace missing material		
	Clean the material				