

# PERI Rental Criteria

## QUATTRO Column Formwork



### Contact

**PERI GmbH**  
**Formwork Scaffolding**  
**Engineering**

P. O. Box 1264  
 89259 Weißenhorn  
 Phone +49 (0) 7309.950-0  
 Fax +49 (0) 7309.951-0  
[rental-criteria@peri.de](mailto:rental-criteria@peri.de)

Content	Page	Change	Date   Initial	Page
Plate	2	New Version	10/2015   fw	
Frame	6			
Concreting platform	9			
Crane hook concreting platform	13			
Ladder 180/6	16			
Transportation wheel QUATTRO	17			
Column bolt set QUATTRO	18			
Brace connector QUATTRO	19			
Ladder connection QUATTRO	20			

# PERI Rental Criteria

## QUATTRO Column Formwork



### Column form QUATTRO

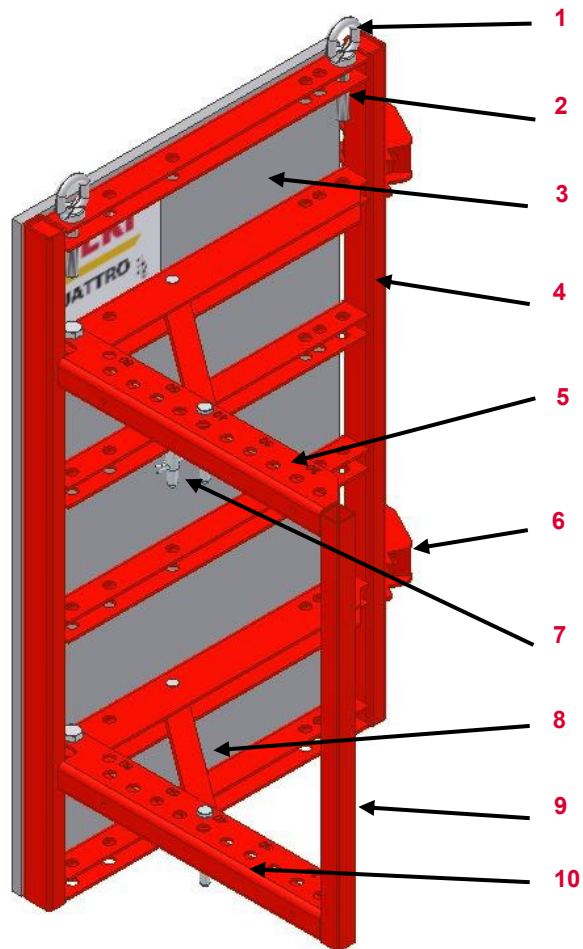















No.	Description	Article number
1	Ring bolt	724812
2	Hex nut M20	710045
3	SABO Plate	
4	Steel frame	
5	Rake	
6	Lager QE	724447
7	Pin	105400
8	„Riegelstrebe“ QE	725568
9	Rake profile	
10	Holes bolt QE	

Valid for	Artikelnummer
QUATTRO Element QES 125	109924
QUATTRO Element QES 275	109925
QUATTRO Element QES 350	109926
QUATTRO Element QES 50	109923

# PERI Rental Criteria

## QUATTRO Column Formwork











Plate	Description	Instruction	Billing Condition	Type
	<b>17.20.01 Nail holes</b>			
	<ul style="list-style-type: none"> <li>■ Nailed from front</li> </ul>	 Deburr with scraper		
	<ul style="list-style-type: none"> <li>■ Or nailed from behind</li> </ul>			
	<b>17.20.02 Holes</b>			
	<ul style="list-style-type: none"> <li>■ ≤ 35 mm</li> </ul>			
	<ul style="list-style-type: none"> <li>■ Or &gt; 35 mm</li> </ul>	 <ul style="list-style-type: none"> <li>SABO 500 mm (052164)</li> <li>SABO 1250 mm (052165)</li> <li>SABO 2750 mm (052166)</li> <li>SABO 3500 mm (052167)</li> </ul>	 <ul style="list-style-type: none"> <li>084223</li> <li>084222</li> <li>084221</li> <li>084220</li> </ul>	

# PERI Rental Criteria

## QUATTRO Column Formwork











Plate	Description	Instruction	Billing condition	Type
	<p><b>17.20.03 Notches/ scratches</b></p> <ul style="list-style-type: none"> <li>■ &gt; 1 mm depth</li> </ul>			
	<p><b>17.20.04 Edge damage</b></p> <ul style="list-style-type: none"> <li>■ &gt; 5 mm</li> </ul>			

# PERI Rental Criteria

## QUATTRO Column Formwork



Plate	Description	Instruction	Billing condition	Type
	<b>17.20.05 Damage by heat</b>	 SABO 500 mm (052164) SABO 1250 mm (052165) SABO 2750 mm (052166) SABO 3500 mm (052167)	 084223 084222 084221 084220	
	<b>17.20.06 Not removed pollution</b>	 SABO 500 mm (052164) SABO 1250 mm (052165) SABO 2750 mm (052166) SABO 3500 mm (052167)	 084223 084222 084221 084220	

# PERI Rental Criteria

## QUATTRO Column Formwork



Frame	Description	Instruction	Billing condition	Type
-------	-------------	-------------	-------------------	------

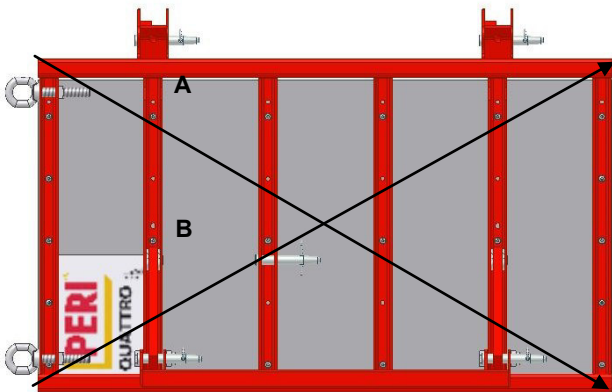

**17.20.07 Frame out of angle**

- Difference A to B > 10 mm

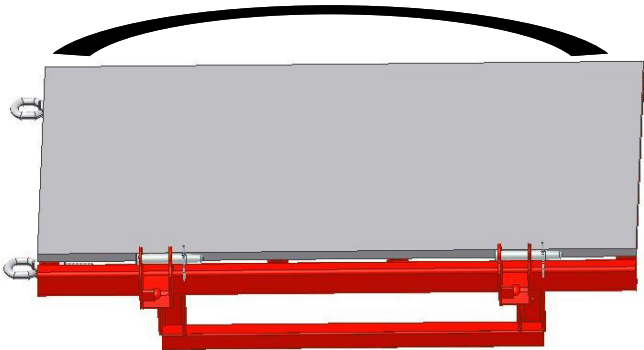

**17.20.08 Frame deformed**

- > 6 mm





# PERI Rental Criteria

## QUATTRO Column Formwork

















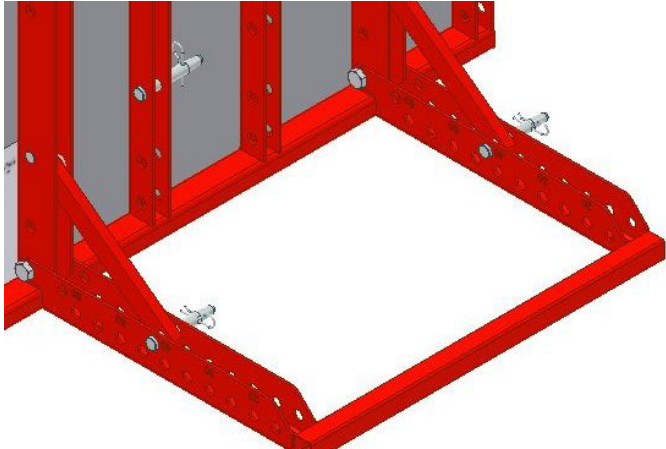

Frame	Description	Instruction	Billing condition	Type
<p><b>QE 125</b> <b>Rahmen verbogen</b></p>	<b>17.20.09 Cross profile bent</b>			
	<ul style="list-style-type: none"> <li>■ If possible</li> </ul>		088244	
	<ul style="list-style-type: none"> <li>■ Or if not possible</li> </ul>		0883589	
	<b>17.20.10 "Bodenblech" bent</b>			
	<ul style="list-style-type: none"> <li>■ If possible</li> </ul>		088244	
	<ul style="list-style-type: none"> <li>■ Or if not possible</li> </ul>		088292	

# PERI Rental Criteria

## QUATTRO Column Formwork



Frame	Description	Instruction	Billing condition	Type
	<b>17.20.11 Bearing QE bent</b>			
	<ul style="list-style-type: none"> <li>■ If possible</li> </ul>		 088244	
	<ul style="list-style-type: none"> <li>■ Or if not possible</li> </ul>			
	<b>17.20.12 Rake</b>			
	<ul style="list-style-type: none"> <li>■ Rake buckled or holes rooted up</li> </ul>		 088350 088354 088353	
	<ul style="list-style-type: none"> <li>■ Or rake buckled</li> </ul>		 088350 088354 088353	
	<ul style="list-style-type: none"> <li>■ Or rake profile buckled</li> </ul>		 088350 088354 088353	



# PERI Rental Criteria

## QUATTRO Column Formwork



Concreting platform (037400)	No.	Description	Article number
------------------------------	-----	-------------	----------------

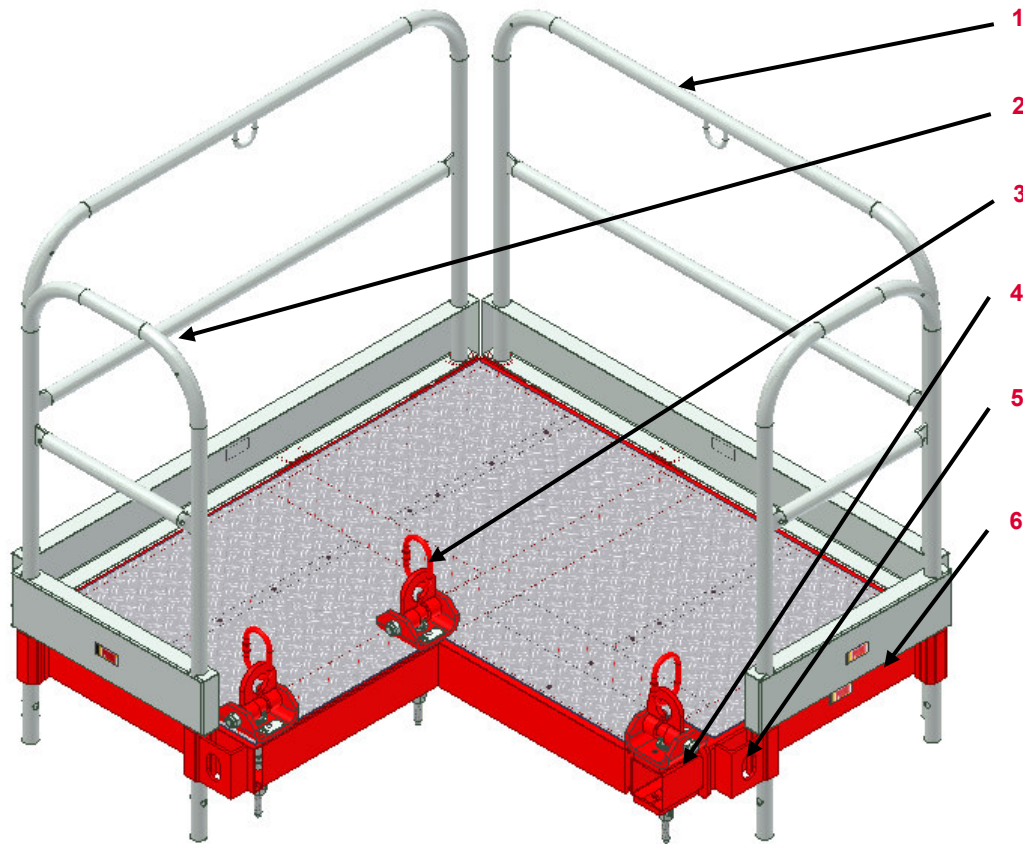









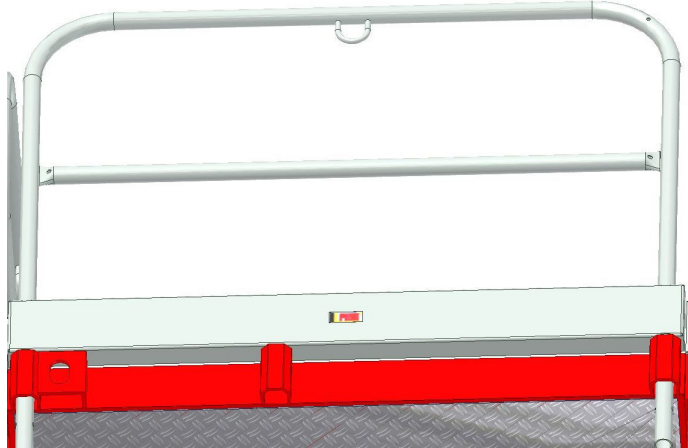





1	Platform Handrail 134	037430
2	Platform Handrail 52	037420
3	Crane hook	037440
4	Telescopic tube	786108
5	Handrail suspension	
6	Concreting landing	037410

# PERI Rental Criteria

## QUATTRO Column Formwork











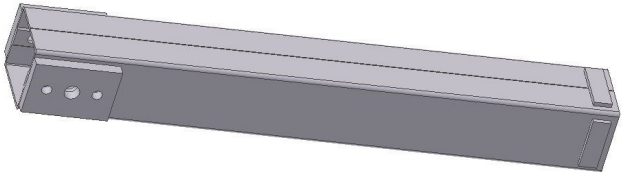

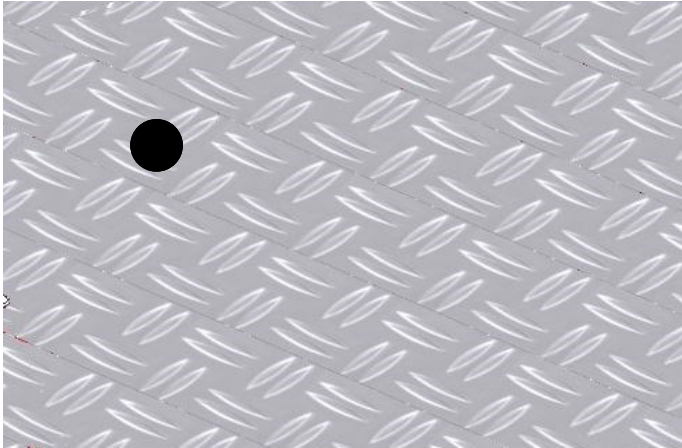

Concreting platform	Description	Instruction	Billing condition	Type
	<b>17.20.13 Handrail 134</b>	<ul style="list-style-type: none"> <li data-bbox="875 571 1010 598">■ Weld torn</li> </ul>	 Handrail 134(037430)  088590 	
	<ul style="list-style-type: none"> <li data-bbox="875 719 1025 746">■ Or buckeld</li> </ul>	 Handrail 134 (037430)  088590 		
	<b>17.20.14 Handrail 52</b>	<ul style="list-style-type: none"> <li data-bbox="875 1077 1010 1104">■ Weld torn</li> </ul>	 Handrail 52 (037420)  088589 	
	<ul style="list-style-type: none"> <li data-bbox="875 1225 1025 1252">■ Or buckeld</li> </ul>	 Handrail 52 (037420)  088589 		
				

# PERI Rental Criteria

## QUATTRO Column Formwork



Concreting platform	Description	Instruction	Billing Condition	Type
	<p><b>17.20.15 Telescopic tube</b></p> <ul style="list-style-type: none"> <li>■ Bent</li> </ul>	 Telescopic tube(786108)	 088582	
	<ul style="list-style-type: none"> <li>■ Or holes rooted up</li> </ul>	 Telescopic tube (786108)	 088582	
	<p><b>17.20.16 Hole in surface</b></p> <ul style="list-style-type: none"> <li>■ ≤ 30 mm</li> </ul>			
	<ul style="list-style-type: none"> <li>■ &gt; 30 mm</li> </ul>			

# PERI Rental Criteria

## QUATTRO Column Formwork



Concreting platform	Description	Instruction	Billing Condition	Type
	<p><b>17.20.17 Railing post</b></p> <ul style="list-style-type: none"> <li>■ Bent without crack in material or weld</li> </ul>		088244	
	<ul style="list-style-type: none"> <li>■ Bent with crack in material or weld</li> </ul>			
	<p><b>17.20.18 Baluster</b></p> <ul style="list-style-type: none"> <li>■ Bent without crack in material or weld</li> </ul>		088244	
	<ul style="list-style-type: none"> <li>■ Bent with crack in material or weld</li> </ul>			

# PERI Rental Criteria

## QUATTRO Column Formwork



### Crane eye concreting platform (037440)

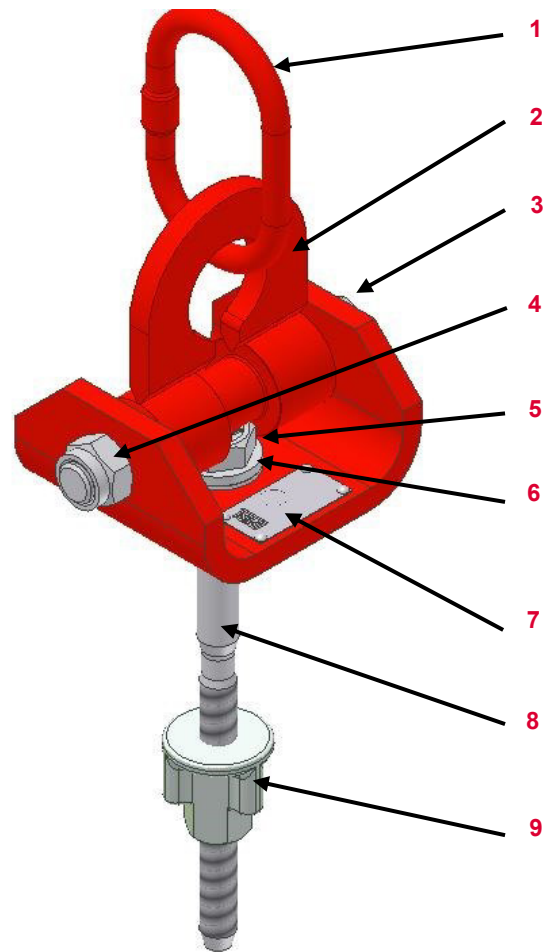

No.	Description	Article number
1	Crane suspension	
2	Crane eye	
3	Hex bolt	781051
4	Hex nut	781053
5	Washer	105513
6	Disc spring	781016
7	Type plate	710539
8	Column tie bolt	054230
9	Cam nut	030130

# PERI Rental Criteria

## QUATTRO Column Formwork















Crane hook	Description	Instruction	Billing condition	Type	
	<b>17.20.19 Type plate unreadable, lost</b>	 Type plate (710539) Grooved pin (767043)			
	<b>17.20.20 Suspension bracket</b>	<ul style="list-style-type: none"> <li>■ <math>\varnothing \leq 12,5 \text{ mm}</math></li> </ul>			
	<b>17.20.21 Crane suspension</b>	<ul style="list-style-type: none"> <li>■ <math>A \leq 22,5 \text{ mm}</math></li> </ul>			



# PERI Rental Criteria

## QUATTRO Column Formwork



Crane hook	Description	Instruction	Billing condition	Type
	17.20.22 Cam nut broken	 Cam nut (030130)		
	17.20.23 Column tie bolt bent, broken	 Column Tie bolt (054230)		
	17.20.24 Crane suspension	 Lubricate afterwards		

# PERI Rental Criteria

## QUATTRO Column Formwork













Ladder 180/6 (051410)	Description	Instruction	Billing condition	Type
	<p><b>17.20.25 Tread bent</b></p> <ul style="list-style-type: none"> <li>■ &gt; 3 mm</li> </ul>			
	<p><b>17.20.26 Weld torn</b></p> <ul style="list-style-type: none"> <li>■ Without deformation of basic material</li> <li>■ Or with deformation</li> </ul>	<p>Without deformation of basic material: </p> <p>Or with deformation: </p>	<p>Without deformation of basic material: </p> <p>Or with deformation: </p>	<p>Without deformation of basic material: </p> <p>Or with deformation: </p>

# PERI Rental Criteria

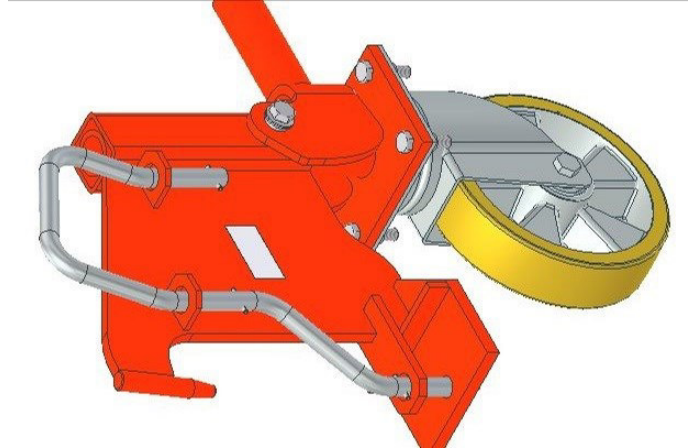
## QUATTRO Column Formwork



Transportation wheel QUATTRO (105791)	Description	Instruction	Billing condition	Type
	<p><b>17.20.27 Castor</b></p> <ul style="list-style-type: none"> <li>■ Worn</li> <li>■ Or damage by violent impacts</li> </ul>	<p>Castor (105783)</p>  <p>Castor (105783)</p> 	 	 
	<p><b>17.20.28 „Griff“ bent, broken</b></p>	 <p>Griff (105758) Sleeve (710683)</p>		

# PERI Rental Criteria

## QUATTRO Column Formwork



Column bolt set QUATTRO (037540)	Description	Instruction	Billing condition	Type
	17.20.29 Fork bent		088244	
	17.20.30 Three wingnut broken		Three wingnut (724811)	

# PERI Rental Criteria

## QUATTRO Column Formwork



Brace connector QUATTRO (037530)	No.	Description	Article number
----------------------------------	-----	-------------	----------------

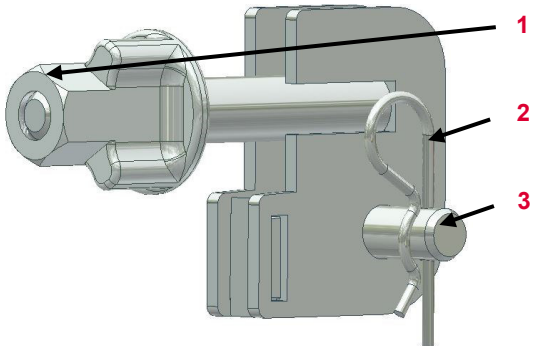

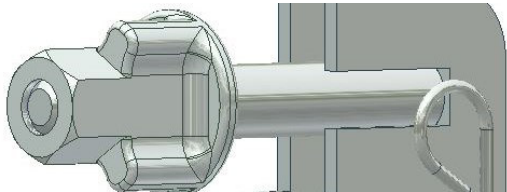

1	Cam nut	030130
2	Cotter pin	018060
3	Pin	027170

Damage	Description	Instruction	Billing Condition	Type
--------	-------------	-------------	-------------------	------



17.20.31 Cam nut broken

	Cam nut (030130)		088429	
---	------------------	---	--------	---

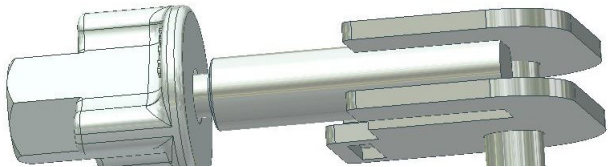

17.20.32 Bent

			088244	
---	--	---	--------	---

# PERI Rental Criteria

## QUATTRO Column Formwork



Ladder connection QUATTRO (103391)	No.	Description	Article number
------------------------------------	-----	-------------	----------------

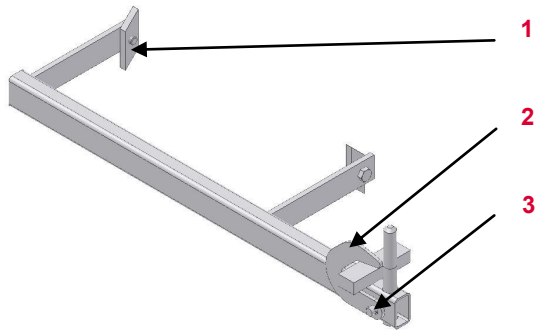

1	Clamping plate	701763
2	„Blechfalle“	104076
3	Sleeve	780803

Damage	Description	Instruction	Billing Condition	Type
--------	-------------	-------------	-------------------	------

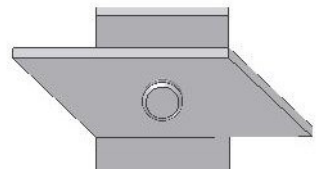

17.20.33 Clamping plate bent or broken

 Clamping plate (701763)  
Bolt (710266)

 088295

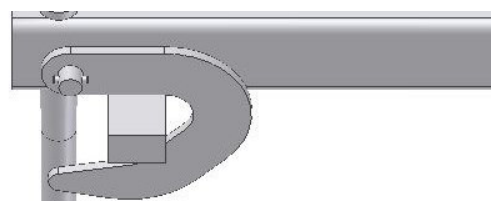

17.20.34 „Blechfalle“ bent, broken

 Blechfalle (104076)  
Sleeve (780803)

 088291





















# PERI Rental Criteria

## Glossar Icons



Icon	Bedeutung	Icon	Bedeutung	Icon	Bedeutung
	Not Ok—material is scrap		Billing necessary (customer)		Optical damage
	Ok—material stays in rental park		No Billing necessary		Functional damage
	Scrap material— it's not permitted to hand out the material because of safety aspects		Shorten the material		Functional damage—it's <b>not</b> permitted to hand out the material
	Repair according the Instruction		Mark the material		Static damage—it's <b>not</b> permitted to hand out the material
	Fix material cold– Afterwards check weld seams and bordering components		Replace damaged material		
	Repair after local economic efficiency calculation		Replace missing material		
	Clean the material				